

# MOSES



## Statistical Machine Translation System

### User Manual and Code Guide

Philipp Koehn  
pkoehn@inf.ed.ac.uk  
University of Edinburgh

#### Abstract

This document serves as user manual and code guide for the Moses machine translation decoder. The decoder was mainly developed by Hieu Hoang and Philipp Koehn at the University of Edinburgh and extended during a Johns Hopkins University Summer Workshop and further developed under EuroMatrix and GALE project funding. The decoder (which is part of a complete statistical machine translation toolkit) is the de facto benchmark for research in the field.

This document serves two purposes: a user manual for the functions of the Moses decoder and a code guide for developers. In large parts, this manual is identical to documentation available at the official Moses decoder web site <http://www.statmt.org/>. This document does not describe in depth the underlying methods, which are described in the text book *Statistical Machine Translation* (Philipp Koehn, Cambridge University Press, 2009).

August 8, 2016

## **Acknowledgments**

The Moses decoder was supported by the European Framework 6 projects EuroMatrix, TC-Star, the European Framework 7 projects EuroMatrixPlus, Let's MT, META-NET and MosesCore and the DARPA GALE project, as well as several universities such as the University of Edinburgh, the University of Maryland, ITC-irst, Massachusetts Institute of Technology, and others. Contributors are too many to mention, but it is important to stress the substantial contributions from Hieu Hoang, Chris Dyer, Josh Schroeder, Marcello Federico, Richard Zens, and Wade Shen. Moses is an open source project under the guidance of Philipp Koehn.

# Contents

<b>1</b>	<b>Introduction</b>	<b>11</b>
1.1	Welcome to Moses!	11
1.2	Overview	11
1.2.1	Technology	11
1.2.2	Components	12
1.2.3	Development	13
1.2.4	Moses in Use	14
1.2.5	History	14
1.3	Get Involved	14
1.3.1	Mailing List	14
1.3.2	Suggestions	15
1.3.3	Development	15
1.3.4	Use	15
1.3.5	Contribute	15
1.3.6	Projects	16
<b>2</b>	<b>Installation</b>	<b>23</b>
2.1	Getting Started with Moses	23
2.1.1	Easy Setup on Ubuntu (on other linux systems, you'll need to install packages that provide gcc, make, git, automake, libtool)	23
2.1.2	Compiling Moses directly with bjam	25
2.1.3	Other software to install	26
2.1.4	Platforms	27
2.1.5	Windows Installation	27
2.1.6	OSX Installation	28
2.1.7	Linux Installation	28
2.1.8	Run Moses for the first time	30
2.1.9	Chart Decoder	31
2.1.10	Next Steps	31
2.1.11	bjam options	31
2.2	Building with Eclipse	33
2.3	Baseline System	34
2.3.1	Overview	34
2.3.2	Installation	35
2.3.3	Corpus Preparation	36
2.3.4	Language Model Training	37
2.3.5	Training the Translation System	38

2.3.6	Tuning . . . . .	39
2.3.7	Testing . . . . .	40
2.3.8	Experiment Management System (EMS) . . . . .	43
2.4	Releases . . . . .	44
2.4.1	Release 3.0 (3rd Feb, 2015) . . . . .	44
2.4.2	Release 2.1.1 (3rd March, 2014) . . . . .	44
2.4.3	Release 2.1 (21th Jan, 2014) . . . . .	44
2.4.4	Release 1.0 (28th Jan, 2013) . . . . .	45
2.4.5	Release 0.91 (12th October, 2012) . . . . .	50
2.4.6	Status 11th July, 2012 . . . . .	50
2.4.7	Status 13th August, 2010 . . . . .	52
2.4.8	Status 9th August, 2010 . . . . .	53
2.4.9	Status 26th April, 2010 . . . . .	53
2.4.10	Status 1st April, 2010 . . . . .	53
2.4.11	Status 26th March, 2010 . . . . .	53
2.5	Work in Progress . . . . .	54
<b>3</b>	<b>Tutorials</b> . . . . .	<b>55</b>
3.1	Phrase-based Tutorial . . . . .	55
3.1.1	A Simple Translation Model . . . . .	55
3.1.2	Running the Decoder . . . . .	56
3.1.3	Trace . . . . .	57
3.1.4	Verbose . . . . .	58
3.1.5	Tuning for Quality . . . . .	62
3.1.6	Tuning for Speed . . . . .	63
3.1.7	Limit on Distortion (Reordering) . . . . .	66
3.2	Tutorial for Using Factored Models . . . . .	67
3.2.1	Train an unfactored model . . . . .	68
3.2.2	Train a model with POS tags . . . . .	69
3.2.3	Train a model with generation and translation steps . . . . .	72
3.2.4	Train a morphological analysis and generation model . . . . .	73
3.2.5	Train a model with multiple decoding paths . . . . .	74
3.3	Syntax Tutorial . . . . .	75
3.3.1	Tree-Based Models . . . . .	75
3.3.2	Decoding . . . . .	77
3.3.3	Decoder Parameters . . . . .	81
3.3.4	Training . . . . .	83
3.3.5	Using Meta-symbols in Non-terminal Symbols (e.g., CCG) . . . . .	86
3.3.6	Different Kinds of Syntax Models . . . . .	87
3.3.7	Format of text rule table . . . . .	92
3.4	Optimizing Moses . . . . .	93
3.4.1	Multi-threaded Moses . . . . .	93
3.4.2	How much memory do I need during decoding? . . . . .	94
3.4.3	How little memory can I get away with during decoding? . . . . .	96
3.4.4	Faster Training . . . . .	96
3.4.5	Training Summary . . . . .	98
3.4.6	Language Model . . . . .	99
3.4.7	Suffix array . . . . .	101

3.4.8	Cube Pruning . . . . .	102
3.4.9	Minimizing memory during training . . . . .	102
3.4.10	Minimizing memory during decoding . . . . .	102
3.4.11	Phrase-table types . . . . .	104
3.5	Experiment Management System . . . . .	105
3.5.1	Introduction . . . . .	105
3.5.2	Requirements . . . . .	106
3.5.3	Quick Start . . . . .	107
3.5.4	More Examples . . . . .	110
3.5.5	Try a Few More Things . . . . .	113
3.5.6	A Short Manual . . . . .	118
3.5.7	Analysis . . . . .	126
<b>4</b>	<b>User Guide</b> . . . . .	<b>131</b>
4.1	Support Tools . . . . .	131
4.1.1	Overview . . . . .	131
4.1.2	Converting Pharaoh configuration files to Moses configuration files . . .	131
4.1.3	Moses decoder in parallel . . . . .	131
4.1.4	Filtering phrase tables for Moses . . . . .	132
4.1.5	Reducing and Extending the Number of Factors . . . . .	132
4.1.6	Scoring translations with BLEU . . . . .	133
4.1.7	Missing and Extra N-Grams . . . . .	133
4.1.8	Making a Full Local Clone of Moses Model + ini File . . . . .	133
4.1.9	Absolutizing Paths in moses.ini . . . . .	134
4.1.10	Printing Statistics about Model Components . . . . .	134
4.1.11	Recaser . . . . .	135
4.1.12	Truecaser . . . . .	135
4.1.13	Searchgraph to DOT . . . . .	136
4.1.14	Threshold Pruning of Phrase Table . . . . .	137
4.2	External Tools . . . . .	138
4.2.1	Word Alignment Tools . . . . .	138
4.2.2	Evaluation Metrics . . . . .	141
4.2.3	Part-of-Speech Taggers . . . . .	142
4.2.4	Syntactic Parsers . . . . .	143
4.2.5	Other Open Source Machine Translation Systems . . . . .	145
4.2.6	Other Translation Tools . . . . .	146
4.3	User Documentation . . . . .	147
4.4	Advanced Models . . . . .	148
4.4.1	Lexicalized Reordering Models . . . . .	148
4.4.2	Operation Sequence Model (OSM) . . . . .	151
4.4.3	Class-based Models . . . . .	154
4.4.4	Multiple Translation Tables and Back-off Models . . . . .	155
4.4.5	Global Lexicon Model . . . . .	159
4.4.6	Desegmentation Model . . . . .	160
4.4.7	Advanced Language Models . . . . .	161
4.5	Efficient Phrase and Rule Storage . . . . .	161
4.5.1	Binary Phrase Tables with On-demand Loading . . . . .	161
4.5.2	Compact Phrase Table . . . . .	162

4.5.3	Compact Lexical Reordering Table . . . . .	165
4.5.4	Pruning the Translation Table . . . . .	165
4.5.5	Pruning the Phrase Table based on Relative Entropy . . . . .	166
4.5.6	Pruning Rules based on Low Scores . . . . .	170
4.6	Search . . . . .	170
4.6.1	Contents . . . . .	170
4.6.2	Generating n-Best Lists . . . . .	170
4.6.3	Minimum Bayes Risk Decoding . . . . .	172
4.6.4	Lattice MBR and Consensus Decoding . . . . .	172
4.6.5	Output Search Graph . . . . .	174
4.6.6	Early Discarding of Hypotheses . . . . .	176
4.6.7	Maintaining stack diversity . . . . .	176
4.6.8	Cube Pruning . . . . .	176
4.7	OOVs . . . . .	177
4.7.1	Contents . . . . .	177
4.7.2	Handling Unknown Words . . . . .	177
4.7.3	Unsupervised Transliteration Model . . . . .	178
4.8	Hybrid Translation . . . . .	180
4.8.1	Contents . . . . .	180
4.8.2	XML Markup . . . . .	180
4.8.3	Specifying Reordering Constraints . . . . .	182
4.8.4	Fuzzy Match Rule Table for Hierarchical Models . . . . .	183
4.8.5	Placeholder . . . . .	183
4.9	Moses as a Service . . . . .	186
4.9.1	Contents . . . . .	186
4.9.2	Moses Server . . . . .	186
4.9.3	Open Machine Translation Core (OMTC) - A proposed machine translation system standard . . . . .	187
4.10	Incremental Training . . . . .	188
4.10.1	Contents . . . . .	188
4.10.2	Introduction . . . . .	189
4.10.3	Initial Training . . . . .	189
4.10.4	Virtual Phrase Tables Based on Sampling Word-aligned Bitexts . . . . .	190
4.10.5	Updates . . . . .	191
4.10.6	Phrase Table Features for PhraseDictionaryBitextSampling . . . . .	193
4.10.7	Suffix Arrays for Hierarchical Models . . . . .	195
4.11	Domain Adaptation . . . . .	197
4.11.1	Contents . . . . .	197
4.11.2	Translation Model Combination . . . . .	198
4.11.3	OSM Model Combination (Interpolated OSM) . . . . .	199
4.11.4	Online Translation Model Combination (Multimodel phrase table type) . . . . .	200
4.11.5	Alternate Weight Settings . . . . .	202
4.11.6	Modified Moore-Lewis Filtering . . . . .	204
4.12	Constrained Decoding . . . . .	205
4.12.1	Contents . . . . .	205
4.12.2	Constrained Decoding . . . . .	205
4.13	Cache-based Models . . . . .	205
4.13.1	Contents . . . . .	205

4.13.2	Dynamic Cache-Based Phrase Table . . . . .	206
4.13.3	Dynamic Cache-Based Language Model . . . . .	211
4.14	Pipeline Creation Language (PCL) . . . . .	216
4.15	Obsolete Features . . . . .	219
4.15.1	Binary Phrase table . . . . .	219
4.15.2	Word-to-word alignment . . . . .	220
4.15.3	Binary Reordering Tables with On-demand Loading . . . . .	222
4.15.4	Continue Partial Translation . . . . .	222
4.15.5	Distributed Language Model . . . . .	223
4.15.6	Using Multiple Translation Systems in the Same Server . . . . .	226
4.16	Sparse Features . . . . .	227
4.16.1	Word Translation Features . . . . .	228
4.16.2	Phrase Length Features . . . . .	229
4.16.3	Domain Features . . . . .	230
4.16.4	Count Bin Features . . . . .	231
4.16.5	Bigram Features . . . . .	231
4.16.6	Soft Matching Features . . . . .	231
4.17	Translating Web pages with Moses . . . . .	232
4.17.1	Introduction . . . . .	232
4.17.2	Detailed setup instructions . . . . .	235
<b>5</b>	<b>Training Manual</b> . . . . .	<b>239</b>
5.1	Training . . . . .	239
5.1.1	Training process . . . . .	239
5.1.2	Running the training script . . . . .	240
5.2	Preparing Training Data . . . . .	240
5.2.1	Training data for factored models . . . . .	241
5.2.2	Cleaning the corpus . . . . .	241
5.3	Factored Training . . . . .	242
5.3.1	Translation factors . . . . .	242
5.3.2	Reordering factors . . . . .	243
5.3.3	Generation factors . . . . .	243
5.3.4	Decoding steps . . . . .	243
5.4	Training Step 1: Prepare Data . . . . .	243
5.5	Training Step 2: Run GIZA++ . . . . .	245
5.5.1	Training on really large corpora . . . . .	246
5.5.2	Training in parallel . . . . .	246
5.6	Training Step 3: Align Words . . . . .	247
5.7	Training Step 4: Get Lexical Translation Table . . . . .	250
5.8	Training Step 5: Extract Phrases . . . . .	250
5.9	Training Step 6: Score Phrases . . . . .	251
5.10	Training Step 7: Build reordering model . . . . .	254
5.11	Training Step 8: Build generation model . . . . .	256
5.12	Training Step 9: Create Configuration File . . . . .	256
5.13	Building a Language Model . . . . .	256
5.13.1	Language Models in Moses . . . . .	256
5.13.2	Enabling the LM OOV Feature . . . . .	258
5.13.3	Building a LM with the SRILM Toolkit . . . . .	258

5.13.4	On the IRSTLM Toolkit . . . . .	258
5.13.5	RandLM . . . . .	263
5.13.6	KenLM . . . . .	267
5.13.7	OxLM . . . . .	271
5.13.8	NPLM . . . . .	271
5.13.9	Bilingual Neural LM . . . . .	273
5.13.10	Bilingual N-gram LM (OSM) . . . . .	274
5.13.11	Dependency Language Model (RDLM) . . . . .	276
5.14	Tuning . . . . .	277
5.14.1	Overview . . . . .	277
5.14.2	Batch tuning algorithms . . . . .	277
5.14.3	Online tuning algorithms . . . . .	278
5.14.4	Metrics . . . . .	279
5.14.5	Tuning in Practice . . . . .	279
<b>6</b>	<b>Background</b>	<b>283</b>
6.1	Background . . . . .	283
6.1.1	Model . . . . .	284
6.1.2	Word Alignment . . . . .	285
6.1.3	Methods for Learning Phrase Translations . . . . .	286
6.1.4	Och and Ney . . . . .	286
6.2	Decoder . . . . .	289
6.2.1	Translation Options . . . . .	289
6.2.2	Core Algorithm . . . . .	290
6.2.3	Recombining Hypotheses . . . . .	291
6.2.4	Beam Search . . . . .	291
6.2.5	Future Cost Estimation . . . . .	293
6.2.6	N-Best Lists Generation . . . . .	294
6.3	Factored Translation Models . . . . .	296
6.3.1	Motivating Example: Morphology . . . . .	296
6.3.2	Decomposition of Factored Translation . . . . .	297
6.3.3	Statistical Model . . . . .	298
6.4	Confusion Networks Decoding . . . . .	301
6.4.1	Confusion Networks . . . . .	301
6.4.2	Representation of Confusion Network . . . . .	302
6.5	Word Lattices . . . . .	303
6.5.1	How to represent lattice inputs . . . . .	303
6.5.2	Configuring mooses to translate lattices . . . . .	304
6.5.3	Verifying PLF files with <code>checkplf</code> . . . . .	304
6.5.4	Citation . . . . .	305
6.6	Publications . . . . .	305
<b>7</b>	<b>Code Guide</b>	<b>307</b>
7.1	Code Guide . . . . .	307
7.1.1	Github, branching, and merging . . . . .	307
7.1.2	The code . . . . .	310
7.1.3	Quick Start . . . . .	311
7.1.4	Detailed Guides . . . . .	311



7.2	Coding Style . . . . .	311
7.2.1	Formatting . . . . .	311
7.2.2	Comments . . . . .	312
7.2.3	Data types and methods . . . . .	313
7.2.4	Source Control Etiquette . . . . .	314
7.3	Factors, Words, Phrases . . . . .	314
7.3.1	Factors . . . . .	314
7.3.2	Words . . . . .	315
7.3.3	Factor Types . . . . .	315
7.3.4	Phrases . . . . .	315
7.4	Tree-Based Model Decoding . . . . .	316
7.4.1	Looping over the Spans . . . . .	316
7.4.2	Looking up Applicable Rules . . . . .	317
7.4.3	Applying the Rules: Cube Pruning . . . . .	320
7.4.4	Hypotheses and Pruning . . . . .	322
7.5	Multi-Threading . . . . .	323
7.5.1	Tasks . . . . .	323
7.5.2	ThreadPool . . . . .	325
7.5.3	OutputCollector . . . . .	325
7.5.4	Not Deleting Threads after Execution . . . . .	326
7.5.5	Limit the Size of the Thread Queue . . . . .	326
7.5.6	Example . . . . .	326
7.6	Adding Feature Functions . . . . .	328
7.6.1	Video . . . . .	329
7.6.2	Other resources . . . . .	329
7.6.3	Feature Function . . . . .	329
7.6.4	Stateless Feature Function . . . . .	332
7.6.5	Stateful Feature Function . . . . .	333
7.6.6	Place-holder features . . . . .	334
7.6.7	moses.ini . . . . .	334
7.6.8	Examples . . . . .	335
7.7	Adding Sparse Feature Functions . . . . .	338
7.7.1	Implementation . . . . .	339
7.7.2	Weights . . . . .	339
7.8	Regression Testing . . . . .	340
7.8.1	Goals . . . . .	340
7.8.2	Test suite . . . . .	340
7.8.3	Running the test suite . . . . .	341
7.8.4	Running an individual test . . . . .	341
7.8.5	How it works . . . . .	341
7.8.6	Writing regression tests . . . . .	342
<b>8</b>	<b>Reference</b> . . . . .	<b>343</b>
8.1	Frequently Asked Questions . . . . .	343
8.1.1	My system is taking a really long time to translate a sentence. What can I do to speed it up ? . . . . .	343
8.1.2	The system runs out of memory during decoding. . . . .	343
8.1.3	I would like to point out a bug / contribute code. . . . .	343

8.1.4	How can I get an updated version of Moses ? . . . . .	344
8.1.5	What changed in the latest release of Moses? . . . . .	344
8.1.6	I am an undergrad/masters student looking for a project in SMT. What should I do? . . . . .	344
8.1.7	What do the 5 numbers in the phrase table mean? . . . . .	344
8.1.8	What OS does Moses run on? . . . . .	344
8.1.9	Can I use Moses on Windows ? . . . . .	345
8.1.10	Do I need a computer cluster to run experiments? . . . . .	345
8.1.11	I have compiled Moses, but it segfaults when running. . . . .	345
8.1.12	How do I add a new feature function to the decoder? . . . . .	345
8.1.13	Compiling with SRILM or IRSTLM produces errors. . . . .	345
8.1.14	I am trying to use Moses to create a web page to do translation. . . . .	346
8.1.15	How can a create a system that translate both ways, ie. X-to-Y as well as Y-to-X ? . . . . .	346
8.1.16	PhraseScore dies with signal 11 - why? . . . . .	346
8.1.17	Does Moses do Hierarchical decoding, like Hiero etc? . . . . .	347
8.1.18	Can I use Moses in proprietary software ? . . . . .	347
8.1.19	GIZA++ crashes with error "parameter 'cooccurrencefile' does not exist." . . . . .	347
8.1.20	Running regenerate-makefiles.sh gives me lots of errors about *GREP and *SED macros . . . . .	348
8.1.21	Running training I got the following error "*** buffer overflow detected ***: ../giza-pp/GIZA++-v2/GIZA++ terminated" . . . . .	348
8.1.22	I retrained my model and got different BLEU scores. Why? . . . . .	348
8.1.23	I specified ranges for mert weights, but it returned weights which are outwith those ranges . . . . .	348
8.1.24	Who do I ask if my question has not been answered by this FAQ? . . . . .	348
8.2	Reference: All Decoder Parameters . . . . .	349
8.3	Reference: All Training Parameters . . . . .	350
8.3.1	Basic Options . . . . .	351
8.3.2	Factored Translation Model Settings . . . . .	353
8.3.3	Lexicalized Reordering Model . . . . .	353
8.3.4	Partial Training . . . . .	353
8.3.5	File Locations . . . . .	354
8.3.6	Alignment Heuristic . . . . .	355
8.3.7	Maximum Phrase Length . . . . .	355
8.3.8	GIZA++ Options . . . . .	355
8.3.9	Dealing with large training corpora . . . . .	356
8.4	Glossary . . . . .	356

# 1

## Introduction

### 1.1 Welcome to Moses!

Moses is a **statistical machine translation system** that allows you to automatically train translation models for any language pair. All you need is a collection of translated texts (parallel corpus). Once you have a trained model, an efficient search algorithm quickly finds the highest probability translation among the exponential number of choices.

### 1.2 Overview

#### 1.2.1 Technology

Moses is an implementation of the **statistical** (or data-driven) approach to machine translation (MT). This is the dominant approach in the field at the moment, and is employed by the online translation systems deployed by the likes of Google and Microsoft. In statistical machine translation (SMT), translation systems are **trained** on large quantities of **parallel** data (from which the systems learn how to translate small segments), as well as even larger quantities of monolingual data (from which the systems learn what the target language should look like). Parallel data is a collection of sentences in two different languages, which is **sentence-aligned**, in that each sentence in one language is matched with its corresponding translated sentence in the other language. It is also known as a **bitext**.

The training process in Moses takes in the parallel data and uses cooccurrences of words and segments (known as **phrases**) to infer translation correspondences between the two languages of interest. In **phrase-based machine translation**, these correspondences are simply between continuous sequences of words, whereas in **hierarchical phrase-based machine translation** or **syntax-based translation**, more structure is added to the correspondences. For instance a hierarchical MT system could learn that the German *hat X gegessen* corresponds to the English *ate X*, where the Xs are replaced by any German-English word pair. The extra structure used in these types of systems may or may not be derived from a linguistic analysis of the parallel data. Moses also implements an extension of phrase-based machine translation known as **factored translation** which enables extra linguistic information to be added to a phrase-based systems.

For more information about the Moses translation models, please refer to the tutorials on phrase-based MT (Section 3.1), syntactic MT (Section 3.3) or factored MT (Section 3.2).

Whichever type of machine translation model you use, the key to creating a good system is lots of good quality data. There are many free sources of parallel data<sup>1</sup> which you can use to train sample systems, but (in general) the closer the data you use is to the type of data you want to translate, the better the results will be. This is one of the advantages to using an open-source tool like Moses, if you have your own data then you can tailor the system to your needs and potentially get better performance than a general-purpose translation system. Moses needs sentence-aligned data for its training process, but if data is aligned at the document level, it can often be converted to sentence-aligned data using a tool like hunalign<sup>2</sup>

## 1.2.2 Components

The two main components in Moses are the **training pipeline** and the **decoder**. There are also a variety of contributed tools and utilities. The training pipeline is really a collection of tools (mainly written in perl, with some in C++) which take the raw data (parallel and monolingual) and turn it into a machine translation model. The decoder is a single C++ application which, given a trained machine translation model and a source sentence, will translate the source sentence into the target language.

### The Training Pipeline

There are various stages involved in producing a translation system from training data, which are described in more detail in the training documentation (Section 5.1) and in the baseline system guide (Section 2.3). These are implemented as a pipeline, which can be controlled by the Moses experiment management system (Section 3.5), and Moses in general makes it easy to insert different types of external tools into the training pipeline.

The data typically needs to be prepared before it is used in training, tokenising the text and converting tokens to a standard case. Heuristics are used to remove sentence pairs which look to be misaligned, and long sentences are removed. The parallel sentences are then **word-aligned**, typically using GIZA++<sup>3</sup>, which implements a set of statistical models developed at IBM in the 80s. These word alignments are used to extract phrase-phrase translations, or hierarchical rules as required, and corpus-wide statistics on these rules are used to estimate probabilities.

An important part of the translation system is the **language model**, a statistical model built using monolingual data in the target language and used by the decoder to try to ensure the fluency of the output. Moses relies on external tools (Section 5.13) for language model building.

The final step in the creation of the machine translation system is **tuning** (Section 5.14), where the different statistical models are weighted against each other to produce the best possible translations. Moses contains implementations of the most popular tuning algorithms.

---

<sup>1</sup><http://www.statmt.org/moses/?n=Moses.LinksToCorpora>

<sup>2</sup><http://mokk.bme.hu/resources/hunalign/>

<sup>3</sup><http://code.google.com/p/giza-pp/>

## The Decoder

The job of the Moses decoder is to find the highest scoring sentence in the target language (according to the translation model) corresponding to a given source sentence. It is also possible for the decoder to output a ranked list of the translation candidates, and also to supply various types of information about how it came to its decision (for instance the phrase-phrase correspondences that it used).

The decoder is written in a modular fashion and allows the user to vary the decoding process in various ways, such as:

- **Input:** This can be a plain sentence, or it can be annotated with xml-like elements to guide the translation process, or it can be a more complex structure like a lattice or confusion network (say, from the output of speech recognition)
- **Translation model:** This can use phrase-phrase rules, or hierarchical (perhaps syntactic) rules. It can be compiled into a binarised form for faster loading. It can be supplemented with **features** to add extra information to the translation process, for instance features which indicate the sources of the phrase pairs in order to weight their reliability.
- **Decoding algorithm:** Decoding is a huge search problem, generally too big for exact search, and Moses implements several different strategies for this search, such as stack-based, cube-pruning, chart parsing etc.
- **Language model:** Moses supports several different language model toolkits (SRILM, KenLM, IRSTLM, RandLM) each of which has their own strengths and weaknesses, and adding a new LM toolkit is straightforward.

The Moses decoder also supports multi-threaded decoding (since translation is *embarrassingly parallelisable*<sup>4</sup>), and also has scripts to enable multi-process decoding if you have access to a cluster.

## Contributed Tools

There are many contributed tools in Moses which supply additional functionality over and above the standard training and decoding pipelines. These include:

- **Moses server:** which provides an xml-rpc interface to the decoder
- **Web translation:** A set of scripts to enable Moses to be used to translate web pages
- **Analysis tools:** Scripts to enable the analysis and visualisation of Moses output, in comparison with a reference.

There are also tools to evaluate translations, alternative phrase scoring methods, an implementation of a technique for weighting phrase tables, a tool to reduce the size of the phrase table, and other contributed tools.

### 1.2.3 Development

Moses is an open-source project, licensed under the LGPL<sup>5</sup>, which incorporates contributions from many sources. There is no formal management structure in Moses, so if you want to

---

<sup>4</sup>[http://en.wikipedia.org/wiki/Embarrassingly\\_parallel](http://en.wikipedia.org/wiki/Embarrassingly_parallel)

<sup>5</sup><http://www.gnu.org/copyleft/lesser.html>

contribute then just mail support<sup>6</sup> and take it from there. There is a list (Section 1.3) of possible projects on this website, but any new MT techniques are fair game for inclusion into Moses.

In general, the Moses administrators are fairly open about giving out push access to the git repository, preferring the approach of removing/fixing bad commits, rather than vetting commits as they come in. This means that trunk occasionally breaks, but given the active Moses user community, it doesn't stay broken for long. The nightly builds and tests of trunk are reported on the cruise control<sup>7</sup> web page, but if you want a more stable version then look for one of the releases (Section 2.4).

### 1.2.4 Moses in Use

The liberal licensing policy in Moses, together with its wide coverage of current SMT technology and complete tool chain, make it probably the most widely used open-source SMT system. It is used in teaching, research, and, increasingly, in commercial settings.

Commercial use of Moses is promoted and tracked by TAUS<sup>8</sup>. The most common current use for SMT in commercial settings is **post-editing** where machine translation is used as a first-pass, with the results then being edited by human translators. This can often reduce the time (and hence total cost) of translation. There is also work on using SMT in **computer-aided translation**, which is the research topic of two current EU projects, Casmacat<sup>9</sup> and MateCat<sup>10</sup>.

### 1.2.5 History

- 2005 Hieu Hoang (then student of Philipp Koehn) starts Moses as successor to Pharoah
- 2006 Moses is the subject of the JHU workshop, first check-in to public repository
- 2006 Start of Euromatrix, EU project which helps fund Moses development
- 2007 First machine translation marathon held in Edinburgh
- 2009 Moses receives support from EuromatrixPlus, also EU-funded
- 2010 Moses now supports hierarchical and syntax-based models, using chart decoding
- 2011 Moses moves from sourceforge to github, after over 4000 sourceforge check-ins
- 2012 EU-funded MosesCore launched to support continued development of Moses

*Subsection last modified on August 13, 2013, at 11:38 AM*

## 1.3 Get Involved

### 1.3.1 Mailing List

The main forum for communication on Moses is the Moses support mailing list<sup>11</sup>.

<sup>6</sup><http://www.statmt.org/moses/?n=Moses.MailingLists>

<sup>7</sup><http://www.statmt.org/moses/cruise/>

<sup>8</sup><http://www.translationautomation.com/user-cases/machines-takes-center-stage.html>

<sup>9</sup><http://www.casmacat.eu/>

<sup>10</sup><http://www.matecat.com/>

<sup>11</sup><http://www.statmt.org/moses/?n=Moses.MailingLists>

### 1.3.2 Suggestions

We'd like to hear what you want from Moses. We can't promise to implement the suggestions, but they can be used as input into research and student projects, as well as Marathon<sup>12</sup> projects. If you have a suggestion/wish for a new feature or improvement, then either report them via the issue tracker<sup>13</sup>, contact the mailing list or drop Barry or Hieu a line (addresses on the mailing list page).

### 1.3.3 Development

Moses is an open source project that is at home in the academic research community. There are several venues where this community gathers, such as:

- The main conferences in the field: ACL, EMNLP, MT Summit, etc.
- The annual ACL Workshop on Statistical Machine Translation<sup>14</sup>
- The annual Machine Translation Marathon<sup>15</sup>

Moses is being developed as a reference implementation of state-of-the-art methods in statistical machine translation. Extending this implementation may be the subject of undergraduate or graduate theses, or class projects. Typically, developers extend functionality that they required for their projects, or to explore novel methods. Let us know if you made an improvement, no matter how minor. Also let us know if you found or fixed a bug.

### 1.3.4 Use

We are aware of many commercial deployments of Moses, for instance as described by TAUS<sup>16</sup>. Please let us know if you use Moses commercially. Do not hesitate to contact the core developers of Moses. They are willing to answer questions and may be even available for consulting services.

### 1.3.5 Contribute

There are many ways you can contribute to Moses.

- To get started, build systems with your data and get familiar with how Moses works.
- Test out alternative settings for building a system. The shared tasks organized around the ACL Workshop on Statistical Machine Translation<sup>17</sup> are a good forum to publish such results on standard data conditions.
- Read the code. While you at it, feel free to add comments or contribute to the Code Guide (Section 7.1) to make it easier for others to understand the code.
- If you come across inefficient implementations (e.g., bad algorithms or code in Perl that should be ported to C++), program more efficient implementations.
- If you have new ideas for features, tools, and functionality, add them.
- Help out with some of the projects listed below.

<sup>12</sup><http://www.statmt.org/moses/?n=Moses.Marathons>

<sup>13</sup><https://github.com/moses-smt/mosesdecoder/issues>

<sup>14</sup><http://www.statmt.org/wmt14/>

<sup>15</sup><http://www.statmt.org/moses/?n=Moses.Marathons>

<sup>16</sup><http://www.translationautomation.com/user-cases/machines-takes-center-stage.html>

<sup>17</sup><http://www.statmt.org/wmt14/>

### 1.3.6 Projects

If you are looking for projects to improve Moses, please consider the following list:

#### Front-end Projects

- **OpenOffice/Microsoft Word, Excel or Access plugins:** (*Hieu Hoang*) Create wrappers for the Moses decoder to translate within user apps. Skills required - Windows, VBA, Moses. (GSOC)
- **Firefox, Chrome, Internet Explorer plugins:** (*Hieu Hoang*) Create a plugin that calls the Moses server to translate webpages. Skills required - Web design, Javascript, Moses. (GSOC)
- **Moses on the OLPC:** (*Hieu Hoang*) Create a front-end for the decoder, and possible the training pipeline, so that it can be run on the OLPC. Some preliminary work has been done here<sup>18</sup>
- **Rule-based numbers, currency, date translation:** (*Hieu Hoang*) SMT is bad at translating numbers and dates. Write some simple rules to identify and translate these for the language pairs of your choice. Integrate it into Moses and combine it with the placeholder feature<sup>19</sup>. Skills required - C++, Moses. (GSOC)
- **Named entity translation:** (*Hieu Hoang*) Text with lots of names and trademarks etc are difficult for SMT to translate. Integrate named entity recognition into Moses. Translate them using the transliteration phrase-table, placeholder feature, or a secondary phrase-table. Skills required - C++, Moses. (GSOC)
- **Interactive visualization for SCFG decoding:** (*Hieu Hoang*) Create a front-end to the hiero/syntax decoder that enables the user to re-translate a part of the sentence, change parameters in the decoder, add or delete translation rules etc. Skills required - C++, GUI, Moses. (GSOC)
- **Integrating the decoder with OCR/speech recognition input and speech synthesis output** (*Hieu Hoang*)

#### Training & Tuning

- **Incremental updating of translation and language model:** When you add new sentences to the training data, you don't want to re-run the whole training pipeline (do you?). Abby Levenberg has implemented incremental training<sup>20</sup> for Moses but what it lacks is a nice How-To guide.
- **Compression for Implz:** (*Kenneth Heafield*) Implz trains language models on disk. The temporary data on disk is not compressed, but it could be, especially with a fast compression algorithm like zippy. This will enable us to build much larger models. Skills required: C++. No SMT knowledge required. (GSOC)
- **Faster tuning by reuse:** In tuning, you constantly re-decode the same set of sentences and this can be very time-consuming. What if you could reuse part of the calculation each time? This has been previously proposed as a marathon project<sup>21</sup>

<sup>18</sup>[http://wiki.laptop.org/go/Projects/Automatic\\_translation\\_software](http://wiki.laptop.org/go/Projects/Automatic_translation_software)

<sup>19</sup><http://www.statmt.org/moses/?n=Moses.AdvancedFeatures#ntoc61>

<sup>20</sup><http://www.statmt.org/moses/?n=Moses.AdvancedFeatures#ntoc36>

<sup>21</sup><http://www.statmt.org/mtm12/index.php%3Fn=Projects.TargetHypergraphSerialization>



- **Use binary files to speed up phrase scoring:** Phrase-extraction and scoring involves a lot of processing of text files which is inefficient in both time and disk usage. Using binary files and vocabulary ids has the potential to make training more efficient, although more opaque.
- **Lattice training:** At the moment lattices can be used for decoding (Section 6.5), and also for MERT<sup>22</sup> but they can't be used in training. It would be pretty cool if they could be used for training, but this is far from trivial.
- **Training via forced decoding:** (*Matthias Huck*) Implement leave-one-out phrase model training in Moses. Skills required - C++, SMT.

<https://www-i6.informatik.rwth-aachen.de/publications/download/668/Wuebker-ACL-2010.pdf>

- **Faster training for the global lexicon model:** Moses implements the global lexicon model proposed by Mauser et al. (2009)<sup>23</sup>, but training features for each target word using a maximum entropy trainer is very slow (years of CPU time). More efficient training or accommodation of training of only frequent words would be useful.
- **Letter-based TER:** Implement an efficient version of letter-based TER as metric for tuning and evaluation, geared towards morphologically complex languages.
- **New Feature Functions:** Many new feature functions could be implemented and tested. For some ideas, see Green et al. (2014)<sup>24</sup>
- **Character count feature:** The word count feature is very valuable, but may be geared towards producing superfluous function words. To encourage the production of longer words, a character count feature could be useful. Maybe a unigram language model fulfills the same purpose.
- **Training with comparable corpora, related language, monolingual data:** (*Hieu Hoang*) High quality parallel corpora is difficult to obtain. There is a large amount of work on using comparable corpora, monolingual data, and parallel data in closely related languages to create translation models. This project will re-implement and extend some of the prior work.

### Chart-based Translation

- **Decoding algorithms for syntax-based models:** Moses generally supports a large set of grammar types. For some of these (for instance ones with source syntax, or a very large set of non-terminals), the implemented CYK+ decoding algorithm is not optimal. Implementing search algorithms for dedicated models, or just to explore alternatives, would be of great interest.
- **Source cardinality synchronous cube pruning for the chart-based decoder:** (*Matthias Huck*) Pooling hypotheses by amount of covered source words. Skills required - C++, SMT.

<http://www.dfki.de/~davi01/papers/vilar11:search.pdf>

- **Cube pruning for factored models:** Complex factored models with multiple translation and generation steps push the limits of the current factored model implementation which exhaustively computes all translations options up front. Using ideas from cube pruning (sorting the most likely rules and partial translation options) may be the basis for more efficient factored model decoding.

<sup>22</sup><http://www.statmt.org/moses/?n=Moses.AdvancedFeatures#ntoc33>

<sup>23</sup><http://aclweb.org/anthology/D/D09/D09-1022.pdf>

<sup>24</sup><http://www.aclweb.org/anthology/W14-3360.pdf>

- **Missing features for chart decoder:** A number of features are missing for the chart decoder, such as: MBR decoding (should be simple) and lattice decoding. In general, reporting and analysis within `experiment.perl` could be improved.
- **More efficient rule table for chart decoder:** (*Marcin*) The in-memory rule table for the hierarchical decoder loads very slowly and uses a lot of RAM. An optimized implementation that is vastly more efficient on both fronts should be feasible. Skills required - C++, NLP, Moses. (GSOC)
- **More features for incremental search:** Kenneth Heafield presented a faster search algorithm for chart decoding *Grouping Language Model Boundary Words to Speed K-Best Extraction from Hypergraphs* (NAACL 2013)<sup>25</sup>. This is implemented as a separate search algorithm in Moses (called 'incremental search'), but it lacks many features of the default search algorithm (such as sparse feature support, or support for multiple stateful features). Implementing these features for the incremental search would be of great interest.
- **Scope-0 grammar and phrase-table:** (*Hieu Hoang*). The most popular decoding algorithm for syntax MT is the CYK+ algorithm. This is a parsing algorithm which is able to use decoding with an unnormalized, unpruned grammar. However, the disadvantage of using such a general algorithm is its speed; Hopkins and Langmead (2010) showed that that a sentence of length  $n$  can be parsed using a scope- $k$  grammar in  $O(nk)$  chart update. For an unpruned grammar with 2 non-terminals (the usual SMT setup), the scope is 3.

This project proposes to quantify the advantages and disadvantages of scope-0 grammar. A scope-0 grammar lacks application ambiguity, therefore, decoding can be fast and memory efficient. However, this must be offset against potential translation quality degradation due to the lack of coverage.

It may be that the advantages of a scope-0 grammar can only be realized through specifically developed algorithms, such as parsing algorithms or data structures. The phrase-table lookup for a Scope-0 grammar can be significantly simplified, made faster, and applied to much large span width.

This project will also aim to explore this potentially rich research area.

<http://aclweb.org/anthology//W/W12/W12-3150.pdf>

[http://www.sdl.com/Images/emnlp2009\\_tcm10-26628.pdf](http://www.sdl.com/Images/emnlp2009_tcm10-26628.pdf)

### Phrase-based Translation

- **A better phrase table:** The current binarised phrase table suffers from (i) far too many layers of indirection in the code making it hard to follow and inefficient (ii) a cache-locking mechanism which creates excessive contention; and (iii) lack of extensibility meaning that (e.g.) word alignments were added on by extensively duplicating code and additional phrase properties are not available. A new phrase table could make Moses faster and more extensible.
- **Multi-threaded decoding:** Moses uses a simple "thread per sentence" model for multi-threaded decoding. However this means that if you have a single sentence to decode, then multi-threading will not get you the translation any faster. Is it possible to have a finer-grained threading model that can use multiple threads on a single sentence? This would call for a new approach to decoding.

<sup>25</sup>[http://kheafield.com/professional/edinburgh/search\\_paper.pdf](http://kheafield.com/professional/edinburgh/search_paper.pdf)

- **Better reordering:** (*Matthias Huck, Hieu Hoang*) E.g. with soft constraints on reordering: Moses currently allows you to specify hard constraints<sup>26</sup> on reordering, but it might be useful to have "soft" versions of these constraints. This would mean that the translation would incur a trainable penalty for violating the constraints, implemented by adding a feature function. Skills required - C++, SMT.

More ideas related to reordering:

<http://www.spencegreen.com/pubs/green+galley+manning.naacl10.pdf>

<http://www.transacl.org/wp-content/uploads/2013/07/paper327.pdf>

<https://www-i6.informatik.rwth-aachen.de/publications/download/444/Zens-COLING-2004.pdf>

<https://www-i6.informatik.rwth-aachen.de/publications/download/896/Feng-ACL-2013.pdf>

<http://research.google.com/pubs/archive/36484.pdf>

<http://research.google.com/pubs/archive/37163.pdf>

<http://research.google.com/pubs/archive/41651.pdf>

- **Merging the phrase table and lexicalized reordering table:** (*Matthias Huck, Hieu Hoang*) They contain the same source and target phrases, but different probabilities, and how those probabilities are applied. Merging the 2 models would halve the number of lookups. Skills required - C++, Moses. (GSOC)
- **Using artificial neural networks as memory to store the phrase table:** (*Hieu Hoang*) ANN can be used as associative memory to store information in a lossy method. [<http://ieeexplore.ieee.org/xpls/ab> It would be interesting to use them to how useful they are at store the phrase table. Further research can focus on how they can be used to store morphologically similar translations.
- **Entropy-based pruning:** (*Matthias Huck*) A more consistent method for pre-pruning phrase tables. Skills required - C++, NLP.

<http://research.google.com/pubs/archive/38279.pdf>

- **Faster phrase-based decoding by refining feature state:** Implement Heafield's *Faster Phrase-Based Decoding by Refining Feature State* (ACL 2014)<sup>27</sup>.
- **Multi-pass decoding:** (*Hieu Hoang*) Some features may be too expensive to use during decoding - maybe due to their computational cost, or due to their wider use of context which leads to more state splitting. Think of a recurrent neural network language model that both uses too much context (the entire output string) and is costly to compute. We would like to use these features in a reranking phase, but dumping out the search graph, and then re-decode it outside of Moses, creates a lot of additional overhead. So, it would be nicer to integrate second pass decoding within the decoder. This idea is related to coarse to fine decoding. Technically, we would like to be able to specify any feature function as a first pass or second pass feature function. There are some major issues that have to be tackled with multi-pass decoding:

1. A losing hypothesis which have been recombined with the winning hypothesis may now be the new winning hypothesis. The output search graph has to be reordered to reflect this.

<sup>26</sup><http://www.statmt.org/moses/?n=Moses.AdvancedFeatures#ntoc17>

<sup>27</sup>[http://kheafield.com/professional/stanford/mtplz\\_paper.pdf](http://kheafield.com/professional/stanford/mtplz_paper.pdf)

2. The feature functions in the 2nd pass produce state information. Recombined hypotheses may no longer be recombined and have to be split.
3. It would be useful for feature functions scores to be able to be evaluated asynchronously. That is, a function to calculate the score it called but the score is calculated later. Skills required - C++, NLP, Moses. (GSOC)

## General Framework & Tools

- **Out-of-vocabulary (OOV) word handling:** Currently there are two choices for OOVs - pass them through or drop them. Often neither is appropriate and Moses lacks good hooks to add new OOV strategies, and lacks alternative strategies. A new phrase table class should be created which process OOV. To create a new phrase-table type, make a copy of `moses/TranslationModel/SkeletonPT.*`, rename the class and follow the example in the file to implement your own code. Skills required - C++, Moses. (GSOC)
- **Tokenization for your language:** Tokenization is the only part of the basic SMT process that is language-specific. You can help make translation for your language better. Make a copy of the file `scripts/share/nonbreaking_prefixes/nonbreaking_prefix.en` and replace it with non-breaking words in your language. Skills required - SMT, Moses, lots of human languages. (GSOC)
- **Python interface:** A Python interface to the decoder could enable easy experimentation and incorporation into other tools. `cdec` has one<sup>28</sup> and Moses has a python interface to the on-disk phrase tables (implemented by Wilker Aziz) but it would be useful to be able to call the decoder from python.
- **Analysis of results:** (*Philipp Koehn*) Assessing the impact of variations in the design of a machine translation system by observing the fluctuations of the BLEU score may not be sufficiently enlightening. Having more analysis of the types of errors a system makes should be very useful.

## Engineering Improvements

- **Integration of sigfilter:** The filtering algorithm of Johnson et al<sup>29</sup> is available<sup>30</sup> in Moses, but it is not well integrated, has awkward external dependencies and so is seldom used. At the moment the code is in the `contrib` directory. A useful project would be to refactor this code to use the Moses libraries for suffix arrays, and to integrate it with the Moses experiment management system (EMS). The goal would be to enable the filtering to be turned on with a simple switch in the EMS config file.
- **Boostification:** Moses has allowed boost<sup>31</sup> since Autumn 2011, but there are still many areas of the code that could be improved by usage of the boost libraries, for instance using shared pointers in collections.
- **Cruise control:** Moses has cruise control<sup>32</sup> running on a server at the University of Edinburgh, however this only tests one platform (Ubuntu 12.04). If you have a different platform, and care about keeping Moses stable on that platform, then you could set up a cruise control instance too. The code is all in the standard Moses distribution.

<sup>28</sup><http://ufal.mff.cuni.cz/pbml/98/art-chahuneau-smith-dyer.pdf>

<sup>29</sup><http://aclweb.org/anthology/D/D07/D07-1103.pdf>

<sup>30</sup><http://www.statmt.org/moses/?n=Moses.AdvancedFeatures#ntoc16>

<sup>31</sup><http://www.boost.org>

<sup>32</sup><http://www.statmt.org/moses/cruise/>

**Documentation**

- **Maintenance:** The documentation always needs maintenance as new features are introduced and old ones are updated. Such a large body of documentation inevitably contains mistakes and inconsistencies, so any help in fixing these would be most welcome. If you want to work on the documentation, just introduce yourself on the mailing list.
- **Help messages:** Moses has a lot of executables, and often the help messages are quite cryptic or missing. A help message in the code is more likely to be maintained than separate documentation, and easier to locate when you're trying to find the right options. Fixing the help messages would be a useful contribution to making Moses easier to use.

*Subsection last modified on June 16, 2015, at 03:05 PM*



## 2

# Installation

## 2.1 Getting Started with Moses

This section will show you how to install and build Moses, and how to use Moses to translate with some simple models. If you experience problems, then please check the support<sup>1</sup> page. If you do not want to build Moses from source, then there are packages<sup>2</sup> available for Windows and popular Linux distributions.

### 2.1.1 Easy Setup on Ubuntu (on other linux systems, you'll need to install packages that provide gcc, make, git, automake, libtool)

1. Install required Ubuntu packages to build Moses and its dependencies:  

```
sudo apt-get install build-essential git-core pkg-config automake libtool wget  
zlib1g-dev python-dev libbz2-dev
```

For the regression tests, you'll also need  

```
sudo apt-get install libsoap-lite-perl
```

See below for additional packages that you'll need to actually run Moses (especially when you are using EMS).
2. Clone Moses from the repository and cd into the directory for building Moses  

```
git clone https://github.com/moses-smt/mosesdecoder.git  
cd mosesdecoder
```
3. Run the following to install a recent version of Boost (the default version on your system might be too old), as well as cmph (for CompactPT), irstlm (language model from FBK, required to pass the regression tests), and xmlrpc-c (for moses server). By default, these will be installed in `./opt` in your working directory:  

```
make -f contrib/Makefiles/install-dependencies.gmake
```
4. To compile moses, run  

```
./compile.sh [additional options]
```

---

<sup>1</sup><http://www.statmt.org/moses/?n=Moses.MailingLists>

<sup>2</sup><http://www.statmt.org/moses/?n=Moses.Packages>

**Popular additional bjam options (called from within `./compile.sh` and `./run-regtests.sh`):**

- `--prefix=/destination/path --install-scripts`  
... to install Moses somewhere else on your system
- `--with-mm`  
...to enable suffix array-based phrase tables<sup>3</sup>

**Note that you'll still need a word aligner; this is not built automatically**

**Running regression tests (Advanced; for Moses developers; normal users won't need this)**

To compile and run the regression tests all in one go, run  
`./run-regtests.sh [additional options]`

Regression testing is only of interest for people who are actively making changes in the Moses codebase. If you are just using Moses to run MT experiments, there's no point in running regression tests, unless you want to check that your current version of Moses is working as expected. However, you can also check your version against the daily regression tests here<sup>4</sup>.

If you run your own regression tests, sometimes Moses will fail them even when everything is working correctly, because different compilers produce slightly different executables that might produce slightly different output because they make different kinds of rounding errors.

### Manually installing Boost

Boost 1.48 has a serious bug which breaks Moses compilation. Unfortunately, some Linux distributions (eg. Ubuntu 12.04) have broken versions of the Boost library. In these cases, you must download and compile Boost yourself.

This is the exact commands I (Hieu) use to compile boost:

```
wget http://downloads.sourceforge.net/project/boost/boost/1.55.0/boost_1_55_0.tar.gz
tar zxvf boost_1_55_0.tar.gz
cd boost_1_55_0/
./bootstrap.sh
./b2 -j4 --prefix=$PWD --libdir=$PWD/lib64 --layout=system link=static install || echo FAILURE
```

This create library file in the directory `lib64`, NOT in the system directory. Therefore, you don't need to be system admin/root to run this. However, you will need to tell moses where to find boost, which is explained below

Once boost is installed, you can then compile Moses. However, you must tell Moses where boost is with the `--with-boost` flag. This is the exact commands I use to compile Moses:

<sup>3</sup><https://ufal.mff.cuni.cz/pbml/104/art-germann.pdf>

<sup>4</sup><http://statmt.org/moses/cruise>



```
./bjam --with-boost=~/.workspace/temp/boost_1_55_0 -j4
```

### 2.1.2 Compiling Moses directly with bjam

You may need to do this if

```
1. compile.sh doesn't work for you, for example,  
i. you're using OSX  
ii. you don't have all the prerequisites installed on your system so you want to compile Moses with a reduced number of features  
2. You want more control over exactly what options and features you want
```

To compile with bare minimum of features:

```
./bjam -j4
```

If you have compiled boost manually, then tell bjam where it is:

```
./bjam --with-boost=~/.workspace/temp/boost_1_55_0 -j8
```

If you have compiled the cmph library manually:

```
./bjam --with-cmph=/Users/hieu/workspace/cmph-2.0
```

If you have compiled the xmlrpc-c library manually:

```
./bjam --with-xmlrpc-c=/Users/hieu/workspace/xmlrpc-c/xmlrpc-c-1.33.17
```

If you have compiled the xmlrpc-c library manually:

```
./bjam --with-irstlm=/Users/hieu/workspace/irstlm/irstlm-5.80.08/trunk
```

This is the exact command I (Hieu) used on Linux:

```
./bjam --with-boost=/home/s0565741/workspace/boost/boost_1_57_0 --with-cmph=/home/s0565741/workspace/cmph-2.0 --with-irstlm=/home/s0565741/workspace/irstlm-code --with-
```

## Compiling on OSX

Recent versions of OSX have clang C/C++ compiler, rather than gcc. When compiling with bjam, you must add the following:

```
./bjam toolset=clang
```

This is the exact command I (Hieu) use on OSX Yosemite:

```
./bjam --with-boost=/Users/hieu/workspace/boost/boost_1_59_0 clang/ --with-cmph=/Users/hieu/workspace/cmph-2.0 --with-xmlrpc-c=/Users/hieu/workspace/xmlrpc-c/xmlrpc-c-1
```

You also need to add this argument when manually compiling boost. This is the exact command I use:

```
./b2 -j8 --prefix=$PWD --libdir=$PWD/lib64 --layout=system link=static toolset=clang install || echo FAILURE
```

### 2.1.3 Other software to install

#### Word Alignment

Moses requires a word alignment tool, such as giza++<sup>5</sup>, mgiza<sup>6</sup>, or Fast Align<sup>7</sup>.

I (Hieu) use MGIZA because it is multi-threaded and give general good result, however, I've also heard good things about Fast Align. You can find instructions to compile them here<sup>8</sup>.

<sup>5</sup><http://code.google.com/p/giza-pp/>

<sup>6</sup><https://github.com/moses-smt/mgiza>

<sup>7</sup>[https://github.com/clab/fast\\_align/blob/master/README.md](https://github.com/clab/fast_align/blob/master/README.md)

<sup>8</sup><http://www.statmt.org/moses/?n=Moses.ExternalTools#ntoc3>

## Language Model Creation

Moses includes the KenLM language model creation program, `lmplz`<sup>9</sup>.

You can also create language models with IRSTLM<sup>10</sup> and SRILM<sup>11</sup>. Please read this<sup>12</sup> if you want to compile IRSTLM. Language model toolkits perform two main tasks: training and querying. You can train a language model with any of them, produce an ARPA file, and query with a different one. To train a model, just call the relevant script.

If you want to use SRILM or IRSTLM to query the language model, then they need to be linked with Moses. For IRSTLM, you first need to compile IRSTLM then use the `--with-irstlm` switch to compile Moses with IRSTLM. This is the exact command I used:

```
./bjam --with-irstlm=/home/s0565741/workspace/temp/irstlm-5.80.03 -j4
```

Personally, I only use IRSTLM as a query tool in this way if the LM n-gram order is over 7. In most situation, I use KenLM because KenLM is multi-threaded and faster.

### 2.1.4 Platforms

The primary development platform for Moses is Linux, and this is the recommended platform since you will find it easier to get support for it. However Moses does work on other platforms:

### 2.1.5 Windows Installation

Moses can run on Windows under Cygwin. Installation is exactly the same as for Linux and Mac. (Are you running it on Windows? If so, please give us feedback on how it works). Cygwin is available as a 32-bit or a 64-bit application. Make sure you select the one that's appropriate for your machine. Remember 32-bit limits the size of the models Moses can use to a maximum of 4GB.

Install the following packages via Cygwin:

```
boost  
automake  
libtool  
cmake  
gcc-g++  
python
```

<sup>9</sup><http://www.statmt.org/moses/?n=FactoredTraining.BuildingLanguageModel#ntoc19>

<sup>10</sup><http://sourceforge.net/projects/irstlm/>

<sup>11</sup><http://www.speech.sri.com/projects/srilm/download.html>

<sup>12</sup><http://www.statmt.org/moses/?n=FactoredTraining.BuildingLanguageModel#ntoc4>

```
git
subversion
openssh
make
tcl
zlib0
zlib-devel
libbz2-devel
unzip
libexpat-devel
libcrypt-devel
```

Also, the nist-bleu script need a perl module called XML::Twig<sup>13</sup>. Install this in cygwin with the command

```
cpan
cpan XML::Twig
```

### 2.1.6 OSX Installation

Mac OSX is widely used by Moses developers and everything should run fine. Installation is the same as for Linux.

Mac OSX out-of-the-box doesn't have many programs that are critical to Moses, or different version of standard GNU programs. For example, `split`, `sort`, `zcat` are incompatible BSD-versions rather than GNU versions.

Therefore, Moses has been tested with Mac OSX with **Mac Ports**. Make sure you have this installed on your machine. Success has also been reported with `brew` installation. Do note, however, that you will need to install `xmlrpc-c` independently, and then compile with `bjam` using the `--with-xmlrpc-c=/usr/local` flag (where `/usr/local/` is the default location of the `xmlrpc-c` installation).

### 2.1.7 Linux Installation

#### Debian

Install the following packages using the command

```
su
apt-get install [package name]
```

<sup>13</sup><http://search.cpan.org/~mirod/XML-Twig-3.44/Twig.pm>

Packages:

```
git
subversion
make
libtool
gcc
g++
libboost-dev
tcl-dev
tk-dev
zlib1g-dev
libbz2-dev
python-dev
```

## Ubuntu

Install the following packages using the command

```
sudo apt-get install [package name]
```

Packages:

```
g++
git
subversion
automake
libtool
zlib1g-dev
libboost-all-dev
libbz2-dev
liblzma-dev
python-dev
graphviz
imagemagick
make
cmake
libgoogle-perftools-dev (for tcmalloc)
```

## Fedora / Redhat / CentOS / Scientific Linux

Install the following packages using the command

```
su
yum install [package name]
```

Packages:

```
git
subversion
automake
libtool
gcc-c++
zlib-devel
python-devel
bzip2-devel
boost-devel
```

### 2.1.8 Run Moses for the first time

Download the sample models and extract them into your working directory:

```
cd ~/mosesdecoder
wget http://www.statmt.org/moses/download/sample-models.tgz
tar xzf sample-models.tgz
cd sample-models
```

Run the decoder

```
cd ~/mosesdecoder/sample-models
~/mosesdecoder/bin/moses -f phrase-model/moses.ini < phrase-model/in > out
```

If everything worked out right, this should translate the sentence "das ist ein kleines haus" (in the file in) as "this is a small house" (in the file out).

Note that the configuration file `moses.ini` in each directory is set to use the KenLM language model toolkit by default. If you prefer to use IRSTLM<sup>14</sup>, then edit the language model entry in `moses.ini`, replacing `KENLM` with `IRSTLM`. You will also have to compile with `./bjam --with-irstlm`, adding the full path of your IRSTLM installation.

Moses also supports SRILM and RandLM language models. See here<sup>15</sup> for more details.

### 2.1.9 Chart Decoder

The chart decoder is part of the same executable as of version 3.0.

You can run the chart demos from the `sample-models` directory as follows

```
~/mosesdecoder/bin/moses -f string-to-tree/moses.ini < string-to-tree/in > out.stt
~/mosesdecoder/bin/moses -f tree-to-tree/moses.ini < tree-to-tree/in.xml > out.ttt
```

The expected result of the string-to-tree demo is

```
this is a small house
```

### 2.1.10 Next Steps

Why not try to build a Baseline (Section 2.3) translation system with freely available data?

### 2.1.11 bjam options

This is a list of options to `bjam`. On a system with Boost installed in a standard path, none should be required, but you may want additional functionality or control.

#### Optional packages

**Language models** In addition to KenLM and ORLM (which are always compiled):

`--with-irstlm=/path/to/irstlm` Path to IRSTLM installation

`--with-randlm=/path/to/randlm` Path to RandLM installation

`--with-nplm=/path/to/nplm` Path to NPLM installation

<sup>14</sup><http://hlt.fbk.eu/en/irstlm>

<sup>15</sup><http://www.statmt.org/moses/?n=FactoredTraining.BuildingLanguageModel#ntoc1>

**--with-srilm=/path/to/srilm** Path to SRILM installation.

If your SRILM install is non-standard, use these options:

**--with-srilm-dynamic** Link against srilm.so.

**--with-srilm-arch=arch** Override the arch setting given by /path/to/srilm/sbin/machine-type

### Other packages

**--with-boost=/path/to/boost** If Boost is in a non-standard location, specify it here. This directory is expected to contain include and lib or lib64.

**--with-xmlrpc-c=/path/to/xmlrpc-c** Specify a non-standard libxmlrpc-c installation path. Used by Moses server.

**--with-cmph=/path/to/cmph** Path where CMPH is installed. Used by the compact phrase table and compact lexical reordering table.

**--without-tcmalloc** Disable thread-caching malloc.

**--with-regtest=/path/to/moses-regression-tests** Run the regression tests using data from this directory. Tests can be downloaded from <https://github.com/moses-smt/moses-regression-tests>.

### Installation

**--prefix=/path/to/prefix** sets the install prefix [default is source root].

**--bindir=/path/to/prefix/bin** sets the bin directory [default is PREFIX/bin]

**--libdir=/path/to/prefix/lib** sets the lib directory [default is PREFIX/lib]

**--includedir=/path/to/prefix/include** installs headers. Does not install if missing. No argument defaults to PREFIX/include .

**--install-scripts=/path/to/scripts** copies scripts into a directory. Does not install if missing. No argument defaults to PREFIX/scripts .

**--git** appends the git revision to the prefix directory.

### Build Options

By default, the build is multi-threaded, optimized, and statically linked.

**threading=single|multi** controls threading (default multi)

**variant=release|debug|profile** builds optimized (default), for debug, or for profiling

**link=static|shared** controls preferred linking (default static)



**--static** forces static linking (the default will fall back to shared)  
**debug-symbols=on|off** include (default) or exclude debugging information also known as **-g**  
**--notrace** compiles without TRACE macros  
**--enable-boost-pool** uses Boost pools for the memory SCFG table  
**--enable-mpi** switch on mpi (used for MIRA - one of the tuning algorithms)  
**--without-libsefault** does not link with libSegFault  
**--max-kenlm-order** maximum ngram order that kenlm can process (default 6)  
**--max-factors** maximum number of factors (default 4)  
**--unlabelled-source** ignore source nonterminals (if you only use hierarchical or string-to-tree models without source syntax)

### Controlling the Build

**-q** quit on the first error  
**-a** to build from scratch  
**-j\$NCPUS** to compile in parallel  
**--clean** to clean

## 2.2 Building with Eclipse

There is a video showing you how to set up Moses with Eclipse.

```
{\bf How to compile Moses with Eclipse\footnote{\sf https://vimeo.com/129306919}}
```

Moses comes with Eclipse project files for some of the C++ executables. Currently, there are project files for

```
* moses (decoder)  
* moses-cmd (decoder)  
* extract  
* extract-rules  
* extract-ghkm  
* server  
* ...
```

The Eclipse build is used primarily for development and debugging. It is not optimized and doesn't have many of the options available in the bjam build.

The advantage of using Eclipse is that it offers code-completion, and a GUI debugging environment.

*NB.* The recent update of Mac OSX replaces g++ with clang. Eclipse doesn't yet fully function with clang. Therefore, you should not use the Eclipse build with any OSX version higher than 10.8 (Mountain Lion)

Follow these instructions to build with Eclipse:

```
* Use the version of Eclipse for C++. Works (at least) with Eclipse Kepler and Luna.
* Get the Moses source code
git clone git@github.com:moses-smt/mosesdecoder.git
cd mosesdecoder
* Create a softlink to Boost (and optionally to XMLRPC-C lib if you want to compile the moses server) in the Moses root directory
eg. ln -s ~/workspace/boost_x_xx_x boost
* Create a new Eclipse workspace. The workspace {\em MUST} be in
contrib/other-builds/
Eclipse should now be running.
* Import all the Moses Eclipse project into the workspace.
File >> Import >> Existing Projects into Workspace >> Select root directory: contrib/other-builds/ >> Finish
* Compile all projects.
Project >> Build All
```

*Subsection last modified on May 05, 2016, at 09:53 PM*

## 2.3 Baseline System

### 2.3.1 Overview

This guide assumes that you have successfully installed Moses (Section 2.1), and would like to see how to use parallel data to build a real phrase-based translation system. The process requires some familiarity with UNIX and, ideally, access to a Linux server. It can be run on a laptop, but could take about a day and requires at least 2G of RAM, and about 10G of free disk space (these requirements are just educated guesses, so if you have a different experience then please mail support<sup>16</sup>).

If you want to save the effort of typing in all the commands on this page (and see how the pros manage their experiments), then skip straight to the experiment management system (Section 2.3.8) instructions below. But I'd recommend that you follow through the process manually, at least once, just to see how it all works.

<sup>16</sup><http://www.statmt.org/moses/?n=Moses.MailingLists>

### 2.3.2 Installation

The minimum software requirements are:

- Moses (obviously!)
- GIZA++<sup>17</sup>, for word-aligning your parallel corpus
- IRSTLM<sup>18</sup>, SRILM<sup>19</sup>, OR KenLM<sup>20</sup> for language model estimation.

KenLM is included in Moses and the default in the Moses tool-chain. IRSTLM and KenLM are LGPL licensed (like Moses) and therefore available for commercial use.

For the purposes of this guide, I will assume that you're going to install all the tools and data in your home directory (i.e. ~/), and that you've already downloaded and compiled Moses into ~/mosesdecoder. And you're going to run Moses from there.

#### Installing GIZA++

GIZA++ is hosted at Google Code<sup>21</sup>, and a mirror of the original documentation can be found here<sup>22</sup>. I recommend that you download the latest version via svn:

```
git clone https://github.com/moses-smt/giza-pp.git
cd giza-pp
make
```

This should create the binaries ~/giza-pp/GIZA++-v2/GIZA++, ~/giza-pp/GIZA++-v2/snt2cooc.out and ~/giza-pp/mkcls-v2/mkcls. These need to be copied to somewhere that Moses can find them as follows

```
cd ~/mosesdecoder
mkdir tools
cp ~/giza-pp/GIZA++-v2/GIZA++ ~/giza-pp/GIZA++-v2/snt2cooc.out \
~/giza-pp/mkcls-v2/mkcls tools
```

When you come to run the training, you need to tell the training script where GIZA++ was installed using the `-external-bin-dir` argument.

---

<sup>17</sup><https://github.com/moses-smt/giza-pp>

<sup>18</sup><http://hlt.fbk.eu/en/irstlm>

<sup>19</sup><http://www.speech.sri.com/projects/srilm/download.html>

<sup>20</sup><http://kheafield.com/code/kenlm/estimation/>

<sup>21</sup><https://code.google.com/p/giza-pp/>

<sup>22</sup><http://www.statmt.org/moses/giza/GIZA++.html>

```
train-model.perl -external-bin-dir $HOME/mosesdecoder/tools
```

UPDATE - GIZA++ only compiles with gcc. If you're using OSX Mavericks, you'll have to install gcc yourself. I (Hieu) recommend using MGIZA instead

### 2.3.3 Corpus Preparation

To train a translation system we need parallel data (text translated into two different languages) which is aligned at the sentence level. Luckily there's plenty of this data freely available, and for this system I'm going to use a small (only 130,000 sentences!) data set released for the 2013 Workshop in Machine Translation. To get the data we want, we have to download the tarball and unpack it (into a corpus directory in our home directory) as follows

```
cd
mkdir corpus
cd corpus
wget http://www.statmt.org/wmt13/training-parallel-nc-v8.tgz
tar zxvf training-parallel-nc-v8.tgz
```

If you look in the ~/corpus/training directory you'll see that there's data from news-commentary (news analysis from project syndicate) in various languages. We're going to build a French-English (fr-en) translation system using the news commentary data set, but feel free to use one of the other language pairs if you prefer.

To prepare the data for training the translation system, we have to perform the following steps:

- **tokenisation:** This means that spaces have to be inserted between (e.g.) words and punctuation.
- **truecasing:** The initial words in each sentence are converted to their most probable casing. This helps reduce data sparsity.
- **cleaning:** Long sentences and empty sentences are removed as they can cause problems with the training pipeline, and obviously mis-aligned sentences are removed.

The tokenisation can be run as follows:

```
~/mosesdecoder/scripts/tokenizer/tokenizer.perl -l en \
< ~/corpus/training/news-commentary-v8.fr-en.en \
> ~/corpus/news-commentary-v8.fr-en.tok.en
~/mosesdecoder/scripts/tokenizer/tokenizer.perl -l fr \
< ~/corpus/training/news-commentary-v8.fr-en.fr \
> ~/corpus/news-commentary-v8.fr-en.tok.fr
```

The truecaser first requires training, in order to extract some statistics about the text:

```
~/mosesdecoder/scripts/recaser/train-truecaser.perl \
--model ~/corpus/truecase-model.en --corpus \
~/corpus/news-commentary-v8.fr-en.tok.en
~/mosesdecoder/scripts/recaser/train-truecaser.perl \
--model ~/corpus/truecase-model.fr --corpus \
~/corpus/news-commentary-v8.fr-en.tok.fr
```

Truecasing uses another script from the Moses distribution:

```
~/mosesdecoder/scripts/recaser/truecase.perl \
--model ~/corpus/truecase-model.en \
< ~/corpus/news-commentary-v8.fr-en.tok.en \
> ~/corpus/news-commentary-v8.fr-en.true.en
~/mosesdecoder/scripts/recaser/truecase.perl \
--model ~/corpus/truecase-model.fr \
< ~/corpus/news-commentary-v8.fr-en.tok.fr \
> ~/corpus/news-commentary-v8.fr-en.true.fr
```

Finally we clean, limiting sentence length to 80:

```
~/mosesdecoder/scripts/training/clean-corpus-n.perl \
~/corpus/news-commentary-v8.fr-en.true fr en \
~/corpus/news-commentary-v8.fr-en.clean 1 80
```

Notice that the last command processes both sides at once.

### 2.3.4 Language Model Training

The language model (LM) is used to ensure fluent output, so it is built with the target language (i.e English in this case). The KenLM documentation gives a full explanation of the command-line options, but the following will build an appropriate 3-gram language model.

```
mkdir ~/lm
cd ~/lm
~/mosesdecoder/bin/lmplz -o 3 <~/corpus/news-commentary-v8.fr-en.true.en > news-commentary-v8.fr-en.arpa.en
```

Then you should binarise (for faster loading) the \*.arpa.en file using KenLM:

```
~/mosesdecoder/bin/build_binary \  
news-commentary-v8.fr-en.arpa.en \  
news-commentary-v8.fr-en.blm.en
```

(Note that you can also use IRSTLM which also has a binary format that Moses supports. See the IRSTLM documentation for more information. For simplicity we only describe one approach here)

You can check the language model by querying it, e.g.

```
$ echo "is this an English sentence ?" \  
| ~/mosesdecoder/bin/query news-commentary-v8.fr-en.blm.en \  
Loading statistics: \  
Name:query      VmPeak:46788 kB VmRSS:30828 kB RSSMax:0 kB \  
user:0 sys:0 CPU:0 real:0.012207 \  
is=35 2 -2.6704 this=287 3 -0.889896 an=295 3 -2.25226 \  
English=7286 1 -5.27842 sentence=4470 2 -2.69906 \  
?=65 1 -3.32728 </s>=21 2 -0.0308115 Total: -17.1481 OOV: 0 \  
  
After queries: \  
Name:query      VmPeak:46796 kB VmRSS:30828 kB RSSMax:0 kB \  
user:0 sys:0 CPU:0 real:0.0129395 \  
Total time including destruction: \  
Name:query      VmPeak:46796 kB VmRSS:1532 kB RSSMax:0 kB \  
user:0 sys:0 CPU:0 real:0.0166016
```

### 2.3.5 Training the Translation System

Finally we come to the main event - training the translation model. To do this, we run word-alignment (using GIZA++), phrase extraction and scoring, create lexicalised reordering tables and create your Moses configuration file, all with a single command. I recommend that you create an appropriate directory as follows, and then run the training command, catching logs:

```
mkdir ~/working \  
cd ~/working \  
nohup nice ~/mosesdecoder/scripts/training/train-model.perl -root-dir train \  
-corpus ~/corpus/news-commentary-v8.fr-en.clean \  
-f fr -e en -alignment grow-diag-final-and -reordering msd-bidirectional-fe \  
-lm 0:3:$HOME/lm/news-commentary-v8.fr-en.blm.en:8 \  
-external-bin-dir ~/mosesdecoder/tools >& training.out &
```

If you have a multi-core machine it's worth using the `-cores` argument to encourage as much parallelisation as possible.

This took about 1.5 hours using 2 cores on a powerful laptop (Intel i7-2640M, 8GB RAM, SSD). Once it's finished there should be a `moses.ini` file in the directory `~/working/train/model`. You can use the model specified by this ini file to decode (i.e. translate), but there's a couple of problems with it. The first is that it's very slow to load, but we can fix that by *binarising* the phrase table and reordering table, i.e. compiling them into a format that can be load quickly. The second problem is that the weights used by Moses to weight the different models against each other are not optimised - if you look at the `moses.ini` file you'll see that they're set to default values like 0.2, 0.3 etc. To find better weights we need to *tune* the translation system, which leads us on to the next step...

### 2.3.6 Tuning

This is the slowest part of the process, so you might want to line up something to read whilst it's progressing. Tuning requires a small amount of parallel data, separate from the training data, so again we'll download some data kindly provided by WMT. Run the following commands (from your home directory again) to download the data and put it in a sensible place.

```
cd ~/corpus
wget http://www.statmt.org/wmt12/dev.tgz
tar zxvf dev.tgz
```

We're going to use `news-test2008` for tuning, so we have to tokenise and truecase it first (don't forget to use the correct language if you're not building a `fr->en` system)

```
cd ~/corpus
~/mosesdecoder/scripts/tokenizer/tokenizer.perl -l en \
< dev/news-test2008.en > news-test2008.tok.en
~/mosesdecoder/scripts/tokenizer/tokenizer.perl -l fr \
< dev/news-test2008.fr > news-test2008.tok.fr
~/mosesdecoder/scripts/recaser/truecase.perl --model truecase-model.en \
< news-test2008.tok.en > news-test2008.true.en
~/mosesdecoder/scripts/recaser/truecase.perl --model truecase-model.fr \
< news-test2008.tok.fr > news-test2008.true.fr
```

Now go back to the directory we used for training, and launch the tuning process:

```
cd ~/working
nohup nice ~/mosesdecoder/scripts/training/mert-moses.pl \
~/corpus/news-test2008.true.fr ~/corpus/news-test2008.true.en \
~/mosesdecoder/bin/moses train/model/moses.ini --mertdir ~/mosesdecoder/bin/ \
&> mert.out &
```

If you have several cores at your disposal, then it'll be a lot faster to run Moses multi-threaded. Add `--decoder-flags="-threads 4"` to the last line above in order to run the decoder with 4 threads. With this setting, tuning took about 4 hours for me.

The end result of tuning is an ini file with trained weights, which should be in `~/working/mert-work/moses.ini` if you've used the same directory structure as me.

### 2.3.7 Testing

You can now run Moses with

```
~/mosesdecoder/bin/moses -f ~/working/mert-work/moses.ini
```

and type in your favourite French sentence to see the results. You'll notice, though, that the decoder takes at least a couple of minutes to start-up. In order to make it start quickly, we can binarise the phrase-table and lexicalised reordering models. To do this, create a suitable directory and binarise the models as follows:

```
mkdir ~/working/binarised-model
cd ~/working
~/mosesdecoder/bin/processPhraseTableMin \
-in train/model/phrase-table.gz -nscores 4 \
-out binarised-model/phrase-table
~/mosesdecoder/bin/processLexicalTableMin \
-in train/model/reordering-table.wbe-msd-bidirectional-fe.gz \
-out binarised-model/reordering-table
```

Note: If you get the error `...~/mosesdecoder/bin/processPhraseTableMin: No such file or directory`, please make sure to compile Moses with CMPH<sup>23</sup>.

Then make a copy of the `~/working/mert-work/moses.ini` in the `binarised-model` directory and change the phrase and reordering tables to point to the binarised versions, as follows:

1. Change `PhraseDictionaryMemory` to `PhraseDictionaryCompact`

<sup>23</sup><http://www.statmt.org/moses/?n=Moses.AdvancedFeatures#ntoc8>



2. Set the path of the PhraseDictionary feature to point to \$HOME/working/binarised-model/phrase-table.
3. Set the path of the LexicalReordering feature to point to \$HOME/working/binarised-model/reordering-t

Loading and running a translation is pretty fast (for this I supplied the French sentence "faire revenir les militants sur le terrain et convaincre que le vote est utile.") :

```

Defined parameters (per moses.ini or switch):
config: binarised-model/moses.ini
distortion-limit: 6
feature: UnknownWordPenalty WordPenalty PhraseDictionaryCompact \
name=TranslationModel0 table-limit=20 num-features=5 \
path=/home/bhaddow/working/binarised-model/phrase-table \
input-factor=0 output-factor=0
LexicalReordering name=LexicalReordering0 \
num-features=6 type=wbe-msd-bidirectional-fe-allff \
input-factor=0 output-factor=0 \
path=/home/bhaddow/working/binarised-model/reordering-table \
Distortion KENLM lazyken=0 name=LM0 \
factor=0 path=/home/bhaddow/lm/news-commentary-v8.fr-en.blm.en order=3
input-factors: 0
mapping: 0 T 0
weight: LexicalReordering0= 0.119327 0.0221822 0.0359108 \
0.107369 0.0448086 0.100852 Distortion0= 0.0682159 \
LM0= 0.0794234 WordPenalty0= -0.0314219 TranslationModel0= 0.0477904 \
0.0621766 0.0931993 0.0394201 0.147903
/home/bhaddow/mosesdecoder/bin
line=UnknownWordPenalty
FeatureFunction: UnknownWordPenalty0 start: 0 end: 0
line=WordPenalty
FeatureFunction: WordPenalty0 start: 1 end: 1
line=PhraseDictionaryCompact name=TranslationModel0 table-limit=20 \
num-features=5 path=/home/bhaddow/working/binarised-model/phrase-table \
input-factor=0 output-factor=0
FeatureFunction: TranslationModel0 start: 2 end: 6
line=LexicalReordering name=LexicalReordering0 num-features=6 \
type=wbe-msd-bidirectional-fe-allff input-factor=0 output-factor=0 \
path=/home/bhaddow/working/binarised-model/reordering-table \
FeatureFunction: LexicalReordering0 start: 7 end: 12
Initializing LexicalReordering..
line=Distortion
FeatureFunction: Distortion0 start: 13 end: 13
line=KENLM lazyken=0 name=LM0 factor=0 \
path=/home/bhaddow/lm/news-commentary-v8.fr-en.blm.en order=3
FeatureFunction: LM0 start: 14 end: 14
binary file loaded, default OFF_T: -1
IO from STDOUT/STDIN
Created input-output object : [0.000] seconds
Translating line 0 in thread id 140592965015296

```

```

Translating: faire revenir les militants sur le terrain et          \
convaincre que le vote est utile .
reading bin ttable
size of OFF_T 8
binary phrasefile loaded, default OFF_T: -1
binary file loaded, default OFF_T: -1
Line 0: Collecting options took 0.000 seconds
Line 0: Search took 1.000 seconds
bring activists on the ground and convince that the vote is useful .
BEST TRANSLATION: bring activists on the ground and convince that   \
the vote is useful . [11111111111111] [total=-8.127]             \
core=(0.000,-13.000,-10.222,-21.472,-4.648,-14.567,6.999,-2.895,0.000, \
0.000,-3.230,0.000,0.000,0.000,-76.142)
Line 0: Translation took 1.000 seconds total
Name:moses VmPeak:214408 kB VmRSS:74748 kB                          \
RSSMax:0 kB user:0.000 sys:0.000 CPU:0.000 real:1.031

```

The translation ("bring activists on the ground and convince that the vote is useful.") is quite rough, but understandable - bear in mind this is a very small data set for general domain translation. Also note that your results may differ slightly due to non-determinism in the tuning process.

At this stage, you probably wondering how good the translation system is. To measure this, we use another parallel data set (the test set) distinct from the ones we've used so far. Let's pick newstest2011, and so first we have to tokenise and truecase it as before

```

cd ~/corpus
~/mosesdecoder/scripts/tokenizer/tokenizer.perl -l en \
< dev/newstest2011.en > newstest2011.tok.en
~/mosesdecoder/scripts/tokenizer/tokenizer.perl -l fr \
< dev/newstest2011.fr > newstest2011.tok.fr
~/mosesdecoder/scripts/recaser/truecase.perl --model truecase-model.en \
< newstest2011.tok.en > newstest2011.true.en
~/mosesdecoder/scripts/recaser/truecase.perl --model truecase-model.fr \
< newstest2011.tok.fr > newstest2011.true.fr

```

The model that we've trained can then be *filtered* for this test set, meaning that we only retain the entries needed translate the test set. This will make the translation a lot faster.

```

cd ~/working
~/mosesdecoder/scripts/training/filter-model-given-input.pl          \
filtered-newstest2011 mert-work/moses.ini ~/corpus/newstest2011.true.fr \
-Binarizer ~/mosesdecoder/bin/processPhraseTableMin

```

You can test the decoder by first translating the test set (takes a wee while) then running the BLEU script on it:

```
nohup nice ~/mosesdecoder/bin/moses          \
-f ~/working/filtered-newstest2011/moses.ini \
< ~/corpus/newstest2011.true.fr             \
> ~/working/newstest2011.translated.en      \
2> ~/working/newstest2011.out               \
~/mosesdecoder/scripts/generic/multi-bleu.perl \
-lc ~/corpus/newstest2011.true.en          \
< ~/working/newstest2011.translated.en
```

This gives me a BLEU score of 23.5 (in comparison, the best result at WMT11 was 30.5<sup>24</sup>, although it should be cautioned that this uses NIST BLEU, which does its own tokenisation, so there will be 1-2 points difference in the score anyway)

### 2.3.8 Experiment Management System (EMS)

If you've been through the effort of typing in all the commands, then by now you're probably wondering if there's an easier way. If you've skipped straight down here without bothering about the manual route then, well, you may have missed on a useful Moses "rite of passage".

The easier way is, of course, to use the EMS (Section 3.5). To use EMS, you'll have to install a few dependencies, as detailed on the EMS page, and then you'll need this config<sup>25</sup> file. Make a directory `~/working/experiments` and place the config file in there. If you open it up, you'll see the `home-dir` variable defined at the top - then make the obvious change. If you set the home directory, download the train, tune and test data and place it in the locations described above, then this config file should work.

To run EMS from the `experiments` directory, you can use the command:

```
nohup nice ~/mosesdecoder/scripts/ems/experiment.perl -config config -exec &> log &
```

then sit back and wait for the BLEU score to appear in `evaluation/report.1`

*Subsection last modified on January 23, 2016, at 05:36 PM*

<sup>24</sup>[http://matrix.statmt.org/matrix/systems\\_list/1669](http://matrix.statmt.org/matrix/systems_list/1669)

<sup>25</sup><http://www.statmt.org/moses/uploads/Moses/config>

## 2.4 Releases

### 2.4.1 Release 3.0 (3rd Feb, 2015)

This is the current stable release.

- Get the code on **github**<sup>26</sup>
- Download **Binaries**<sup>27</sup>
- Pre-made **models**<sup>28</sup>
- Virtual Machines **files**<sup>29</sup>
- Release **notes**<sup>30</sup>

### 2.4.2 Release 2.1.1 (3rd March, 2014)

This is a minor patch for a bug that prevent Moses from linking with tcmalloc when it is available on the compilation machine. Using tcmalloc can substantially speed up decoding, at the cost of more memory usage.

- Get the code on **github**<sup>31</sup>

### 2.4.3 Release 2.1 (21th Jan, 2014)

- Get the code on **github**<sup>32</sup>
- Download **Binaries**<sup>33</sup>

#### Overview

The broad aim of this release is to tackle more complicated issues to enable better expandability and reliability.

Specifically, the decoder has been refactored to create a more modular framework to enable easier incorporation of new feature functions into Moses. This has necessitate major changes in many other parts of the toolkit, including training and tuning.

As well as the refactored code, this release also incorporate a host of new features donated by other developers. Transliteration modules, better error handling, small and fast language models, and placeholders are just some of the new features that spring to mind.

We have also continue to expand the testing regime to maintain the reliability of the toolkit, while enable more developers to contribute to the project.

We distribute Moses as: 1. source code, 2. binaries for Windows (32 and 64 bit), Mac OSX (Mavericks), and various flavours of Linux (32 and 64 bit). 3. pre-installed in a Linux virtual machine, using the open source VirtualBox application. 4. Amazon cloud server image.

<sup>26</sup><https://github.com/moses-smt/mosesdecoder/tree/RELEASE-3.0>

<sup>27</sup><http://www.statmt.org/moses/RELEASE-3.0/binaries/>

<sup>28</sup><http://www.statmt.org/moses/RELEASE-3.0/models/>

<sup>29</sup><http://www.statmt.org/moses/RELEASE-3.0/vm/>

<sup>30</sup>[http://www.statmt.org/mosescore/uploads/Internal/D1.4\\_Moses\\_v3\\_Release\\_Notes.pdf](http://www.statmt.org/mosescore/uploads/Internal/D1.4_Moses_v3_Release_Notes.pdf)

<sup>31</sup><https://github.com/moses-smt/mosesdecoder/tree/RELEASE-2.1>

<sup>32</sup><https://github.com/moses-smt/mosesdecoder/tree/RELEASE-2.1>

<sup>33</sup><http://www.statmt.org/moses/RELEASE-2.1/binaries/>

### 2.4.4 Release 1.0 (28th Jan, 2013)

- Get the code on [github](https://github.com)<sup>34</sup>

#### Overview

The Moses community has grown tremendously over the last few years. From the beginning as a purely research-driven project, we are now a diverse community of academic and business users, ranging in experience from hardened developers to new users.

Therefore, the first priority of this release has been to concentrate on resolving long-standing, but straightforward, issues to make the toolkit easier to use and more efficient. The provision of full-time development team devoted to the maintenance and enhancement of the Moses toolkit has allowed us to tackle many useful engineering problems.

A second priority was to put in place a multi-tiered testing regime to enable more developers to contribute to the project, more quickly, while ensuring the reliability of the toolkit. However, we have not stopped adding new features to the toolkit; the next section lists a number of major features added in the last 9 months.

#### New Features

The following is a list of the major new features in the Moses toolkit since May 2012, in roughly chronological order.

**Parallel Training by Hieu Hoang and Rohit Gupta.** The training process has been improved and can take advantage of multi-core machines. Parallelization was achieved by partitioning the input data, then running the translation rule extraction processes in parallel before merging the data. The following is the timing for the extract process on different number of cores:

Cores	One	Two	Three	Four
Time taken (mins)	48:55	33:13	27:52	25:35

The training processes have also been redesigned to decrease disk access, and to use less disk space. This is important for parallel processing as disk IO often becomes the limiting factor with a large number of simultaneous disk access. It is also important when training syntactically inspired models or using large amounts of training data, which can result in very large translation models.

**IRST LM training integration by Hieu Hoang and Philipp Koehn** The IRST toolkit for training language models have been integrated into the Experiment Management System. The SRILM software previously carried out this functionality. Substituting IRST for SRI means that the entire training pipeline can be run using only free, open-source software. Not only is the IRST toolkit unencumbered by a proprietary license, it is also parallelizable and capable of training with a larger amount of data than was otherwise possible with SRI.

<sup>34</sup><https://github.com/amos-sm/amosdecoder/tree/RELEASE-1.0>

**Distributed Language Model by Oliver Wilson.** Language models can be distributed across many machines, allowing more data to be used at the cost of a performance overhead. This is still experimental code.

**Incremental Search Algorithm by Kenneth Heafield.** A replacement for the cube pruning algorithm in CKY++ decoding, used in hierarchical and syntax models. It offers better tradeoff between decoding speed and translation quality.

**Compressed Phrase-Table and Reordering-Tables by Marcin Junczys-Dowmunt.** A phrase-table and lexicalized reordering-table implementation which is both small and fast. More details<sup>35</sup>.

**Sparse features by Eva Hasler, Barry Haddow, Philipp Koehn** A framework to allow a large number of sparse features in the decoder. A number of sparse feature functions described in the literature have been reproduced in Moses. Currently, the available sparse feature functions are:

1. TargetBigramFeature
2. TargetNgramFeature
3. SourceWordDeletionFeature
4. SparsePhraseDictionaryFeature
5. GlobalLexicalModelUnlimited
6. PhraseBoundaryState
7. PhraseLengthFeature
8. PhrasePairFeature
9. TargetWordInsertionFeature

**Suffix array for hierarchical models by Hieu Hoang** The training of syntactically-inspired hierarchical models requires a large amount of time and resource. An alternative to training a translation is to only extract the required translation rules for each input sentence.

We have integrated Adam Lopez's suffix array implementation into Moses. This is a well-known and mature implementation, which is hosted and maintained by the cdec community.

### **Multi-threaded tokenizer by Pidong Wang**

**Batched MIRA by Colin Cherry.** A replacement for MERT, especially suited for tuning a large number of sparse features. (Cherry and Foster, NAACL 2012<sup>36</sup>).

**LR score by Lexi Birch and others.** The BLEU score commonly used in MT is insensitive to reordering errors. We have integrated another metric, LR score, described in (Birch and Osborne, 2011<sup>37</sup>) which better accounts for reordering, in the Moses toolkit.

<sup>35</sup><http://www.staff.amu.edu.pl/~junczys/images/7/7b/Mjd2012tsd1.pdf>

<sup>36</sup>[https://sites.google.com/site/colinacherry/Cherry\\_Foster\\_NAACL\\_2012.pdf](https://sites.google.com/site/colinacherry/Cherry_Foster_NAACL_2012.pdf)

<sup>37</sup><http://aclweb.org/anthology/P/P11/P11-1103.pdf>

**Convergence of Translation Memory and Statistical Machine Translation by Philipp Koehn and Hieu Hoang** An alternative extract algorithm, (Koehn, Senellart, 2010 AMTA<sup>38</sup>), which is inspired by the use of translation memories has been integrated into the Moses toolkit.

**Word Alignment Information is turned on by default by Hieu Hoang and Barry Haddow** The word alignment produced by GIZA++/mgiza is carried by the phrase-table and made available to the decoder. This information is required by some feature functions. The use of these word alignment is now optimized for memory and speed, and enabled by default.

**Modified Moore-Lewis filtering by Barry Haddow and Philipp Koehn** Reimplementation of domain adaptation of parallel corpus described by Axelrod et al. (EMNLP 2011)<sup>39</sup>.

**Lots and lots of cleanups and bug fixes** By Ales Tamchyna, Wilker Aziz, Mark Fishel, Tet-suo Kiso, Rico Sennrich, Lane Schwartz, Hiroshi Umemoto, Phil Williams, Tom Hoar, Arianna Bisazza, Jacob Dlougach, Jonathon Clark, Nadi Tomeh, Karel Bilek, Christian Buck, Oliver Wilson, Alex Fraser, Christophe Servan, Matous Machecek, Christian Federmann, Graham Neubig.

## Building and Installing

The structure and installation of the Moses toolkit has been simplified to make compilation and installation easier. The training and decoding process can be run from the directory in which the toolkit was downloaded, without the need for separate installation step.

This allows binary, ready-to-run versions of Moses to distributed which can be downloaded and executed immediately. Previously, the installation needed to be configured specifically for the user's machine.

A new build system has been implemented to build the Moses toolkit. This uses the boost library's build framework. The new system offers several advantages over the previous build system.

Firstly, the source code for the new build system is included in the Moses repository which is then bootstrapped the first time Moses is compiled. It does not rely on the the cmake, automake, make, and libtool applications. These have issues with cross-platform compatibility and running on older operating systems.

Secondly, the new build system integrates the running of the unit tests and regression tests with compilation.

Thirdly, the new system is significantly more powerful, allowing us to support a number of new build features such as static and debug compilation, linking to external libraries such as mpi and tmalloc, and other non-standard builds.

---

<sup>38</sup><http://www.mt-archive.info/AMTA-2010-Koehn.pdf>

<sup>39</sup><http://aclweb.org/anthology/D/D11/D11-1033.pdf>

## Testing

The MosesCore team has implemented several layers of testing to ensure the reliability of the toolkit. We describe each below.

**Unit Testing** Unit testing tests each function or class method in isolation. Moses uses the unit testing framework available from the Boost library to implement unit testing.

The source code for the unit tests are integrated into the Moses source. The tests are executed every time the Moses source is compiled.

The unit testing framework has recently been implemented. There are currently 20 unit tests for various features in mert, mira, phrase extraction, and decoding.

**Regression Testing** The regression tests ensure that changes to source code do not have unknown consequences to existing functionality. The regression tests are typically applied to a larger body of work than unit tests. They are designed to test specific functionality rather than a specific function. Therefore, regression tests are applied to the actual Moses programs, rather than tested in isolation.

The regression test framework forms the core of testing within the Moses toolkit. However, it was created many years ago at the beginning of the Moses project and was only designed to test the decoder. During the past 6 months, the scope of the regression test framework has been expanded to test any part of the Moses toolkit, in addition to testing the decoder. The test are grouped into the following types:

1. Phrase-based decoder
2. Hierarchical/Syntax decoder
3. Mert
4. Rule Extract
5. Phrase-table scoring
6. Miscellaneous, including domain adaptation features, binarizing phrase tables, parallel rule extract, and so forth.

The number of tests has increased from 46 in May 2012 to 73 currently.

We have also overhauled the regression test to make it easier to add new tests. Previously, the data for the regression tests could only be updated by developers who had access to the web server at Edinburgh University. This has now been changed so that the data now resides in a versioned repository on github.com<sup>40</sup>.

This can be accessed and changed by any Moses developer, and is subject to the same checks and controls as the rest of the Moses source code.

Every Moses developer is obliged to ensure the regression test are successfully executed before they commit their changes to the master repository.

---

<sup>40</sup><https://github.com/moses-smt/moses-regression-tests>



**Cruise Control** This is a daily task run on a server at the University of Edinburgh which compiles the Moses source code and executes the unit tests and regressions tests. Additionally, it also runs a small training pipeline to completion. The results of this testing is publicly available online<sup>41</sup>.

This provides an independent check that all unit tests and regression tests passed, and that the entirety of the SMT pipeline is working. Therefore, it tests not only the Moses toolkit, but also external tools such as GIZA++ that are essential to Moses and the wider SMT community.

All failures are investigated by the MosesCore team and any remedial action is taken. This is done to enforce the testing regime and maintain reliability.

The cruise control is a subproject of Moses initiated by Ales Tamchyna with contribution by Barry Haddow.

### Operating-System Compatibility

The Moses toolkit has always strived to be compatible on multiple platforms, particularly on the most popular operating systems used by researchers and commercial users.

Before each release, we make sure that Moses compiles and the unit tests and regression test successfully runs on various operating systems.

Moses, GIZA++ mgiza, and IRSTLM was compiled for

1. Linux 32-bit
2. Linux 64-bit
3. Cygwin
4. Mac OSX 10.7 64-bit

Effort was made to make the executables runnable on as many platforms as possible. Therefore, they were statically linked when possible. Moses was then tested on the following platforms:

1. Windows 7 (32-bit) with Cygwin 6.1
2. Mac OSX 10.7 with MacPorts
3. Ubuntu 12.10, 32 and 64-bit
4. Debian 6.0, 32 and 64-bit
5. Fedora 17, 32 and 64-bit
6. openSUSE 12.2, 32 and 64-bit

All the binary executables are made available for download<sup>42</sup> for users who do not wish to compile their own version.

GIZA++, mgiza, and IRSTLM are also available for download as binaries to enable users to run the entire SMT pipeline without having to download and compile their own software.

Issues:

1. IRSTLM was not linked statically. The 64-bit version fails to execute on Debian 6.0. All other platforms can run the downloaded executables without problem.
2. Mac OSX does not support static linking. Therefore, it is not known if the executables would work on any other platforms, other than the one on which it was tested.
3. mgiza compilation failed on Mac OSX with gcc v4.2. It could only be successfully compiled with gcc v4.5, available via MacPorts.

---

<sup>41</sup><http://www.statmt.org/moses/cruise/>

<sup>42</sup><http://www.statmt.org/moses/RELEASE-1.0/binaries/>

**End-to-End Testing** Before each Moses release, a number of full scale experiments are run. This is the final test to ensure that the Moses pipeline can run from beginning to end, uninterrupted, with "real-world" datasets. The translation quality, as measured by BLEU, is also noted, to ensure that there is no decrease in performance due to any interaction between components in the pipeline.

This testing takes approximately 2 weeks to run. The following datasets and experiments are currently used for end-to-end testing:

- Europarl en-es: phrase-based, hierarchical
- Europarl en-es: phrase-based, hierarchical
- Europarl cs-en: phrase-based, hierarchical
- Europarl en-cs: phrase-based, hierarchical
- Europarl de-en: phrase-based, hierarchical, factored German POS, factored German+English POS
- Europarl en-de: phrase-based, hierarchical, factored German POS, factored German+English POS
- Europarl fr-en: phrase-based, hierarchical, recased (as opposed to truecased), factored English POS
- Europarl en-fr: phrase-based, hierarchical, recased (as opposed to truecased), factored English POS

**Pre-Made Models** The end-to-end tests produces a large number of tuned models. The models, as well as all configuration and data files, are made available for download<sup>43</sup>. This is useful as a template for users setting up their own experimental environment, or for those who just want the models without running the experiments.

#### 2.4.5 Release 0.91 (12th October, 2012)

The code is available in a branch on [github](#)<sup>44</sup>.

This version was tested on 8 Europarl language pairs, phrase-based, hierarchical, and phrase-base factored models. All runs through without major intervention. Known issues:

1. Hierarchical models crashes on evaluation when threaded. Strangely, run OK during tuning
2. EMS bugs when specifying multiple language models
3. Complex factored models not tested
4. Hierarchical models with factors does not work

#### 2.4.6 Status 11th July, 2012

A roundup of the new features that have been implemented in the past year:

1. Lexi Birch's LR score integrated into tuning. Finished coding: YES. Tested: NO. Documented: NO. Developer: Hieu, Lexi. First/Main user: Yvette Graham.

<sup>43</sup><http://www.statmt.org/moses/RELEASE-1.0/models/>

<sup>44</sup><https://github.com/moses-smt/mosesdecoder/tree/RELEASE-0.91>

2. Asynchronous, batched LM requests for phrase-based models. Finished coding: YES. Tested: UNKNOWN. Documented: YES. Developer: Oliver Wilson, Miles Osborne. First/Main user: Miles Osborne.
3. Multithreaded tokenizer. Finished coding: YES. Tested: YES. Documented: NO. Developer: Pidong Wang.
4. KB Mira. Finished coding: YES. Tested: YES. Documented: YES. Developer: Colin Cherry.
5. Training & decoding more resilient to non-printing characters and Moses' reserved characters. Escaping the reserved characters and throwing away lines with non-printing chars. Finished coding: YES. Tested: YES. Documented: NO. Developer: Philipp Koehn and Tom Hoar.
6. Simpler installation. Finished coding: YES. Tested: YES. Documented: YES. Developer: Hieu Hoang. First/Main user: Hieu Hoang.
7. Factors work with chart decoding. Finished coding: YES. Tested: NO. Documented: NO. Developer: Hieu Hoang. First/Main user: Fabienne Braune.
8. Less IO and disk space needed during training. Everything written directly to gz files. Finished coding: YES. Tested: YES. Documented: NO. Developer: Hieu. First/Main user: Hieu.
9. Parallel training. Finished coding: YES. Tested: YES. Documented: YES. Developer: Hieu. First/Main user: Hieu
10. Adam Lopez's suffix array integrated into Moses's training & decoding. Finished coding: YES. Tested: NO. Documented: YES. Developer: Hieu.
11. Major MERT code cleanup. Finished coding: YES. Tested: NO. Documented: NO. Developer: Tetsuo Kiso.
12. Wrapper for Berkeley parser (german). Finished coding: YES. Tested: UNKNOWN. Documented: UNKNOWN. Developer: Philipp Koehn.
13. Option to use  $p(\text{RHS}_t|\text{RHS}_s,\text{LHS})$  or  $p(\text{LHS},\text{RHS}_t|\text{RHS}_s)$ , as a grammar rule's direct translation score. Finished coding: YES. Tested: UNKNOWN. Documented: UNKNOWN. Developer: Philip Williams. First/Main user: Philip Williams.
14. Optional PCFG scoring feature for target syntax models. Finished coding: YES. Tested: UNKNOWN. Documented: UNKNOWN. Developer: Philip Williams. First/Main user: Philip Williams.
15. Add `-snt2cooc` option to use mgiza's reduced memory `snt2cooc` program. Finished coding: YES. Tested: YES. Documented: YES. Developer: Hieu Hoang.
16. `queryOnDiskPt` program. Finished coding: YES. Tested: YES. Documented: NO. Developer: Hieu Hoang. First/Main user: Daniel Schaut.
17. Output phrase segmentation to n-best when `-report-segmentation` is used. Finished coding: YES. Tested: UNKNOWN. Developer: UNKNOWN. First/Main user: Jonathon Clark.
18. CDER and WER metric in tuning. Finished coding: UNKNOWN. Tested: UNKNOWN. Documented: UNKNOWN. Developer: Matous Machacek.
19. Lossy Distributed Hash Table Language Model. Finished coding: UNKNOWN. Tested: UNKNOWN. Documented: UNKNOWN. Developer: Oliver Wilson.
20. Interpolated scorer for MERT. Finished coding: YES. Tested: UNKNOWN. Documented: UNKNOWN. Developer: Matous Machacek.
21. IRST LM training integrated into Moses. Finished coding: YES. Tested: YES. Documented: YES. Developer: Hieu Hoang.
22. `GlobalLexiconModel`. Finished coding: UNKNOWN. Tested: UNKNOWN. Documented:

- UNKNOWN. Developer: Jiri Marsik, Christian Buck and Philipp Koehn.
23. TM Combine (translation model combination). Finished coding: YES. Tested: YES. Documented: YES. Developer: Rico Sennrich.
  24. Alternative to CKY+ for scope-3 grammar. Reimplementation of Hopkins and Langmead (2010). Finished coding: YES. Tested: UNKNOWN. Documented: UNKNOWN. Developer: Philip Williams.
  25. Sample Java client for Moses server. Finished coding: YES. Tested: NO. Documented: NO. Developer: Marwen Azouzi. First/Main user: Mailing list users.
  26. Support for mgiza, without having to install GIZA++ as well. Finished coding: YES. Tested: YES. Documented: NO. Developer: Marwen Azouzi.
  27. Interpolated language models. Finished coding: YES. Tested: YES. Documented: YES. Developer: Philipp Koehn.
  28. Duplicate removal in MERT. Finished coding: YES. Tested: YES. Documented: NO. Developer: Thomas Schoenemann.
  29. Use bjam instead of automake to compile. Finished coding: YES. Tested: YES. Documented: YES. Developer: Ken Heafield.
  30. Recaser train script updated to support IRSTLM as well. Finished coding: YES. Tested: YES. Documented: YES. Developer: Jehan.
  31. `extract-ghkm`. Finished coding: UNKNOWN. Tested: UNKNOWN. Documented: UNKNOWN. Developer: Philip Williams.
  32. PRO tuning algorithm. Finished coding: YES. Tested: YES. Documented: YES. Developer: Philipp Koehn and Barry Haddow.
  33. Cruise control. Finished coding: YES. Tested: YES. Documented: YES. Developer: Ales Tamchyna.
  34. Faster SCFG rule table format. Finished coding: YES. Tested: UNKNOWN. Documented: NO. Developer: Philip Williams.
  35. LM OOV feature. Finished coding: YES. Tested: UNKNOWN. Documented: NO. Developer: Barry Haddow and Ken Heafield.
  36. TER Scorer in MERT. Finished coding: UNKNOWN. Tested: UNKNOWN. Documented: NO. Developer: Matous Machacek & Christophe Servan.
  37. Multi-threading for decoder & MERT. Finished coding: YES. Tested: YES. Documented: YES. Developer: Barry Haddow et al.
  38. Expose n-gram length as part of LM state calculation. Finished coding: YES. Tested: UNKNOWN. Documented: NO. Developer: Ken Heafield and Marc Legendre.
  39. Changes to chart decoder cube pruning: create one cube per dotted rule instead of one per translation. Finished coding: YES. Tested: YES. Documented: NO. Developer: Philip Williams.
  40. Syntactic LM. Finished coding: YES. Tested: YES. Documented: YES. Developer: Lane Schwartz.
  41. Czech detokenization. Finished coding: YES. Tested: UNKNOWN. Documented: UNKNOWN. Developer: Ondrej Bojar.

#### 2.4.7 Status 13th August, 2010

Changes since the last status report:

1. change or delete character  $\emptyset$  to 0 in `extract-rules.cpp` (Raphael and Hieu Hoang)

### 2.4.8 Status 9th August, 2010

Changes since the last status report:

1. Add option of retaining alignment information in the phrase-based phrase table. Decoder loads this information if present. (Hieu Hoang & Raphael Payen)
2. When extracting rules, if the source or target syntax contains an unsupported escape sequence (anything other than "<", ">", "&", "&apos;", and "&quot;") then write a warning message and skip the sentence pair (instead of asserting).
3. In bootstrap-hypothesis-difference-significance.pl, calculates the p-value and confidence intervals not only using BLEU, but also the NIST score. (Mark Fishel)
4. Dynamic Suffix Arrays (Abby Levenberg)
5. Merge multi-threaded Moses into Moses (Barry Haddow)
6. Continue partial translation (Ondrej Bojar and Ondrej Odchazel)
7. Bug fixes, minor bits & bobs. (Philipp Koehn, Christian Hardmeier, Hieu Hoang, Barry Haddow, Philip Williams, Ondrej Bojar, Abbey, Mark Mishel, Lane Schwartz, Nicola Bertoldi, Raphael, ...)

### 2.4.9 Status 26th April, 2010

Changes since the last status report:

1. Synchronous CFG based decoding, a la Hiero (Chiang 2005), plus with syntax. And all the scripts to go with it. (Thanks to Philip Williams and Hieu Hoang)
2. caching clearing in IRST LM (Nicola Bertoldi)
3. Factored Language Model. (Ondrej Bojar)
4. Fixes to lattice (Christian Hardmeier, Arianna Bisazza, Suzy Howlett)
5. zmert (Ondrej Bojar)
6. Suffix arrays (Abby Levenberg)
7. Lattice MBR and consensus decoding (Barry Haddow and Abhishek Arun)
8. Simple program that illustrates how to access a phrase table on disk from an external program (Felipe Sánchez-Martínez)
9. Odds and sods by Raphael Payen and Sara Stymne.

### 2.4.10 Status 1st April, 2010

Changes since the last status report:

1. Fix for Visual Studio, and potentially other compilers (thanks to Barry, Christian, Hieu)
2. Memory leak in unique n-best fixed (thanks to Barry)
3. Makefile fix for Moses server (thanks to Barry)

### 2.4.11 Status 26th March, 2010

Changes since the last status report:

1. Minor bug fixes & tweaks, especially to the decoder, MERT scripts (thanks to too many people to mention)

2. Fixes to make decoder compile with most versions of gcc, Visual studio and other compilers (thanks to Tom Hoar, Jean-Bapist Fouet).
3. Multi-threaded decoder (thanks to Barry Haddow)
4. Update for IRSTLM (thanks to Nicola Bertoldi and Marcello Federico)
5. Run mert on a subset of features (thanks to Nicola Bertoldi)
6. Training using different alignment models (thanks to Mark Fishel)
7. "A handy script to get many translations from Google" (thanks to Ondrej Bojar)
8. Lattice MBR (thanks to Abhishek Arun and Barry Haddow)
9. Option to compile Moses as a dynamic library (thanks to Jean-Bapist Fouet).
10. Hierarchical re-ordering model (thanks to Christian Harmeyer, Sara Styme, Nadi, Marcello, Ankit Srivastava, Gabriele Antonio Musillo, Philip Williams, Barry Haddow).
11. Global Lexical re-ordering model (thanks to Philipp Koehn)
12. Experiment.perl scripts for automating the whole MT pipeline (thanks to Philipp Koehn)

## 2.5 Work in Progress

Refer to the website (<http://www.statmt.org/moses/?n=Moses.Releases>)

## 3

# Tutorials

### 3.1 Phrase-based Tutorial

This tutorial describes the workings of the phrase-based decoder in Moses, using a simple model downloadable from the Moses website.

#### 3.1.1 A Simple Translation Model

Let us begin with a look at the toy phrase-based translation model that is available for download at <http://www.statmt.org/moses/download/sample-models.tgz>. Unpack the tar ball and enter the directory `sample-models/phrase-model`.

The model consists of two files:

- `phrase-table` the phrase translation table, and
- `moses.ini` the configuration file for the decoder.

Let us look at the first line of the **phrase translation table** (file `phrase-table`):

```
der ||| the ||| 0.3 ||| |||
```

This entry means that the probability of translating the English word `the` from the German `der` is 0.3. Or in mathematical notation:  $p(\text{the}|\text{der})=0.3$ . Note that these translation probabilities are in the inverse order due to the noisy channel model.

The translation tables are the main knowledge source for the machine translation decoder. The decoder consults these tables to figure out how to translate input in one language into output in another language.

Being a phrase translation model, the translation tables do not only contain single word entries, but multi-word entries. These are called **phrases**, but this concept means nothing more than an arbitrary sequence of words, with no sophisticated linguistic motivation.

Here is an example for a phrase translation entry in `phrase-table`:

```
das ist ||| this is ||| 0.8 ||| |||
```

### 3.1.2 Running the Decoder

Without further ado, let us run the decoder (it needs to be run from the `sample-models` directory):

```
% echo 'das ist ein kleines haus' | moses -f phrase-model/moses.ini > out
Defined parameters (per moses.ini or switch):
config: phrase-model/moses.ini
input-factors: 0
lmodel-file: 8 0 3 lm/europarl.srlm.gz
mapping: T 0
n-best-list: nbest.txt 100
ttable-file: 0 0 0 1 phrase-model/phrase-table
ttable-limit: 10
weight-d: 1
weight-l: 1
weight-t: 1
weight-w: 0
Loading lexical distortion models...have 0 models
Start loading LanguageModel lm/europarl.srlm.gz : [0.000] seconds
Loading the LM will be faster if you build a binary file.
Reading lm/europarl.srlm.gz
----5---10---15---20---25---30---35---40---45---50---55---60---65---70---75---80---85---90---95--100
*****
The ARPA file is missing <unk>. Substituting log10 probability -100.000.
Finished loading LanguageModels : [2.000] seconds
Start loading PhraseTable phrase-model/phrase-table : [2.000] seconds
filePath: phrase-model/phrase-table
Finished loading phrase tables : [2.000] seconds
Start loading phrase table from phrase-model/phrase-table : [2.000] seconds
Reading phrase-model/phrase-table
----5---10---15---20---25---30---35---40---45---50---55---60---65---70---75---80---85---90---95--100
*****
Finished loading phrase tables : [2.000] seconds
IO from STDOUT/STDIN
Created input-output object : [2.000] seconds
Translating line 0 in thread id 0
Translating: das ist ein kleines haus

Collecting options took 0.000 seconds
Search took 0.000 seconds
BEST TRANSLATION: this is a small house [11111] [total=-28.923] <<0.000, -5.000, 0.000, -27.091, -1.833>>
Translation took 0.000 seconds
Finished translating

% cat out
this is a small house
```

Here, the toy model managed to translate the German input sentence `das ist ein kleines haus` into the English `this is a small house`, which is a correct translation.



The decoder is controlled by the configuration file `moses.ini`. The file used in the example above is displayed below.

```
#####
### MOSES CONFIG FILE ###
#####

# input factors
[input-factors]
0

# mapping steps, either (T) translation or (G) generation
[mapping]
T 0

[feature]
KENLM name=LM factor=0 order=3 num-features=1 path=lm/europarl.srilm.gz
Distortion
WordPenalty
UnknownWordPenalty
PhraseDictionaryMemory input-factor=0 output-factor=0 path=phrase-model/phrase-table num-features=1 table-limit=10

[weight]
WordPenalty0= 0
LM= 1
Distortion0= 1
PhraseDictionaryMemory0= 1

[n-best-list]
nbest.txt
100
```

We will take a look at all the parameters that are specified here (and then some) later. At this point, let us just note that the translation model files and the language model file are specified here. In this example, the file names are relative paths, but usually having full paths is better, so that the decoder does not have to be run from a specific directory.

We just ran the decoder on a single sentence provided on the command line. Usually we want to translate more than one sentence. In this case, the input sentences are stored in a file, one sentence per line. This file is piped into the decoder and the output is piped into some output file for further processing:

```
% moses -f phrase-model/moses.ini < phrase-model/in > out
```

### 3.1.3 Trace

How the decoder works is described in detail in the background (Section 6.1) section. But let us first develop an intuition by looking under the hood. There are two switches that force the decoder to reveal more about its inner workings: `-report-segmentation` and `-verbose`.

The trace option reveals which phrase translations were used in the best translation found by the decoder. Running the decoder with the segmentation trace switch (short `-t`) on the same example

```
echo 'das ist ein kleines haus' | moses -f phrase-model/moses.ini -t >out
```

gives us the extended output

```
% cat out
this is |0-1| a |2-2| small |3-3| house |4-4|
```

Each generated English phrase is now annotated with additional information:

- `this is` was generated from the German words 0-1, `das ist`,
- `a` was generated from the German word 2-2, `ein`,
- `small` was generated from the German word 3-3, `kleines`, and
- `house` was generated from the German word 4-4, `haus`.

Note that the German sentence does not have to be translated in sequence. Here an example, where the English output is reordered:

```
echo 'ein haus ist das' | moses -f phrase-model/moses.ini -t -weight-overwrite "Distortion0= 0"
```

The output of this command is:

```
this |3-3| is |2-2| a |0-0| house |1-1|
```

### 3.1.4 Verbose

Now for the next switch, `-verbose` (short `-v`), that displays additional run time information. The verbosity of the decoder output exists in three levels. The default is 1. Moving on to `-v 2` gives additional statistics for each translated sentences:

```
% echo 'das ist ein kleines haus' | moses -f phrase-model/moses.ini -v 2
[...]
TRANSLATING(1): das ist ein kleines haus
Total translation options: 12
Total translation options pruned: 0
```

A short summary on how many translations options were used for the translation of these sentences.

```
Stack sizes: 1, 10, 2, 0, 0, 0
Stack sizes: 1, 10, 27, 6, 0, 0
Stack sizes: 1, 10, 27, 47, 6, 0
Stack sizes: 1, 10, 27, 47, 24, 1
Stack sizes: 1, 10, 27, 47, 24, 3
Stack sizes: 1, 10, 27, 47, 24, 3
```

The stack sizes after each iteration of the stack decoder. An iteration is the processing of all hypotheses on one stack: After the first iteration (processing the initial empty hypothesis), 10 hypothesis that cover one German word are placed on stack 1, and 2 hypotheses that cover two foreign words are placed on stack 2. Note how this relates to the 12 translation options.

```
total hypotheses generated = 453
number recombined = 69
number pruned = 0
number discarded early = 272
```

During the beam search a large number of hypotheses are generated (453). Many are discarded early because they are deemed to be too bad (272), or pruned at some later stage (0), and some are recombined (69). The remainder survives on the stacks.

```
total source words = 5
words deleted = 0 ()
words inserted = 0 ()
```

Some additional information on word deletion and insertion, two advanced options that are not activated by default.

```
BEST TRANSLATION: this is a small house [11111] [total=-28.923] <<0.000, -5.000, 0.000, -27.091, -1.833
Sentence Decoding Time: : [4.000] seconds
```

And finally, the translated sentence, its coverage vector (all 5 bits for the 5 German input words are set), its overall log-probability score, and the breakdown of the score into language model, reordering model, word penalty and translation model components.

Also, the sentence decoding time is given.

The most verbose output `-v 3` provides even more information. In fact, it is so much, that we could not possibly fit it in this tutorial. Run the following command and enjoy:

```
% echo 'das ist ein kleines haus' | moses -f phrase-model/moses.ini -v 3
```

Let us look together at some highlights. The overall translation score is made up from several components. The decoder reports these components, in our case:

```
The score component vector looks like this:
0 distortion score
1 word penalty
2 unknown word penalty
3 3-gram LM score, factor-type=0, file=lm/europarl.srilm.gz
4 Translation score, file=phrase-table
```

Before decoding, the phrase translation table is consulted for possible phrase translations. For some phrases, we find entries, for others we find nothing. Here an excerpt:

```
[das ; 0-0]
the , pC=-0.916, c=-5.789
this , pC=-2.303, c=-8.002
it , pC=-2.303, c=-8.076

[das ist ; 0-1]
it is , pC=-1.609, c=-10.207
this is , pC=-0.223, c=-10.291

[ist ; 1-1]
is , pC=0.000, c=-4.922
's , pC=0.000, c=-6.116
```

The pair of numbers next to a phrase is the coverage, `pC` denotes the log of the phrase translation probability, after `c` the future cost estimate for the phrase is given.

Future cost is an estimate of how hard it is to translate different parts of the sentence. After looking up phrase translation probabilities, future costs are computed for all contiguous spans over the sentence:

```

future cost from 0 to 0 is -5.789
future cost from 0 to 1 is -10.207
future cost from 0 to 2 is -15.722
future cost from 0 to 3 is -25.443
future cost from 0 to 4 is -34.709
future cost from 1 to 1 is -4.922
future cost from 1 to 2 is -10.437
future cost from 1 to 3 is -20.158
future cost from 1 to 4 is -29.425
future cost from 2 to 2 is -5.515
future cost from 2 to 3 is -15.236
future cost from 2 to 4 is -24.502
future cost from 3 to 3 is -9.721
future cost from 3 to 4 is -18.987
future cost from 4 to 4 is -9.266

```

Some parts of the sentence are easier to translate than others. For instance the estimate for translating the first two words (0-1: *das ist*) is deemed to be cheaper (-10.207) than the last two (3-4: *kleines haus*, -18.987). Again, the negative numbers are log-probabilities.

After all this preparation, we start to create partial translations by translating a phrase at a time. The first hypothesis is generated by translating the first German word as the:

```

creating hypothesis 1 from 0 ( <s> )
base score 0.000
covering 0-0: das
translated as: the
score -2.951 + future cost -29.425 = -32.375
unweighted feature scores: <<0.000, -1.000, 0.000, -2.034, -0.916>>
added hyp to stack, best on stack, now size 1

```

Here, starting with the empty initial hypothesis 0, a new hypothesis (id=1) is created. Starting from zero cost (base score), translating the phrase *das* into *the* carries translation cost (-0.916), distortion or reordering cost (0), language model cost (-2.034), and word penalty (-1). Recall that the score component information is printed out earlier, so we are able to interpret the vector.

Overall, a weighted log-probability cost of -2.951 is accumulated. Together with the future cost estimate for the remaining part of the sentence (-29.425), this hypothesis is assigned a score of -32.375.

And so it continues, for a total of 453 created hypothesis. At the end, the best scoring final hypothesis is found and the hypothesis graph traversed backwards to retrieve the best translation:

```
Best path: 417 <= 285 <= 163 <= 5 <= 0
```

Confused enough yet? Before we get caught too much in the intricate details of the inner workings of the decoder, let us return to actually using it. Much of what has just been said will become much clearer after reading the background (Section 6.1) information.

### 3.1.5 Tuning for Quality

The key to good translation performance is having a good phrase translation table. But some tuning can be done with the decoder. The most important is the tuning of the model parameters.

The probability cost that is assigned to a translation is a product of probability costs of four models:

- phrase translation table,
- language model,
- reordering model, and
- word penalty.

Each of these models contributes information over one aspect of the characteristics of a good translation:

- The **phrase translation** table ensures that the English phrases and the German phrases are good translations of each other.
- The **language model** ensures that the output is fluent English.
- The **distortion model** allows for reordering of the input sentence, but at a cost: The more reordering, the more expensive is the translation.
- The **word penalty** ensures that the translations do not get too long or too short.

Each of the components can be given a weight that sets its importance. Mathematically, the cost of translation is:

$$p(e|f) = \phi(f|e)^{\text{weight}_\phi} \times \text{LM}^{\text{weight}_{\text{LM}}} \times D(e, f)^{\text{weight}_d} \times W(e)^{\text{weight}_w} \quad (3.1)$$

The probability  $p(e|f)$  of the English translation  $e$  given the foreign input  $f$  is broken up into four models, phrase translation  $\phi(f|e)$ , language model  $\text{LM}(e)$ , distortion model  $D(e, f)$ , and word penalty  $W(e) = \exp(\text{length}(e))$ . Each of the four models is weighted by a weight.

The weighting is provided to the decoder with the four parameters `weight-t`, `weight-l`, `weight-d`, and `weight-w`. The default setting for these weights is 1, 1, 1, and 0. These are also the values in the configuration file `moses.ini`.

Setting these weights to the right values can improve translation quality. We already sneaked in one example above. When translating the German sentence `ein haus ist das`, we set the distortion weight to 0 to get the right translation:

```
% echo 'ein haus ist das' | moses -f phrase-model/moses.ini -d 0
this is a house
```

With the default weights, the translation comes out wrong:

```
% echo 'ein haus ist das' | moses -f phrase-model/moses.ini
a house is the
```

What is the right weight setting depends on the corpus and the language pair. Usually, a held out development set is used to optimize the parameter settings. The simplest method here is to try out with a large number of possible settings, and pick what works best. Good values for the weights for phrase translation table (`weight-t`, short `tm`), language model (`weight-l`, short `lm`), and reordering model (`weight-d`, short `d`) are 0.1-1, good values for the word penalty (`weight-w`, short `w`) are -3-3. Negative values for the word penalty favor longer output, positive values favor shorter output.

### 3.1.6 Tuning for Speed

Let us now look at some additional parameters that help to speed up the decoder. Unfortunately higher speed usually comes at cost of translation quality. The speed-ups are achieved by limiting the search space of the decoder. By cutting out part of the search space, we may not be able to find the best translation anymore.

#### Translation Table Size

One strategy to limit the search space is by reducing the number of translation options used for each input phrase, i.e. the number of phrase translation table entries that are retrieved. While in the toy example, the translation tables are very small, these can have thousands of entries per phrase in a realistic scenario. If the phrase translation table is learned from real data, it contains a lot of noise. So, we are really interested only in the most probable ones and would like to eliminate the others.

There are two ways to limit the translation table size: by a fixed limit on how many translation options are retrieved for each input phrase, and by a probability threshold, that specifies that the phrase translation probability has to be above some value.

Compare the statistics and the translation output for our toy model, when no translation table limit is used

```
% echo 'das ist ein kleines haus' | moses -f phrase-model/moses.ini -ttable-limit 0 -v 2
[...]
Total translation options: 12
[...]
total hypotheses generated = 453
number recombined = 69
number pruned = 0
number discarded early = 272
[...]
BEST TRANSLATION: this is a small house [11111] [total=-28.923]
```

with the statistics and translation output, when a limit of 1 is used

```
% echo 'das ist ein kleines haus' | moses -f phrase-model/moses.ini -ttable-limit 1 -v 2
[...]
Total translation options: 6
[...]
total hypotheses generated = 127
number recombined = 8
number pruned = 0
number discarded early = 61
[...]
BEST TRANSLATION: it is a small house [11111] [total=-30.327]
```

Reducing the number of translation options to only one per phrase, had a number of effects: (1) Overall only 6 translation options instead of 12 translation options were collected. (2) The number of generated hypothesis fell to 127 from 442, and no hypotheses were pruned out. (3) The translation changed, and the output now has lower log-probability: -30.327 vs. -28.923.

### Hypothesis Stack Size (Beam)

A different way to reduce the search is to reduce the size of hypothesis stacks. For each number of foreign words translated, the decoder keeps a stack of the best (partial) translations. By reducing this stack size the search will be quicker, since less hypotheses are kept at each stage, and therefore less hypotheses are generated. This is explained in more detail on the Background (Section 6.1) page.

From a user perspective, search speed is linear to the maximum stack size. Compare the following system runs with stack size 1000, 100 (the default), 10, and 1:



```
% echo 'das ist ein kleines haus' | moses -f phrase-model/moses.ini -v 2 -s 1000
[...]
total hypotheses generated = 453
number recombined = 69
number pruned = 0
number discarded early = 272
[...]
BEST TRANSLATION: this is a small house [11111] [total=-28.923]

% echo 'das ist ein kleines haus' | moses -f phrase-model/moses.ini -v 2 -s 100
[...]
total hypotheses generated = 453
number recombined = 69
number pruned = 0
number discarded early = 272
[...]
BEST TRANSLATION: this is a small house [11111] [total=-28.923]

% echo 'das ist ein kleines haus' | moses -f phrase-model/moses.ini -v 2 -s 10
[...]
total hypotheses generated = 208
number recombined = 23
number pruned = 42
number discarded early = 103
[...]
BEST TRANSLATION: this is a small house [11111] [total=-28.923]

% echo 'das ist ein kleines haus' | moses -f phrase-model/moses.ini -v 2 -s 1
[...]
total hypotheses generated = 29
number recombined = 0
number pruned = 4
number discarded early = 19
[...]
BEST TRANSLATION: this is a little house [11111] [total=-30.991]
```

Note that the number of hypothesis entered on stacks is getting smaller with the stack size: 453, 453, 208, and 29.

As we have previously described with translation table pruning, we may also want to use the relative scores of hypothesis for pruning instead of a fixed limit. The two strategies are also called histogram pruning and threshold pruning.

Here some experiments to show the effects of different stack size limits and beam size limits.

```
% echo 'das ist ein kleines haus' | moses -f phrase-model/moses.ini -v 2 -s 100 -b 0
[...]
```

```

total hypotheses generated = 1073
number recombined = 720
number pruned = 73
number discarded early = 0
[...]

% echo 'das ist ein kleines haus' | moses -f phrase-model/moses.ini -v 2 -s 1000 -b 0
[...]
total hypotheses generated = 1352
number recombined = 985
number pruned = 0
number discarded early = 0
[...]

% echo 'das ist ein kleines haus' | moses -f phrase-model/moses.ini -v 2 -s 1000 -b 0.1
[...]
total hypotheses generated = 45
number recombined = 3
number pruned = 0
number discarded early = 32
[...]

```

In the second example no pruning takes place, which means an exhaustive search is performed. With small stack sizes or small thresholds we risk search errors, meaning the generation of translations that score worse than the best translation according to the model.

In this toy example, a worse translation is only generated with a stack size of 1. Again, by worse translation, we mean worse scoring according to our model (-30.991 vs. -28.923). If it is actually a worse translation in terms of translation quality, is another question. However, the task of the decoder is to find the best scoring translation. If worse scoring translations are of better quality, then this is a problem of the model, and should be resolved by better modeling.

### 3.1.7 Limit on Distortion (Reordering)

The basic reordering model implemented in the decoder is fairly weak. Reordering cost is measured by the number of words skipped when foreign phrases are picked out of order.

Total reordering cost is computed by  $D(e,f) = -\sum_i (d_i)$  where  $d$  for each phrase  $i$  is defined as  $d = \text{abs}(\text{last word position of previously translated phrase} + 1 - \text{first word position of newly translated phrase})$ .

This is illustrated by the following graph:

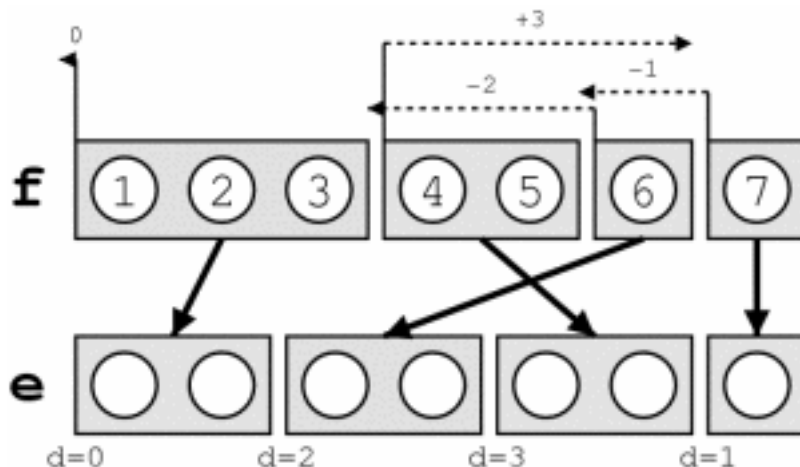

This reordering model is suitable for local reorderings: they are discouraged, but may occur with sufficient support from the language model. But large-scale reorderings are often arbitrary and effect translation performance negatively.

By limiting reordering, we can not only speed up the decoder, often translation performance is increased. Reordering can be limited to a maximum number of words skipped (maximum  $d$ ) with the switch `-distortion-limit`, or short `-dl`.

Setting this parameter to 0 means monotone translation (no reordering). If you want to allow unlimited reordering, use the value -1.

*Subsection last modified on June 21, 2014, at 09:16 PM*

## 3.2 Tutorial for Using Factored Models

**Note:** There may be some discrepancies between this description and the actual workings of the training script.

- Train an unfactored model (Section 3.2.1)
- Train a model with POS tags (Section 3.2.2)
- Train a model with generation and translation steps (Section 3.2.3)
- Train a morphological analysis and generation model (Section 3.2.4)
- Train a model with multiple decoding paths (Section 3.2.5)

To work through this tutorial, you first need to have the data in place. The instructions also assume that you have the training script and the decoder in you executable path.

You can obtain the data as follows:

- `wget http://www.statmt.org/moses/download/factored-corpus.tgz`
- `tar xzf factored-corpus.tgz`

For more information on the training script, check the documentation, which is linked to on the right navigation column under "Training".

### 3.2.1 Train an unfactored model

The corpus package contains language models and parallel corpora with POS and lemma factors. Before playing with factored models, let us start with training a traditional phrase-based model:

```
% train-model.perl \
--root-dir unfactored \
--corpus factored-corpus/proj-syndicate \
--f de --e en \
--lm 0:3:factored-corpus/surface.lm \
--external-bin-dir ../tools \
--input-factor-max 4
```

This creates a phrase-based model in the directory `unfactored/model` in about 20 minutes (on a 2.8GHZ machine). For a quicker training run that only takes a few minutes (with much worse results) use the just the first 1000 sentence pairs of the corpus, contained in `factored-corpus/proj-syndicate`

```
% train-model.perl \
--root-dir unfactored \
--corpus factored-corpus/proj-syndicate.1000 \
--f de --e en \
--lm 0:3:factored-corpus/surface.lm \
--external-bin-dir ../tools \
--input-factor-max 4
```

This creates a typical phrase-based model, as specified in the created configuration file `moses.ini`. Here the part of the file that points to the phrase table:

```
[feature]
PhraseDictionaryMemory ... path=../phrase-table.gz ...
```

You can take a look at the generated phrase table, which starts as usual with rubbish but then occasionally contains some nice entries. The scores ensure that during decoding the good entries are preferred.

```
! ||| ! ||| 1 1 1 1 2.718
" ( ||| " ( ||| 1 0.856401 1 0.779352 2.718
" ) , ein neuer film ||| " a new film ||| 1 0.0038467 1 0.128157 2.718
" ) , ein neuer film über ||| " a new film about ||| 1 0.000831718 1 0.0170876 2.71
[...]
frage ||| issue ||| 0.25 0.285714 0.25 0.166667 2.718
frage ||| question ||| 0.75 0.555556 0.75 0.416667 2.718
```

### 3.2.2 Train a model with POS tags

Take a look at the training data. Each word is not only represented by its surface form (as you would expect in raw text), but also with additional factors.

```
% tail -n 1 factored-corpus/proj-syndicate.??
==> factored-corpus/proj-syndicate.de <==
korruption|korruption|nn|nn.fem.cas.sg floriert|florieren|vvfin|vvfin .|. |per|per

==> factored-corpus/proj-syndicate.en <==
corruption|corruption|nn flourishes|flourish|nns .|. |.
```

The German factors are

- surface form,
- lemma,
- part of speech, and
- part of speech with additional morphological information.

The English factors are

- surface form,
- lemma, and
- part of speech.

Let us start simple and build a translation model that adds only the target part-of-speech factor on the output side:

```
% train-model.perl \
--root-dir pos \
--corpus factored-corpus/proj-syndicate.1000 \
--f de --e en \
--lm 0:3:factored-corpus/surface.lm \
--lm 2:3:factored-corpus/pos.lm \
--translation-factors 0-0,2 \
--external-bin-dir ../tools
```

Here, we specify with `--translation-factors 0-0,2` that the input factor for the translation table is the (0) surface form, and the output factor is (0) surface form and (2) part of speech.

```
[feature]
PhraseDictionaryMemory ... input-factor=0 output-factor=0,2
```

The resulting phrase table looks very similar, but now also contains part-of-speech tags on the English side:

```
! ||| !|. ||| 1 1 1 1 2.718
" ( ||| "|" (| ( ||| 1 0.856401 1 0.779352 2.718
" ) , ein neuer film ||| "|" a|dt new|jj film|nn ||| 1 0.00403191 1 0.128157 2.718
" ) , ein neuer film über ||| "|" a|dt new|jj film|nn about|in ||| 1 0.000871765 1 0.0170876 2.718
[...]
frage ||| issue|nn ||| 0.25 0.285714 0.25 0.166667 2.718
frage ||| question|nn ||| 0.75 0.625 0.75 0.416667 2.718
```

We also specified two language models. Besides the regular language model based on surface forms, we have a second language model that is trained on POS tags. In the configuration file this is indicated by two lines in the LM section:

```
[feature]
KENLM name=LM0 ...
KENLM name=LM1 ...
```

Also, two language model weights are specified:

```
[weight]
LM0= 0.5
LM1= 0.5
```

The part-of-speech language model includes preferences such as that determiner-adjective is likely followed by a noun, and less likely by a determiner:

```
-0.192859      dt jj nn
-2.952967      dt jj dt
```

This model can be used just like normal phrase based models:

```
% echo 'putin beschreibt menschen .' > in
% moses -f pos/model/moses.ini < in
[...]
BEST TRANSLATION: putin|nnp describes|vbz people|nns .|. [1111] [total=-6.049]
<<0.000, -4.000, 0.000, -29.403, -11.731, -0.589, -1.303, -0.379, -0.556, 4.000>>
[...]
```

During the decoding process, not only words (putin), but also part-of-speech are generated (nnp).

Let's take a look what happens, if we input a German sentence that starts with the object:

```
% echo 'menschen beschreibt putin .' > in
% moses -f pos/model/moses.ini < in
BEST TRANSLATION: people|nns describes|vbz putin|nnp .|. [1111] [total=-8.030]
<<0.000, -4.000, 0.000, -31.289, -17.770, -0.589, -1.303, -0.379, -0.556, 4.000>>
```

Now, this is not a very good translation. The model's aversion to do reordering trumps our ability to come up with a good translation. If we downweight the reordering model, we get a better translation:

```
% moses -f pos/model/moses.ini < in -d 0.2
BEST TRANSLATION: putin|nnp describes|vbz people|nns .|. [1111] [total=-7.649]
<<-8.000, -4.000, 0.000, -29.403, -11.731, -0.589, -1.303, -0.379, -0.556, 4.000>>
```

Note that this better translation is mostly driven by the part-of-speech language model, which prefers the sequence nnp vbz nns . (-11.731) over the sequence nns vbz nnp . (-17.770). The surface form language model only shows a slight preference (-29.403 vs. -31.289). This is because these words have not been seen next to each other before, so the language model has very little to work with. The part-of-speech language model is aware of the count of the nouns involved and prefers a singular noun before a singular verb (nnp vbz) over a plural noun before a singular verb (nns vbz).

To drive this point home, the unfactored model is not able to find the right translation, even with downweighted reordering model:

```
% moses -f unfactored/model/moses.ini < in -d 0.2
people describes putin . [1111] [total=-11.410]
<<0.000, -4.000, 0.000, -31.289, -0.589, -1.303, -0.379, -0.556, 4.000>>
```

### 3.2.3 Train a model with generation and translation steps

Let us now train a slightly different factored model with the same factors. Instead of mapping from the German input surface form directly to the English output surface form and part of speech, we now break this up into two mapping steps, one translation step that maps surface forms to surface forms, and a second step that generates the part of speech from the surface form on the output side:

```
% train-model.perl \
--root-dir pos-decomposed \
--corpus factored-corpus/proj-syndicate.1000 \
--f de --e en \
--lm 0:3:factored-corpus/surface.lm \
--lm 2:3:factored-corpus/pos.lm \
--translation-factors 0-0 \
--generation-factors 0-2 \
--decoding-steps t0,g0 \
--external-bin-dir ../tools
```

Now, the translation step is specified only between surface forms (`--translation-factors 0-0`) and a generation step is specified (`--generation-factors 0-2`), mapping (0) surface form to (2) part of speech. We also need to specify in which order the mapping steps are applied (`--decoding-steps t0,g0`).

Besides the phrase table that has the same format as the unfactored phrase table, we now also have a generation table. It is referenced in the configuration file:

```
[feature]
Generation ... input-factor=0 output-factor=2

[weight]
GenerationModel0= 0.3 0
```

Let us take a look at the generation table:

```
% more pos-decomposed/model/generation.0-2
nigerian nnp 1.0000000 0.0008163
proven vbn 1.0000000 0.0021142
issue nn 1.0000000 0.0021591
[...]
control vb 0.1666667 0.0014451
control mn 0.8333333 0.0017992
[...]
```



The beginning is not very interesting. As most words, *nigerian*, *proven*, and *issue* occur only with one part of speech, e.g.,  $p(\text{np}|nigerian) = 1.0000000$ . Some words, however, such as *control* occur with multiple part of speech, such as base form verb (*vb*) and single noun (*nn*).

The table also contains the reverse translation probability  $p(nigerian|np) = 0.0008163$ . In our example, this may not be a very useful feature. It basically hurts open class words, especially unusual ones. If we do not want this feature, we can also train the generation model as single-featured by the switch `--generation-type single`.

### 3.2.4 Train a morphological analysis and generation model

Translating surface forms seems to be a somewhat questionable pursuit. It does not seem to make much sense to treat different word forms of the same lemma, such as *mensch* and *menschen* differently. In the worst case, we will have seen only one of the word forms, so we are not able to translate the other. This is what in fact happens in this example:

```
% echo 'ein mensch beschreibt putin .' > in
% moses.1430.srilm -f unfactored/model/moses.ini < in
a mensch|UNK|UNK|UNK describes putin . [11111] [total=-158.818]
<<0.000, -5.000, -100.000, -127.565, -1.350, -1.871, -0.301, -0.652, 4.000>>
```

Factored translation models allow us to create models that do morphological analysis and decomposition during the translation process. Let us now train such a model:

```
% train-model.perl \
--root-dir morphgen \
--corpus factored-corpus/proj-syndicate.1000 \
--f de --e en \
--lm 0:3:factored-corpus/surface.lm \
--lm 2:3:factored-corpus/pos.lm \
--translation-factors 1-1+3-2 \
--generation-factors 1-2+1,2-0 \
--decoding-steps t0,g0,t1,g1 \
--external-bin-dir ../tools
```

We have a total of four mapping steps:

- a translation step that maps lemmas (1-1),
- a generation step that sets possible part-of-speech tags for a lemma (1-2),
- a translation step that maps morphological information to part-of-speech tags (3-2), and
- a generation step that maps part-of-speech tag and lemma to a surface form (1, 2-0).

This enables us now to translate the sentence above:

```
% echo 'ein|ein|art|art.indef.z mensch|mensch|nn|nn.masc.nom.sg \
beschreibe|beschreiben|vvfin|vvfin putin|putin|nn|nn.masc.cas.sg \
.|.|per|per' > in
% moses -f morphgen/model/moses.ini < in
BEST TRANSLATION: a|a|dt individual|individual|nn describes|describe|vbz \
putin|putin|nnp .|.|. [11111] [total=-17.269]
<<0.000, -5.000, 0.000, -38.631, -13.357, -2.773, -21.024, 0.000, -1.386, \
-1.796, -4.341, -3.189, -4.630, 4.999, -13.478, -14.079, -4.911, -5.774, 4.999>>
```

Note that this is only possible, because we have seen an appropriate word form in the output language. The word `individual` occurs as single noun in the parallel corpus, as translation of `einzelnen`. To overcome this limitation, we may train generation models on large monolingual corpora, where we expect to see all possible word forms.

### 3.2.5 Train a model with multiple decoding paths

Decomposing translation into a process of morphological analysis and generation will make our translation model more robust. However, if we have seen a phrase of surface forms before, it may be better to take advantage of such rich evidence.

The above model poorly translates sentences, as it does use the source surface form at all, relying on translating the properties of the surface forms.

In practice, we fair better when we allow both ways to translate in parallel. Such a model is trained by the introduction of decoding paths. In our example, one decoding path is the morphological analysis and generation as above, the other path the direct mapping of surface forms to surface forms (and part-of-speech tags, since we are using a part-of-speech tag language model):

```
% train-model.perl \
--corpus factored-corpus/proj-syndicate.1000 \
--root-dir morphgen-backoff \
--f de --e en \
--lm 0:3:factored-corpus/surface.lm \
--lm 2:3:factored-corpus/pos.lm \
--translation-factors 1-1+3-2+0-0,2 \
--generation-factors 1-2+1,2-0 \
--decoding-steps t0,g0,t1,g1:t2 \
--external-bin-dir ../tools
```

This command is almost identical to the previous training run, except for the additional translation table `0-0,2` and its inclusion as a different decoding path `:t2`.

A strategy for translating surface forms which have not been seen in the training corpus is to translate its lemma instead. This is especially useful for translation from morphologically rich languages to simpler languages, such as German to English translation.

```
% train-model.perl \
--corpus factored-corpus/proj-syndicate.1000 \
--root-dir lemma-backoff \
--f de --e en \
--lm 0:3:factored-corpus/surface.lm \
--lm 2:3:factored-corpus/pos.lm \
--translation-factors 0-0,2+1-0,2 \
--decoding-steps t0:t1 \
--external-bin-dir ../tools
```

*Subsection last modified on May 29, 2016, at 11:02 PM*

### 3.3 Syntax Tutorial

24 *And the people murmured against Moses, saying, What shall we drink?*

25 *And he cried unto the Lord; and the Lord showed him a **tree**, which when he had cast into the waters, the waters were made sweet.*

*Exodus 15, 24-25*

Moses supports models that have become known as *hierarchical phrase-based models* and *syntax-based models*. These models use a grammar consisting of SCFG (Synchronous Context-Free Grammar) rules. In the following, we refer to these models as **tree-based models**.

#### 3.3.1 Tree-Based Models

Traditional phrase-based models have as atomic translation step the mapping of an input phrase to an output phrase. Tree-based models operate on so-called grammar rules, which include variables in the mapping rules:

```
ne X1 pas -> not X1 (French-English)
ate X1 -> habe X1 gegessen (English-German)
X1 of the X2 -> le X2 X1 (English-French)
```

The variables in these grammar rules are called non-terminals, since their occurrence indicates that the process has not yet terminated to produce the final words (the *terminals*). Besides a

generic non-terminal  $X$ , linguistically motivated non-terminals such as NP (noun phrase) or VP (verb phrase) may be used as well in a grammar (or translation rule set).

We call these models tree-based, because during the translation a data structure is created that is called a tree. To fully make this point, consider the following input and translation rules:

```
Input: Das Tor geht schnell auf
Rules: Das Tor -> The door
schnell -> quickly
geht X1 auf -> opens X1
X1 X2 -> X1 X2
```

When applying these rules in the given order, we produce the translation *The door opens quickly* in the following fashion:

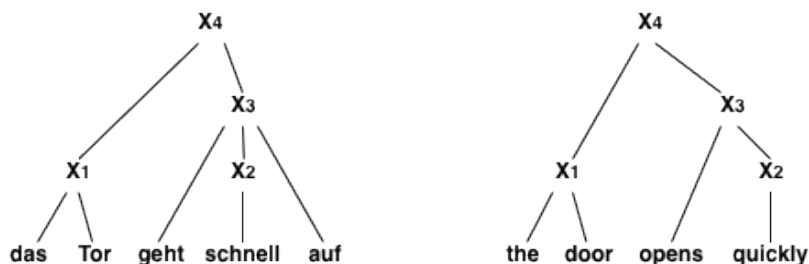

First the simple phrase mappings (1) Das Tor to The door and (2) schnell to quickly are carried out. This allows for the application of the more complex rule (3) geht  $X_1$  auf to opens  $X_1$ . Note that at this point, the non-terminal  $X$ , which covers the input span over schnell is replaced by a known translation quickly. Finally, the glue rule (4)  $X_1 X_2$  to  $X_1 X_2$  combines the two fragments into a complete sentence.

Here is how the spans over the input words are getting filled in:

```
|4 ---- The door opens quickly ---- |
|           |3 --- opens quickly --- | | | |
|1 The door |           |2 quickly |           |
| Das | Tor | geht | schnell | auf |
```

Formally, such context-free grammars are more constraint than the formalism for phrase-based models. In practice, however, phrase-based models use a reordering limit, which leads to linear decoding time. For tree-based models, decoding is not linear with respect to sentence length, unless reordering limits are used.

Current research in tree-based models has the expectation to build translation models that more closely model the underlying linguistic structure of language, and its essential element: recursion. This is an active field of research.

### A Word on Terminology

You may have read in the literature about hierarchical phrase-based, string-to-tree, tree-to-string, tree-to-tree, target-syntactified, syntax-augmented, syntax-directed, syntax-based, grammar-based, etc., models in statistical machine translation. What do the tree-based models support? All of the above.

The avalanche of terminology stems partly from the need of researchers to carve out their own niche, partly from the fact that work in this area has not yet fully settled on a agreed framework, but also from a fundamental difference. As we already pointed out, the motivation for tree-based models are linguistic theories and their syntax trees. So, when we build a data structure called a *tree* (as Computer Scientist call it), do we mean that we build a linguistic syntax *tree* (as Linguists call it)?

Not always, and hence the confusion. In all our examples above we used a single non-terminal  $X$ , so not many will claim the the result is a proper linguistic syntax with its noun phrases NP, verb phrases VP, and so on. To distinguish models that use proper linguistic syntax on the input side, on the output side, on both, or on neither all this terminology has been invented.

Let's decipher common terms found in the literature:

- hierarchical phrase-based: no linguistic syntax,
- string-to-tree: linguistic syntax only in output language,
- tree-to-string: linguistic syntax only in input language,
- tree-to-tree: linguistic syntax in both languages,
- target-syntactified: linguistic syntax only in output language,
- syntax-augmented: linguistic syntax only in output language,
- syntax-directed: linguistic syntax only in input language,
- syntax-based: unclear, we use it for models that have any linguistic syntax, and
- grammar-based: wait, what?

In this tutorial, we refer to un-annotated trees as **trees**, and to trees with syntactic annotation as **syntax**. So a so-called string-to-tree model is here called a target-syntax model.

### Chart Decoding

Phrase-Based decoding generates a sentence from left to right, by adding phrases to the end of a partial translation. Tree-based decoding builds a chart, which consists of partial translation for all possible spans over the input sentence.

Currently Moses implements a CKY+ algorithm for arbitrary number of non-terminals per rule and an arbitrary number of types of non-terminals in the grammar.

#### 3.3.2 Decoding

We assume that you have already installed the chart decoder, as described in the Get Started<sup>1</sup> section.

You can find an example model for the decoder from the Moses web site<sup>2</sup>. Unpack the tar ball and enter the directory `sample-models`:

<sup>1</sup><http://www.statmt.org/moses/?n=Development.GetStarted#chart>

<sup>2</sup><http://www.statmt.org/moses/download/sample-models.tgz>

```
% wget http://www.statmt.org/moses/download/sample-models.tgz
% tar xzf sample-models.tgz
% cd sample-models/string-to-tree
```

The decoder is called just as for phrase models:

```
% echo 'das ist ein haus' | moses_chart -f moses.ini > out
% cat out
this is a house
```

What happened here?

### Trace

Using the option `-T` we can some insight how the translation was assembled:

```
41 X TOP -> <s> S </s> (1,1) [0..5] -3.593 <<0.000, -2.606, -9.711, 2.526>> 20
20 X S -> NP V NP (0,0) (1,1) (2,2) [1..4] -1.988 <<0.000, -1.737, -6.501, 2.526>> 3 5 11
3 X NP -> this [1..1] 0.486 <<0.000, -0.434, -1.330, 2.303>>
5 X V -> is [2..2] -1.267 <<0.000, -0.434, -2.533, 0.000>>
11 X NP -> DT NN (0,0) (1,1) [3..4] -2.698 <<0.000, -0.869, -5.396, 0.000>> 7 9
7 X DT -> a [3..3] -1.012 <<0.000, -0.434, -2.024, 0.000>>
9 X NN -> house [4..4] -2.887 <<0.000, -0.434, -5.774, 0.000>>
```

Each line represents a hypothesis that is part of the derivation of the best translation. The pieces of information in each line (with the first line as example) are:

- the hypothesis number, a sequential identifier (41),
- the input non-terminal (X),
- the output non-terminal (S),
- the rule used to generate this hypothesis (TOP -> <s> S </s>),
- alignment information between input and output non-terminals in the rule ((1,1)),
- the span covered by the hypothesis, as defined by input word positions ([0..5]),
- the score of the hypothesis (3.593),
- its component scores (<<...>>):
  - unknown word penalty (0.000),
  - word penalty (-2.606),
  - language model score (-9.711),
  - rule application probability (2.526), and
- prior hypotheses, i.e. the children nodes in the tree, that this hypothesis is built on (20).

As you can see, the model used here is a target-syntax model. It uses linguistic syntactic annotation on the target side, but on the input side everything is labeled X.

## Rule Table

If we look at the `string-to-tree` directory, we find two files: the configuration file `moses.ini` which points to the language model (in `lm/europarl.srlm.gz`), and the rule table file `rule-table`.

The configuration file `moses.ini` has a fairly familiar format. It is mostly identical to the configuration file for phrase-based models. We will describe further below in detail the new parameters of the chart decoder.

The rule table `rule-table` is an extension of the Pharaoh/Moses phrase-table, so it will be familiar to anybody who has used it before. Here are some lines as example:

```
gibt [X] ||| gives [ADJ] ||| 1.0 ||| ||| 3 5
es gibt [X] ||| there is [ADJ] ||| 1.0 ||| ||| 2 3
[X][DT] [X][NN] [X] ||| [X][DT] [X][NN] [NP] ||| 1.0 ||| 0-0 1-1 ||| 2 4
[X][DT] [X][ADJ] [X][NN] [X] ||| [X][DT] [X][ADJ] [X][NN] [NP] ||| 1.0 ||| 0-0 1-1 2-2 ||| 5 6
[X][V] [X][NP] [X] ||| [X][V] [X][NP] [VP] ||| 1.0 ||| 0-0 1-1 ||| 4 3
```

Each line in the rule table describes one translation rule. It consists of five components separated by three bars:

1. the source string and source left-hand-side,
2. the target string and target left-hand-side,
3. score(s): here only one, but typically multiple scores are used,
4. the alignment between non-terminals (using word positions starting with 0, as source-target), and
5. frequency counts of source & target phrase (for debugging purposes; not used during decoding).

The format is slightly different from the Hiero format. For example, the Hiero rule

```
[X] ||| [X,1] trace ' ||| [X,1] &#52628;&#51201; ' \
||| 0.727273 0.444625 1 0.172348 2.718
```

is formatted as

```
[X][X] trace ' [X] ||| [X][X] &#52628;&#51201; ' [X] \
||| 0.727273 0.444625 1 0.172348 2.718 ||| 0-0 ||| 2 3
```

A syntax rule in a string-to-tree grammar:

```
[NP] ||| all [NN,1] ||| &#47784;&#46304; [NN,1] \
||| 0.869565 0.627907 0.645161 0.243243 2.718
```

is formatted as

```
all [X][NN] [X] ||| &#47784;&#46304; [X][NN] [NP] \
||| 0.869565 0.627907 0.645161 0.243243 2.718 ||| 1-1 ||| 23 31
```

The format can also represent a tree-to-string rule, which has no Hiero equivalent:

```
all [NN][X] [NP] ||| &#47784;&#46304; [NN][X] [X] \
||| 0.869565 0.627907 0.645161 0.243243 2.718 ||| 1-1 ||| 23 31
```

Usually, you will also need these 'glue' rules:

```
<s> [X][S] </s> [X] ||| <s> [X][S] </s> [TOP] ||| 1.0 ||| 1-1
<s> [X][NP] </s> [X] ||| <s> [X][NP] </s> [TOP] ||| 1.0 ||| 1-1
<s> [X] ||| <s> [S] ||| 1 |||
[X][S] </s> [X] ||| [X][S] </s> [S] ||| 1 ||| 0-0
[X][S] [X][X] [X] ||| [X][S] [X][X] [S] ||| 2.718 ||| 0-0 1-1
```

Finally, this rather technical rule applies only to spans that cover everything except the sentence boundary markers <s> and </s>. It completes a translation with of a sentence span (S).

### More Example

The second rule in the table, that we just glanced at, allows something quite interesting: the translation of a non-contiguous phrase: macht X auf.

Let us try this with the decoder on an example sentence:



```
% echo 'er macht das tor auf' | moses_chart -f moses.ini -T trace-file ; cat trace-file
[...]
14 X TOP -> <s> S </s> (1,1) [0..6] -7.833 <<0.000, -2.606, -17.163, 1.496>> 13
13 X S -> NP VP (0,0) (1,1) [1..5] -6.367 <<0.000, -1.737, -14.229, 1.496>> 2 11
2 X NP -> he [1..1] -1.064 <<0.000, -0.434, -2.484, 0.357>>
11 X VP -> opens NP (1,1) [2..5] -5.627 <<0.000, -1.303, -12.394, 1.139>> 10
10 X NP -> DT NN (0,0) (1,1) [3..4] -3.154 <<0.000, -0.869, -7.224, 0.916>> 6 7
6 X DT -> the [3..3] 0.016 <<0.000, -0.434, -0.884, 0.916>>
7 X NN -> gate [4..4] -3.588 <<0.000, -0.434, -7.176, 0.000>>
he opens the gate
```

You see the creation application of the rule in the creation of hypothesis 11. It generates opens NP to cover the input span [2..5] by using hypothesis 10, which covers the span [3..4].

Note that this rule allows us to do something that is not possible with a simple phrase-based model. Phrase-based models in Moses require that all phrases are contiguous, they can not have gaps.

The final example illustrates how reordering works in a tree-based model:

```
% echo 'ein haus ist das' | moses_chart -f moses.ini -T trace-file ; cat trace-file
41 X TOP -> <s> S </s> (1,1) [0..5] -2.900 <<0.000, -2.606, -9.711, 3.912>> 18
18 X S -> NP V NP (0,2) (1,1) (2,0) [1..4] -1.295 <<0.000, -1.737, -6.501, 3.912>> 11 5 8
11 X NP -> DT NN (0,0) (1,1) [1..2] -2.698 <<0.000, -0.869, -5.396, 0.000>> 2 4
2 X DT -> a [1..1] -1.012 <<0.000, -0.434, -2.024, 0.000>>
4 X NN -> house [2..2] -2.887 <<0.000, -0.434, -5.774, 0.000>>
5 X V -> is [3..3] -1.267 <<0.000, -0.434, -2.533, 0.000>>
8 X NP -> this [4..4] 0.486 <<0.000, -0.434, -1.330, 2.303>>
this is a house
```

The reordering in the sentence happens when hypothesis 18 is generated. The non-lexical rule  $S \rightarrow NP V NP$  takes the underlying children nodes in inverse order  $((0,2) (1,1) (2,0))$ .

Not any arbitrary reordering is allowed — as this can be the case in phrase models. Reordering has to be motivated by a translation rule. If the model uses real syntax, there has to be a syntactic justification for the reordering.

### 3.3.3 Decoder Parameters

The most important consideration in decoding is a speed/quality trade-off. If you want to win competitions, you want the best quality possible, even if it takes a week to translate 2000 sentences. If you want to provide an online service, you know that users get impatient, when they have to wait more than a second.

### Beam Settings

The chart decoder has an implementation of CKY decoding using cube pruning. The latter means that only a fixed number of hypotheses are generated for each span. This number can be changed with the option `cube-pruning-pop-limit` (or short `cbp`). The default is 1000, higher numbers slow down the decoder, but may result in better quality.

Another setting that directly affects speed is the number of rules that are considered for each input left hand side. It can be set with `ttable-limit`.

### Limiting Reordering

The number of spans that are filled during chart decoding is quadratic with respect to sentence length. But it gets worse. The number of spans that are combined into a span grows linear with sentence length for binary rules, quadratic for trinary rules, and so on. In short, long sentences become a problem. A drastic solution is the size of internal spans to a maximum number.

This sounds a bit extreme, but does make some sense for non-syntactic models. Reordering is limited in phrase-based models, and non-syntactic tree-based models (better known as hierarchical phrase-based models) and should limit reordering for the same reason: they are just not very good at long-distance reordering anyway.

The limit on span sizes can be set with `max-chart-span`. In fact its default is 10, which is not a useful setting for syntax models.

### Handling Unknown Words

In a target-syntax model, unknown words that just copied verbatim into the output need to get a non-terminal label. In practice unknown words tend to be open class words, most likely names, nouns, or numbers. With the option `unknown-lhs` you can specify a file that contains pairs of non-terminal labels and their probability per line.

Optionally, we can also model the choice of non-terminal for unknown words through sparse features, and optimize their cost through MIRA or PRO. This is implemented by relaxing the label matching constraint during decoding to allow soft matches, and allowing unknown words to expand to any non-terminal. To activate this feature:

```
use-unknown-word-soft-matches = true (in EMS config)
-unknown-word-label FILE1 -unknown-word-soft-matches FILE2 (in train-model.perl)
```

### Technical Settings

The parameter `non-terminals` is used to specify privileged non-terminals. These are used for unknown words (unless there is a unknown word label file) and to define the non-terminal label on the input side, when this is not specified.

Typically, we want to consider all possible rules that apply. However, with a large maximum phrase length, too many rule tables and no rule table limit, this may explode. The number of rules considered can be limited with `rule-limit`. Default is 5000.

### 3.3.4 Training

In short, training uses the identical training script as phrase-based models. When running `train-model.perl`, you will have to specify additional parameters, e.g. `-hierarchical` and `-glue-grammar`. You typically will also reduce the number of lexical items in the grammar with `-max-phrase-length 5`.

That's it.

#### Training Parameters

There are a number of additional decisions about the type of rules you may want to include in your model. This is typically a size / quality trade-off: Allowing more rule types increases the size of the rule table, but lead to better results. Bigger rule tables have a negative impact on memory use and speed of the decoder.

There are two parts to create a rule table: the extraction of rules and the scoring of rules. The first can be modified with the parameter `--extract-options="..."` of `train-model.perl`. The second with `--score-options="..."`.

Here are the extract options:

- `--OnlyDirect`: Only creates a model with direct conditional probabilities  $p(f|e)$  instead of the default direct and indirect ( $p(f|e)$  and  $p(e|f)$ ).
- `--MaxSpan SIZE`: maximum span size of the rule. Default is 15.
- `--MaxSymbolsSource SIZE` and `--MaxSymbolsTarget SIZE`: While a rule may be extracted from a large span, much of it may be knocked out by sub-phrases that are substituted by non-terminals. So, fewer actual symbols (non-terminals and words remain). The default maximum number of symbols is 5 for the source side, and practically unlimited (999) for the target side.
- `--MinWords SIZE`: minimum number of words in a rule. Default is 1, meaning that each rule has to have at least one word in it. If you want to allow non-lexical rules set this to zero. You will not want to do this for hierarchical models.
- `--AllowOnlyUnalignedWords`: This is related to the above. A rule may have words in it, but these may be unaligned words that are not connected. By default, at least one aligned word is required. Using this option, this requirement is dropped.
- `--MaxNonTerm SIZE`: the number of non-terminals on the right hand side of the rule. This has an effect on the arity of rules, in terms of non-terminals. Default is to generate only binary rules, so the setting is 2.
- `--MinHoleSource SIZE` and `--MinHoleTarget SIZE`: When sub-phrases are replaced by non-terminals, we may require a minimum size for these sub-phrases. The default is 2 on the source side and 1 (no limit) on the target side.
- `--DisallowNonTermConsecTarget` and `--NonTermConsecSource`. We may want to restrict if there can be neighboring non-terminals in rules. In hierarchical models there is a bad effect on decoding to allow neighboring non-terminals on the source side. The default is to disallow this -- it is allowed on the target side. These switches override the defaults.
- `--NoFractionalCounting`: For any given source span, any number of rules can be generated. By default, fractional counts are assigned, so probability of these rules adds up to one. This option leads to the count of one for each rule.

- `--NoNonTermFirstWord`: Disallows that a rule starts with a non-terminal.

Once rules are collected, the file of rules and their counts have to be converted into a probabilistic model. This is called rule scoring, and there are also some additional options:

- `--OnlyDirect`: only estimates direct conditional probabilities. Note that this option needs to be specified for both rule extraction and rule scoring.
- `--NoLex`: only includes rule-level conditional probabilities, not lexical scores.
- `--GoodTuring`: Uses Good Turing discounting to reduce actual accounts. This is a good thing, use it.

## Training Syntax Models

Training hierarchical phrase models, i.e., tree-based models without syntactic annotation, is pretty straight-forward. Adding syntactic labels to rules, either on the source side or the target side, is not much more complex. The main hurdle is to get the annotation. This requires a syntactic parser.

Syntactic annotation is provided by annotating all the training data (input or output side, or both) with syntactic labels. The format that is used for this uses XML markup. Here an example:

```
<tree label="NP"> <tree label="DET"> the </tree> \
<tree label="NN"> cat </tree> </tree>
```

So, constituents are surrounded by an opening and a closing `<tree>` tag, and the label is provided with the parameter `label`. The XML markup also allows for the placements of the tags in other positions, as long as a span parameter is provided:

```
<tree label="NP" span="0-1"/> <tree label="DET" span="0-0"/> \
<tree label="NN" span="1-1"/> the cat
```

After annotating the training data with syntactic information, you can simply run `train-model.perl` as before, except that the switches `--source-syntax` or `--target-syntax` (or both) have to be set.

You may also change some of the extraction settings, for instance `--MaxSpan 999`.

## Annotation Wrappers

To obtain the syntactic annotation, you will likely use a third-party parser, which has its own idiosyncratic input and output format. You will need to write a wrapper script that converts it into the Moses format for syntax trees.

We provide wrappers (in `scripts/training/wrapper`) for the following parsers.

- **Bitpar** is available from the web site of the University of Munich<sup>3</sup>. The wrapper is

<sup>3</sup><http://www.cis.uni-muenchen.de/~schmid/tools/BitPar/>

`parse-de-bitpar.perl`

- **Collins parser** is available from MIT<sup>4</sup>. The wrapper is `parse-en-collins.perl`

If you wrote your own wrapper for a publicly available parsers, please share it with us!

### Relaxing Parses

The use of syntactic annotation puts severe constraints on the number of rules that can be extracted, since each non-terminal has to correspond to an actual non-terminal in the syntax tree.

Recent research has proposed a number of relaxations of this constraint. The program `relax-parse` (in `training/phrase-extract`) implements two kinds of parse relaxations: binarization and a method proposed under the label of syntax-augmented machine translation (SAMT) by Zollmann and Venugopal.

Readers familiar with the concept of binarizing grammars in parsing, be warned: We are talking here about modifying parse trees, which changes the power of the extracted grammar, not binarization as a optimization step during decoding.

The idea is the following: If the training data contains a subtree such as



then it is not possible to extract translation rules for Ariel Sharon without additional syntactic context. Recall that each rule has to match a syntactic constituent.

The idea of relaxing the parse trees is to add additional internal nodes that makes the extraction of additional rules possible. For instance left-binarization adds two additional nodes and converts the subtree into:

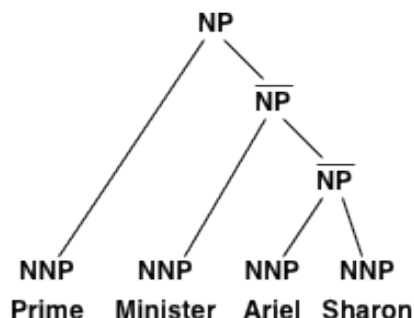

The additional node with the label  $\hat{NP}$  allows for the straight-forward extraction of a translation rule (of course, unless the word alignment does not provide a consistent alignment).

The program `relax-parse` allows the following tree transformations:

<sup>4</sup><http://people.csail.mit.edu/mcollins/code.html>

- `--LeftBinarize` and `--RightBinarize`: Adds internal nodes as in the example above. Right-binarization creates a right-branching tree.
- `--SAMT 1`: Combines pairs of neighboring children nodes into tags, such as `DET+ADJ`. Also nodes for everything except the first child (`NP` `DET`) and everything except the last child (`NP/NN`) are added.
- `--SAMT 2`: Combines any pairs of neighboring nodes, not only children nodes, e.g., `VP+DET`.
- `--SAMT 3`: not implemented.
- `--SAMT 4`: As above, but in addition each previously unlabeled node is labeled as `FAIL`, so no syntactic constraint on grammar constraint remains.

Note that you can also use both `--LeftBinarize` and `--RightBinarize`. Note that in this case, as with all the SAMT relaxations, the resulting annotation is not any more a tree, since there is not a single set of rule applications that generates the structure (now called a forest).

Here an example, what parse relaxation does to the number of rules extracted (English-German News Commentary, using Bitpar for German, no English syntax):

Relaxation Setting	Number of Rules
no syntax	59,079,493
basic syntax	2,291,400
left-binarized	2,914,348
right-binarized	2,979,830
SAMT 1	8,669,942
SAMT 2	35,164,756
SAMT 4	131,889,855

### On-Disk Rule Table

The rule table may become too big to fit into the RAM of the machine. Instead of loading the rules into memory, it is also possible to leave the rule table on disk, and retrieve rules on demand.

This is described in On-Disk Phrase Table<sup>5</sup>.

### 3.3.5 Using Meta-symbols in Non-terminal Symbols (e.g., CCG)

Often a syntactic formalism will use symbols that are part of the meta-symbols that denote non-terminal boundaries in the SCFG rule table, and glue grammar. For example, in Combinatory Categorical Grammar (CCG, Steedman, 2000), it is customary to denote grammatical features by placing them after the non-terminal symbol inside square brackets, as in `S[dcl]` (declarative sentence) vs. `S[q]` (interrogative sentence).

Although such annotations may be useful to discriminate good translations from bad, including square brackets in the non-terminal symbols themselves can confuse Moses. Some users have reported that category symbols were mangled (by splitting them at the square brackets) after converting to an on-disk representation (and potentially in other scenarios -- this is currently an open issue). A way to side-step this issue is to escape square brackets with a symbol that is not part of the meta-language of the grammar files, e.g. using the underscore symbol:

<sup>5</sup><http://www.statmt.org/moses/?n=Moses.AdvancedFeatures#ntoc4>

`S[decl] => S_decl_`

and

`S[q] => S_q_`

*before* extracting a grammar. This should be done in all data or tables that mention such syntactic categories. If the rule table is automatically extracted, it suffices to escape the categories in the `<tree label="..."...>` mark-up that is supplied to the training script. If you roll your own rule tables (or use an `unknown-lhs` file), you should make sure they are properly escaped.

### 3.3.6 Different Kinds of Syntax Models

#### String-to-Tree

Most SCFG-based machine translation decoders at the current time are designed to use hierarchical phrase-based grammar (Chiang, 2005) or syntactic grammar. Joshua, cdec, Jane are some of the open-sourced systems that have such decoders.

The hierarchical phrase-based grammar is well described elsewhere so we will not go into details here. Briefly, the non-terminals are not labelled with any linguistically-motivated labels. By convention, non-terminals have been simply labelled as `X`, e.g.

```
X --> der X1 ||| the X1
```

Usually, a set of glue rules are needed to ensure that the decoder always output an answer. By convention, the non-terminals for glue rules are labelled as `S`, e.g.

```
S --> <s> ||| <s>
S --> X1 </s> ||| X1 </s>
S --> X1 X2 ||| X1 X2
```

In a syntactic model, non-terminals are labelled with linguistically-motivated labels such as 'NOUN', 'VERB' etc. For example:

```
DET --> der ||| the
ADJ --> kleines ||| small
```

These labels are typically obtained by parsing the target side of the training corpus. (However, it is also possible to use parses of the source side which has been projected onto the target side (Ambati and Chen, 2007)).

The input to the decoder when using this model is a conventional string, as in phrase-based and hierarchical phrase-based models. The output is a string. However, the CFG-tree derivation of the output (target) can also be obtained (in Moses by using the -T argument), the non-terminals in this tree will be labelled with the linguistically-motivated labels.

For these reasons, these syntactic models are called 'target' syntax models, or 'string-to-tree' model, by many in the Moses community and elsewhere. (Some papers by people at ISI inverted this naming convention due to their adherence to the noisy-channel framework).

The implementation of string-to-tree models is fairly standard and similar across different open-source decoders such as Moses, Joshua, cdec and Jane.

There is a 'string-to-tree' model among the downloadable sample models<sup>6</sup>.

The input to the model is the string:

```
das ist ein kleines haus
```

The output string is

```
this is a small house
```

The target tree it produces is

```
(TOP <s> (S (NP this) (VP (V is) (NP (DT a) (ADJ small) (NN house)))) </s>)
```

**RECAP - The input is a string, the output is a tree with linguistically-motivated labels.**

### Tree-to-string

Unlike the string-to-tree model, the tree-to-string model is not as standardized across different decoders. This section describes the Moses implementation.

**Input tree representation** The input to the decoder is a parse tree, not a string. For Moses, the parse tree should be formatted using XML. The decoder converts the parse tree into an annotated string (a chart?). Each span in the chart is labelled with the non-terminal from the parse tree. For example, the input

<sup>6</sup><http://www.statmt.org/moses/download/sample-models.tgz>



```
<tree label="NP"> <tree label="DET"> the </tree> <tree label="NN"> cat </tree> </tree>
```

is converted to an annotated string

```
the  cat
-DET- -NN--
----NP-----
```

To support easier glue rules, the non-terminal 'X' is also added for every span in the annotated string. Therefore, the input above is actually converted to:

```
the  cat
-DET- -NN--
--X-- --X--
----NP-----
-----X-----
```

**Translation rules** During decoding, the non-terminal of the rule that spans a substring in the sentence must match the label on the annotated string. For example, the following rules can be applied to the above sentence.

```
NP --> the katze ||| die katze
NP --> the NN1 ||| der NN1
NP --> DET1 cat ||| DET1 katze
NP --> DET1 NN2 ||| DET1 NN2
```

However, these rules can't as they don't match one or more non-terminals.

```
VB --> the katze ||| die katze
NP --> the ADJ1 ||| der ADJ1
NP --> ADJ1 cat ||| ADJ1 katze
ADV --> ADJ1 NN2 ||| ADJ1 NN2
```

Therefore, non-terminal in the translation rules in a tree-to-string model acts as constraints on which rules can be applied. This constraint is in addition to the usual role of non-terminals.

A feature which is currently unique to the Moses decoder is the ability to separate out these two roles. Each non-terminal in all translation rules is represented by two labels:

1. The source non-terminal which constrains rules to the input parse tree
2. The target non-terminal which has the normal parsing role.

When we need to differentiate source and target non-terminals, the translation rules are instead written like this:

```
NP --> the NN1 ||| X --> der X1
```

This rule indicates that the non-terminal should span a NN constituent in the input text, and that the whole rule should span an NP constituent. The target non-terminals in this rule are both X, therefore, this rule would be considered part of tree-to-string grammar.

(Using this notation is probably wrong as the source sentence is not properly parsed - see next section. It may be better to express the Moses tree-to-string grammar as a hierarchical grammar, with added constraints. For example:

```
X --> the X1 ||| der X1 ||| LHS = NP, X_1 = NN
```

However, this may be even more confusing so we will stick with our convention for now.)

**RECAP - Grammar rules in Moses have 2 labels for each non-terminals; one to constrain the non-terminal to the input parse tree, the other is used in parsing.**

### Consequences

1. The Moses decoder always checks the source non-terminal, even when it is decoding with a string-to-string or string-to-tree grammar. For example, when checking whether the following rule can be applied

```
X --> der X1 ||| the X1
```

the decoder will check whether the RHS non-terminal, and the whole rule, spans an input parse constituent X. Therefore, even when decoding with a string-to-string or string-to-tree grammar, it is necessary to add the X non-terminal to every input span. For example, the input string the cat must be annotated as follows

```

the   cat
--X-- --X--
-----X-----

```

to allow the string to be decoded with a string-to-string or string-to-tree grammar.

2. There is no difference between a linguistically derived non-terminal label, such as NP, VP etc, and the non-linguistically motivated X label. They can both be used in one grammar, or even 1 translation rule. This 'mixed-syntax' model was explored in (Hoang and Koehn, 2010) and in Hieu Hoang's thesis<sup>7</sup>
3. The source non-terminals in translation rules are used just to constrain against the input parse tree, not for parsing. For example, if the input parse tree is

```
(VP (NP (PRO he)) (VB goes))
```

and tree-to-string rules are:

```

PRO --> he ||| X --> i1
VB --> goes ||| X --> va
VP --> NP1 VB2 ||| X --> X1 X2

```

This will create a valid translation. However, the span over the word 'he' will be labelled as PRO by the first rule, and NP by the 3rd rule. This is illustrated in more detail in Hieu's thesis Section 4.2.11.

4. To avoid the above and ensure that source spans are always consistently labelled, simply project the non-terminal label to both source and target. For example, change the rule

```
VP --> NP1 VB2 ||| X --> X1 X2
```

to

```
VP --> NP1 VB2 ||| VP --> NP1 VB2
```

<sup>7</sup><http://www.statmt.org/~s0565741/ddd.pdf>

### 3.3.7 Format of text rule table

The format of the Moses rule table is different from that used by Hiero, Joshua and cdec, and has often been a source of confusion. We shall attempt to explain the reasons in this section.

The format is derived from the Pharaoh/Moses phrase-based format. In this format, a translation rule

```
a b c --> d e f , with word alignments a1, a2 ..., and probabilities p1, p2, ...
```

is formatted as

```
a b c ||| d e f ||| p1 p2 ... ||| a1 a2 ...
```

For a hierarchical pb rule,

```
X --> a X1 b c X2 ||| d e f X2 X1
```

The Hiero/Joshua/cdec format is

```
X ||| a [X,1] b c [X,2] ||| d e f [X,2] [X,1] ||| p1 p2 ...
```

The Moses format is

```
a [X][X] b c [X][X] [X] ||| d e f [X][X] [X][X] [X] ||| p1 p2 ... ||| 1-4 4-3
```

For a string-to-tree rule,

```
VP --> a X1 b c X2 ||| d e f NP2 ADJ1
```

the Moses format is

```
a [X][ADJ] b c [X][NP] [X] ||| d e f [X][NP] [X][ADJ] [VP] ||| p1 p2 ... ||| 1-4 4-3
```

For a tree-to-string rule,

```
VP --> a ADJ1 b c NP2 ||| X --> d e f X2 X1
```

The Moses format is

```
a [ADJ][X] b c [NP][X] [VP] ||| d e f [NP][X] [ADJ][X] [X] ||| p1 p2 ... ||| 1-4 4-3
```

The main reasons for the difference between the Hiero/Joshua/cdec and Moses formats are as follows:

1. The text rule table should be easy to convert to a binary, on-disk format. We have seen in the community that this allows much larger models to be used during decoding, even on memory-limited servers. To make the conversion efficient, the text rule table must have the following properties:
  - (a) For every rule, the sequence of terminals and non-terminals in the first column (the 'source' column) should match the lookup sequence that the decoder will perform.
  - (b) The file can be sorted so that the first column is in alphabetical order. The decoder needs to look up the target non-terminals on the right-hand-side of each rule so the first column consists of source terminals and non-terminal, **and** target non-terminals from the right-hand-side.
2. The phrase probability calculations should be performed efficiently. To calculate  $p(t | s) = \text{count}(t,s) / \text{count}(s)$  the extract file must be sorted in contiguous order so that each count can be performed and used to calculate the probability, then discarded immediately to save memory. Similarly for  $p(s | t) = \text{count}(t,s) / \text{count}(t)$

The Hiero/Joshua/cdec file format is sufficient for hierarchical models, but not for the various syntax models supported by Moses.

*Subsection last modified on August 26, 2015, at 03:38 PM*

## 3.4 Optimizing Moses

### 3.4.1 Multi-threaded Moses

Moses supports multi-threaded operation, enabling faster decoding on multi-core machines. The current limitations of multi-threaded Moses are:

1. `irstlm` is not supported, since it uses a non-threadsafe cache
2. lattice input may not work - this has not been tested
3. increasing the verbosity of Moses will probably cause multi-threaded Moses to crash

Multi-threaded Moses is now built by default. If you omit the `-threads` argument, then Moses will use a single worker thread, and a thread to read the input stream. Using the argument `-threads n` specifies a pool of `n` threads, and `-threads all` will use all the cores on the machine.

### 3.4.2 How much memory do I need during decoding?

The single-most important thing you need to run Moses fast is **MEMORY**. Lots of **MEMORY**. (For example, the Edinburgh group have servers with 144GB of RAM). The rest of this section is just details of how to make the training and decoding run fast.

Calculate total file size of the binary phrase tables, binary language models and binary reordering models.

For example,

```
% ll -h phrase-table.0-0.1.1.binphr.*
-rw-r--r-- 1 s0565741 users 157K 2012-06-13 12:41 phrase-table.0-0.1.1.binphr.idx
-rw-r--r-- 1 s0565741 users 5.4M 2012-06-13 12:41 phrase-table.0-0.1.1.binphr.srctree
-rw-r--r-- 1 s0565741 users 282K 2012-06-13 12:41 phrase-table.0-0.1.1.binphr.srcvoc
-rw-r--r-- 1 s0565741 users 1.1G 2012-06-13 12:41 phrase-table.0-0.1.1.binphr.tgtdata
-rw-r--r-- 1 s0565741 users 1.7M 2012-06-13 12:41 phrase-table.0-0.1.1.binphr.tgtvoc
% ll -h reordering-table.1.wbe-msd-bidirectional-fe.binlexr.*
-rw-r--r-- 1 s0565741 users 157K 2012-06-13 13:36 reordering-table.1.wbe-msd-bidirectional-fe.binlexr.idx
-rw-r--r-- 1 s0565741 users 1.1G 2012-06-13 13:36 reordering-table.1.wbe-msd-bidirectional-fe.binlexr.srctree
-rw-r--r-- 1 s0565741 users 1.1G 2012-06-13 13:36 reordering-table.1.wbe-msd-bidirectional-fe.binlexr.tgtdata
-rw-r--r-- 1 s0565741 users 282K 2012-06-13 13:36 reordering-table.1.wbe-msd-bidirectional-fe.binlexr.voc0
-rw-r--r-- 1 s0565741 users 1.7M 2012-06-13 13:36 reordering-table.1.wbe-msd-bidirectional-fe.binlexr.voc1
% ll -h interpolated-binlm.1
-rw-r--r-- 1 s0565741 users 28G 2012-06-15 11:07 interpolated-binlm.1
```

The total size of these files is approx. 31GB. Therefore, a translation system using these models requires 31GB (+ roughly 500MB) of memory to run fast.

#### I've got this much memory but it's still slow. Why?

Run this:

```
cat phrase-table.0-0.1.1.binphr.* > /dev/null
cat reordering-table.1.wbe-msd-bidirectional-fe.binlexr.* > /dev/null
cat interpolated-binlm.1 > /dev/null
```

This forces the operating system to cache the binary models in memory, minimizing pages faults while the decoder is running. Other memory-intensive processes on the computer should not be running, otherwise the file-system cache may be reduced.

### Use huge pages

Moses does a lot of random lookups. If you're running Linux, check that transparent huge pages<sup>8</sup> are enabled. If

```
cat /sys/kernel/mm/transparent_hugepage/enabled
```

responds with

```
[always] madvise never
```

then transparent huge pages are enabled.

On some RedHat/Centos systems, the file is `/sys/kernel/mm/redhat_transparent_hugepage/enabled` and `madvise` will not appear. If neither file exists, upgrade the kernel to at least 2.6.38 and compile with `CONFIG_SPARSEMEM_VMEMMAP`. If the file exists, but the square brackets are not around "always", then run

```
echo always > /sys/kernel/mm/transparent_hugepage/enabled
```

as root (NB: to use `sudo`, quote the `>` character). This setting will not be preserved across reboots, so consider adding it to an init script.

### Use the compact phrase and reordering table representations to reduce memory usage by a factor of 10

See the manual on `binarized`<sup>9</sup> and `compact`<sup>10</sup> phrase table for a description how to compact your phrase tables. All the things said above for the standard binary phrase table are also true for the compact versions. The principle is the same, the total size of the binary files determines your memory usage, but since the combined size of the compact phrase table and the compact reordering model maybe up to 10 to 12 times smaller than with the original binary implementations, you will save exactly this much memory. You can also use the `--minphr-memory` and

---

<sup>8</sup><https://lwn.net/Articles/423584/>

<sup>9</sup><http://www.statmt.org/moses/?n=Moses.AdvancedFeatures#ntoc5>

<sup>10</sup><http://www.statmt.org/moses/?n=Moses.AdvancedFeatures#ntoc6>

--minlexr-memory options to load the tables into memory at Moses start-up instead of doing the above mentioned caching trick. This may take some time during warm-up, but may save a lot of time in the long term. If you are concerned for performance, see Junczys-Dowmunt (2012)<sup>11</sup> for a comparison. There is virtually no overhead due to on-the-fly decompression on large-memory-systems and considerable speed-up on systems with limited memory.

### 3.4.3 How little memory can I get away with during decoding?

The decoder can run on very little memory, about 200-300MB for phrase-based and 400-500MB for hierarchical decoding (according to Hieu). The decoder can run on an iPhone! And laptops. However, it will be VERY slow, unless you have very small models or the models are on fast disks such as flash disks.

### 3.4.4 Faster Training

#### Parallel training

When word aligning, using mgiza<sup>12</sup> with multiple threads significantly speed up word alignment.

**MGIZA** To use MGIZA with multiple threads in the Moses training script, add these arguments:

```
.../train-model.perl -mgiza -mgiza-cpus 8 ....
```

To enable it in the EMS, add this to the [TRAINING] section

```
[TRAINING]
training-options = "-mgiza -mgiza-cpus 8"
```

**snt2cooc** When running GIZA++ or MGIZA, the first stage involves running a program called

```
snt2cooc
```

<sup>11</sup><http://ufal.mff.cuni.cz/pbml/98/art-junczys-dowmunt.pdf>

<sup>12</sup><http://sourceforge.net/projects/mgizapp/>



This requires approximately 6GB+ for typical Europarl-size corpora (1.8 million sentences). For users without this amount of memory on their computers, an alternative version is included in MGIZA:

```
snt2cooc.pl
```

To use this script, you must copy 2 files to the same place where snt2cooc is run:

```
snt2cooc.pl  
snt2coocrpm
```

Add this argument when running the Moses training script:

```
.../train-model.perl -snt2cooc snt2cooc.pl
```

### **Parallel Extraction**

Once word alignment is completed, the phrase table is created from the aligned parallel corpus. There are 2 main ways to speed up this part of the training process.

Firstly, the training corpus and alignment can be split and phrase pairs from each part can be extracted simultaneously. This can be done by simply using the argument `-cores`, e.g.,

```
.../train-model.perl -cores 4
```

Secondly, the Unix `sort` command is often executed during training. It is essential to optimize this command to make use of the available disk and CPU. For example, recent versions of `sort` can take the following arguments

```
sort -S 10G --batch-size 253 --compress-program gzip --parallel 5
```

The Moses training script names these arguments

```
.../train-model.perl -sort-buffer-size 10G -sort-batch-size 253 \
-sort-compress gzip -sort-parallel 5
```

You should set these arguments. However, DO NOT just blindly copy the above settings, they must be tuned to the particular computer you are running on. The most important issues are:

1. you must make sure the version of sort on your machine supports the arguments you specify, otherwise the script will crash. The `--parallel`, `--compress-program`, and `--batch-size` arguments have only recently been added to the sort command.
2. make sure you have enough memory when setting `-sort-buffer-size`. In particular, you should take into account other programs running on the computer. Also, two or three simultaneous sort program will run (one to sort the extract file, one to sort `extract.inv`, one to sort `extract.o`). If there is not enough memory because you've set `sort-buffer-size` too high, your entire computer will likely crash.
3. the maximum number for the `--batch-size` argument is OS-dependent. For example, it is 1024 on Linux, 253 on old Mac OSX, 2557 on new OSX.
4. on Mac OSX, using `--compress-program` can occasionally result in the following timeout errors.

```
gsort: couldn't create process for gzip -d: Operation timed out
```

### 3.4.5 Training Summary

In summary, to maximize speed on a large server with many cores and up-to-date software, add this to your training script:

```
.../train-model.perl -mgiza -mgiza-cpus 8 -cores 10 \
-parallel -sort-buffer-size 10G -sort-batch-size 253 \
-sort-compress gzip -sort-parallel 10
```

To run on a laptop with limited memory

```
.../train-model.perl -mgiza -mgiza-cpus 2 -snt2cooc snt2cooc.pl \
-parallel -sort-batch-size 253 -sort-compress gzip
```

In the EMS, for large servers, this can be done by adding:

```
[TRAINING]
script = $moses-script-dir/training/train-model.perl
training-options = "-mgiza -mgiza-cpus 8 -cores 10 \
-parallel -sort-buffer-size 10G -sort-batch-size 253 \
-sort-compress gzip -sort-parallel 10"
parallel = yes
```

For servers with older OSes, and therefore older sort commands:

```
[TRAINING]
script = $moses-script-dir/training/train-model.perl
training-options = "-mgiza -mgiza-cpus 8 -cores 10 -parallel"
parallel = yes
```

For laptops with limited memory:

```
[TRAINING]
script = $moses-script-dir/training/train-model.perl
training-options = "-mgiza -mgiza-cpus 2 -snt2cooc snt2cooc.pl \
-parallel -sort-batch-size 253 -sort-compress gzip"
parallel = yes
```

### 3.4.6 Language Model

Convert your language model to binary format. This reduces loading time and provides more control.

#### Building a KenLM binary file

See the KenLM web site<sup>13</sup> for the time-memory tradeoff presented by the KenLM data structures. Use `bin/build_binary` (found in the same directory as `moses` and `moses_chart`) to convert ARPA files to the binary format. You can preview memory consumption with:

```
bin/build_binary file.arpa
```

<sup>13</sup><http://kheafield.com/code/kenlm/benchmark/>

This preview includes only the language model's memory usage, which is in addition to the phrase table etc. For speed, use the default probing data structure.

```
bin/build_binary file.arpa file.binlm
```

To save memory, change to the trie data structure

```
bin/build_binary trie file.arpa file.binlm
```

To further losslessly compress the trie ("chop" in the benchmarks), use `-a 64` which will compress pointers to a depth of up to 64 bits.

```
bin/build_binary -a 64 trie file.arpa file.binlm
```

Note that you can also make this parameter smaller which will go faster but use more memory. Quantization will make the trie smaller at the expense of accuracy. You can choose any number of bits from 2 to 25, for example 10:

```
bin/build_binary -a 64 -q 10 trie file.arpa file.binlm
```

Note that quantization can be used independently of `-a`.

### Loading on-demand

By default, language models fully load into memory at the beginning. If you are short on memory, you can use on-demand language model loading. The language model must be converted to binary format in advance and should be placed on LOCAL DISK, preferably SSD. For KenLM, you should use the trie data structure, not the probing data structure.

If the LM for binarized using IRSTLM, append `.mm` to the file name and change the ini file to reflect this. Eg. change

```
[feature]
IRSTLM .... path=file.lm
```

to

```
[feature]
IRSTLM .... path=file.lm.mm
```

If the LM was binarized using KenLM, add the argument `lazyken=true`. Eg. from

```
[feature]
KENLM ....
```

to

```
[feature]
KENLM .... lazyken=true
```

### 3.4.7 Suffix array

Suffix arrays store the entire parallel corpora and word alignment information in memory, instead of the phrase table. The parallel corpora and alignment file is often much smaller than the phrase table. For example, for the Europarl German-English (gzipped files):

```
de = 94MB
en = 84MB
alignment = 57MB

phrase-based = 2.0GB
hierarchical = 16.0GB
```

Therefore, it is more memory efficient to store the corpus in memory, rather than the entire phrase-table. This is usually structured as a suffix array to enable fast extraction of translations.

Translations are extracted as needed, usually per input test set, or per input sentence.

Moses support two different implementations of suffix arrays, one for phrase-based models<sup>14</sup>, [[one for hierarchical models -> `AdvancedFeatures#ntoc43`]].

<sup>14</sup><http://www.statmt.org/moses/?n=Moses.AdvancedFeatures#ntoc35>

### 3.4.8 Cube Pruning

Cube pruning limits the number of hypotheses created for each stack (or chart cell in chart decoding). It is essential for chart decoding (otherwise decoding will take a VERY long time) and an option in phrase-based decoding.

In the phrase-based decoder, add:

```
[search-algorithm]
1
[cube-pruning-pop-limit]
500
```

There is a speed-quality tradeoff, lower pop limit means less work for the decoder, so faster decoding but less accurate translation.

### 3.4.9 Minimizing memory during training

TODO: MGIZA with reduced memory sntcoc

### 3.4.10 Minimizing memory during decoding

The biggest consumer of memory during decoding are typically the models. Here are some links on how to reduce the size of each.

Language model:

```
* use KenLM with trie data structure Moses.Optimize#ntoc14\footnote{\sf http://www.statmt.org/moses/?n=Moses.Optimize#ntoc14}
* use on-demand loading Moses.Optimize#ntoc15\footnote{\sf http://www.statmt.org/moses/?n=Moses.Optimize#ntoc15}
```

Translation model:

```
* use phrase table pruning Advanced.RuleTables#ntoc5\footnote{\sf http://www.statmt.org/moses/?n=Advanced.RuleTables#ntoc5}
* use a compact phrase table http://www.statmt.org/moses/?n=Advanced.RuleTables#ntoc3
* filter the translation model given the text you want to translate Moses.SupportTools#ntoc3\footnote{\sf http://www.statmt.org/moses/?n=Moses.SupportTools#ntoc3}
```

Reordering model:



```
--static
```

This may mean you have to install Boost and zlib yourself.

Running single-threaded? Add `threading=single`.

Using hierarchical or string-to-tree models, but none with source syntax?

```
--unlabelled-source
```

### 3.4.11 Phrase-table types

Moses has multiple phrase table implementations. The one that suits you best depends on the model you're using (phrase-based or hierarchical/syntax), and how much memory your server has.

Here is a complete list of the types:

**Memory** - this read in the phrase table into memory. For phrase-based model and chart decoding. Note that this is much faster than Binary and OnDisk phrase table format, but it uses a lot of RAM.

**Binary** - a phrase table is converted into a 'database'. Only the translations which are required are loaded into memory. Therefore, requiring less memory, but potentially slower to run. For phrase-based model

**OnDisk** - reimplementation of Binary for chart decoding.

**SuffixArray** - stores the parallel training data and word alignment in memory, instead of the phrase table. Extraction is done on the fly. Also have a feature where you can add parallel data while the decoder is running ('Dynamic Suffix Array'). For Phrase-based models. See Levenberg et al., (2010)<sup>16</sup>.

**ALSuffixArray** - Suffix array for hierarchical models. See Lopez (2008)<sup>17</sup>.

**FuzzyMatch** - Implementation of Koehn and Senellart (2010)<sup>18</sup>.

**Hiero** - like SCFG, but translation rules are in standard Hiero-style format

**Compact** - for phrase-based model. See Junczys-Dowmunt (2012)<sup>19</sup>.

*Subsection last modified on March 07, 2015, at 10:24 AM*

<sup>16</sup><http://homepages.inf.ed.ac.uk/miles/papers/naacl10b.pdf>

<sup>17</sup><http://www.cs.jhu.edu/~alopez/talks/mtm2008-lopez.pdf>

<sup>18</sup><http://homepages.inf.ed.ac.uk/pkoehn/publications/tm-smt-amta2010.pdf>

<sup>19</sup><http://ufal.mff.cuni.cz/pbml/98/art-junczys-dowmunt.pdf>



## 3.5 Experiment Management System

### 3.5.1 Introduction

The Experiment Management System (EMS), or Experiment.perl, for lack of a better name, makes it much easier to perform experiments with Moses.

There are many steps in running an experiment: the preparation of training data, building language and translation models, tuning, testing, scoring and analysis of the results. For most of these steps, a different tool needs to be invoked, so this easily becomes very messy.

Here a typical example:

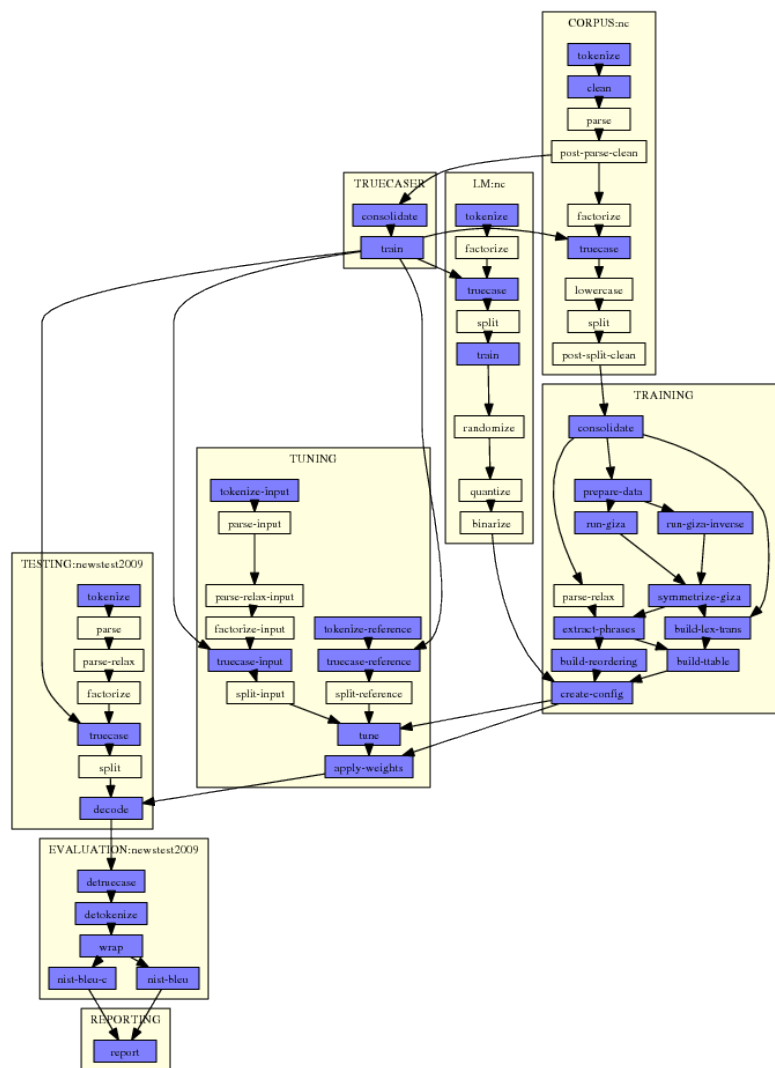

This graph was automatically generated by Experiment.perl. All that needed to be done was to specify one single configuration file that points to data files and settings for the experiment.

In the graph, each step is a small box. For each step, Experiment.perl builds a script file that gets either submitted to the cluster or run on the same machine. Note that some steps are quite

involved, for instance tuning: On a cluster, the tuning script runs on the head node and submits jobs to the queue itself.

Experiment.perl makes it easy to run multiple experimental runs with different settings or data resources. It automatically detects which steps do not have to be executed again but instead which results from an earlier run can be re-used.

Experiment.perl also offers a web interface to the experimental runs for easy access and comparison of experimental results.

### Task: WMT10 French-English (pkoehn)

[Wiki Notes](#) | [Overview of experiments](#) | /fs/saxnot1/pkoehn-experiment/wmt10-fr-en

compare	ID	start	end	newstest2009
<input type="checkbox"/> <a href="#">cfg par img</a> [1041-12]	7+Internal emplus test set	21 Apr	crashed	-
<input type="checkbox"/> <a href="#">cfg par img</a> [1041-11]	5+interpolated-tm.lm-weighted	19 Feb	20 Feb 14: 0.250695 -> 0.250672	26.30 (1.027) <a href="#">analysis</a> 27.36 (1.027) <input type="checkbox"/>
<input type="checkbox"/> <a href="#">cfg par img</a> [1041-10]	5+only-un	04 Feb	07 Feb 14: 0.242000 -> 0.242000	25.53 (1.026) <a href="#">analysis</a> 26.56 (1.026) <input type="checkbox"/>
<input type="checkbox"/> <a href="#">cfg par img</a> [1041-9]	5+only-ep	05 Feb	06 Feb 12: 0.242005 -> 0.242115	25.43 (1.034) <a href="#">analysis</a> 26.49 (1.034) <input type="checkbox"/>
<input type="checkbox"/> <a href="#">cfg par img</a> [1041-8]	5+only-nc	04 Feb	05 Feb 19: 0.225010 -> 0.225012	23.62 (1.023) <a href="#">analysis</a> 24.54 (1.023) <input type="checkbox"/>
<input type="checkbox"/> <a href="#">cfg par img</a> [1041-7]	5+pop20,000+ttl50	19 Feb	19 Feb	26.07 (1.027) <a href="#">analysis</a> 27.11 (1.027) <input type="checkbox"/>
<input type="checkbox"/> <a href="#">cfg par img</a> [1041-6]	5+pop20,000	19 Feb	19 Feb	26.11 (1.026) <a href="#">analysis</a> 27.16 (1.026) <input type="checkbox"/>
<input type="checkbox"/> <a href="#">cfg par img</a> [1041-5]	2+pos-lm	19 Feb	19 Feb 8: 0.247901 -> 0.247902	26.13 (1.026) <a href="#">analysis</a> 27.16 (1.026) <input checked="" type="checkbox"/>
<input type="checkbox"/> <a href="#">cfg par img</a> [1041-4]	3+w/o GoodTuring	18 Jan	18 Jan 8: 0.240555 -> 0.240555	25.23 (1.025) <a href="#">analysis</a> 26.29 (1.025) <input type="checkbox"/>
<input type="checkbox"/> <a href="#">cfg par img</a> [1041-3]	2+w/o UN	17 Jan	18 Jan 17: 0.242442 -> 0.242442	25.37 (1.024) <a href="#">analysis</a> 26.47 (1.024) <input type="checkbox"/>
<input type="checkbox"/> <a href="#">cfg par img</a> [1041-2]	baseline GIZA++	10 Feb	10 Feb 14: 0.247919 -> 0.247950	25.92 (1.025) <a href="#">analysis</a> 26.93 (1.025) <input checked="" type="checkbox"/>
<input type="checkbox"/> <a href="#">cfg par img</a> [1041-1]	baseline Berkeley	18 Jan	crashed	-

The web interface also offers some basic analysis of results, such as comparing the n-gram matches between two different experimental runs:

#### Analysis: WMT10 English-German (pkoehn), Set newstest2010, Run 13

Precision	Metrics	Coverage
precision 1-gram 2-gram 3-gram 4-gram correct 31719 13052 6406 3289 52.8% 22.7% 11.6% 6.3% wrong 28329 44507 48665 49307 <a href="#">details</a>	BLEU-c BLEU 16.30 (0.962) 16.68 (0.962) length-diff: -2383 (-3.8%)	model corpus 0 1829 (2.9%) 1486 (2.4%) 1 to 2 1 577 (0.9%) 410 (0.7%) 2 to 2-5 1220 (1.9%) 632 (1.0%) 3 to 6+ 59420 (94.2%) 60518 (96.0%) 4+ to by token / <a href="#">by type</a> / <a href="#">details</a>
<b>annotated sentences</b> sorted by order <a href="#">best</a> <a href="#">worst</a> showing 5 <a href="#">more</a> <a href="#">all</a>		
<p>[*0]</p> <p>Barack Obama becomes the fourth American president to receive the Nobel Peace Prize  <small>[0.2521]</small> Barack Obama wird der vierte amerikanische Präsident den Friedensnobelpreis erhalten          Barack Obama erhält als vierter US @-@ Präsident den Friedensnobelpreis</p>		

## 3.5.2 Requirements

In order to run properly, EMS will require:

- A version of Moses along with SRILM,
- The GraphViz toolkit<sup>20</sup>,
- The ImageMagick toolkit<sup>21</sup>, and

<sup>20</sup><http://www.graphviz.org/>

<sup>21</sup><http://www.imagemagick.org/script/index.php>

- The GhostView tool<sup>22</sup>.

### 3.5.3 Quick Start

Experiment.perl is extremely simple to use:

- Find `experiment.perl` in `scripts/ems`
- Get a sample configuration file from someplace (for instance `scripts/ems/example/config.toy`).
- Set up a working directory for your experiments for this task (`mkdir` does it).
- Edit the following path settings in `config.toy`
  - `working-dir`
  - `data-dir`
  - `moses-script-dir`
  - `moses-src-dir`
  - `srilm-dir`
  - `decoder`
- Run `experiment.perl -config config.toy` from your experiment working directory.
- Marvel at the graphical plan of action.
- Run `experiment.perl -config config.toy -exec`.
- Check the results of your experiment (in `evaluation/report.1`)

Let us take a closer look at what just happened.

The configuration file `config.toy` consists of several sections. For instance there is a section for each language model corpus to be used. In our toy example, this section contains the following:

```
[LM:toy]

### raw corpus (untokenized)
#
raw-corpus = $toy-data/nc-5k.$output-extension
```

The setting `raw-corpus` species the location of the corpus. The definition uses the variables `$toy-data` and `$output-extension`, which are also settings defined elsewhere in the configuration file. These variables are resolved, leading to the file path `ems/examples/data/nc-5k.en` in your Moses scripts directory.

The authoritative definition of the steps and their interaction is in the file `experiment.meta` (in the same directory as `experiment.perl`: `scripts/ems`).

The logic of `experiment.meta` is that it wants to create a report at the end. To generate the report it needs to evaluation scores, to get these it needs decoding output, to get these it needs to run the decoder, to be able to run the decoder it needs a trained model, to train a model it needs data. This process of defining the agenda of steps to be executed is very similar to the Make utility in Unix.

We can find the following step definitions for the language model module in `experiment.meta`:

<sup>22</sup><http://www.gnu.org/software/gv/>

```

get-corpus
in: get-corpus-script
out: raw-corpus
default-name: lm/txt
template: IN > OUT
tokenize
in: raw-corpus
out: tokenized-corpus
default-name: lm/tok
pass-unless: output-tokenizer
template: $output-tokenizer < IN > OUT
parallelizable: yes

```

The tokenization step `tokenize` requires `raw-corpus` as input. In our case, we specified the setting in the configuration file. We could have also specified an already tokenized corpus with `tokenized-corpus`. This would allow us to skip the tokenization step. Or, to give another example, we could have not specified `raw-corpus`, but rather specify a script that generates the corpus with the setting `get-corpus-script`. This would have triggered the creation of the step `get-corpus`.

The steps are linked with the definition of their input `in` and output `out`. Each step has also a default name for the output (`default-name`) and other settings.

The tokenization step has as default name `lm/tok`. Let us look at the directory `lm` to see which files it contains:

```

% ls -tr lm/*
lm/toy.tok.1
lm/toy.truecased.1
lm/toy.lm.1

```

We find the output of the tokenization step in the file `lm/toy.tok.1`. The `toy` was added from the name definition of the language model (see `[LM:toy]` in `config.toy`). The `1` was added, because this is the first experimental run.

The directory `steps` contains the script that executes each step, its `STDERR` and `STDOUT` output, and meta-information. For instance:

```

% ls steps/1/LM_toy_tokenize.1* | cat
steps/1/LM_toy_tokenize.1
steps/1/LM_toy_tokenize.1.DONE
steps/1/LM_toy_tokenize.1.INFO

```

```
steps/1/LM_toy_tokenize.1.STDERR
steps/1/LM_toy_tokenize.1.STDERR.digest
steps/1/LM_toy_tokenize.1.STDOUT
```

The file `steps/2/LM_toy_tokenize.2` is the script that is run to execute the step. The file with the extension `DONE` is created when the step is finished - this communicates to the scheduler that subsequent steps can be executed. The file with the extension `INFO` contains meta-information - essential the settings and dependencies of the step. This file is checked to detect if a step can be re-used in new experimental runs.

In case that the step crashed, we expect some indication of a fault in `STDERR` (for instance the words `core dumped` or `killed`). This file is checked to see if the step was executed successfully, so subsequent steps can be scheduled or the step can be re-used in new experiments. Since the `STDERR` file may be very large (some steps create megabytes of such output), a digested version is created in `STDERR.digest`. If the step was successful, it is empty. Otherwise it contains the error pattern that triggered the failure detection.

Let us now take a closer look at re-use. If we run the experiment again but change some of the settings, say, the order of the language model, then there is no need to re-run the tokenization.

Here is the definition of the language model training step in `experiment.meta`:

```
train
in: split-corpus
out: lm
default-name: lm/lm
ignore-if: rlm-training
rerun-on-change: lm-training order settings
template: $lm-training -order $order $settings -text IN -lm OUT
error: cannot execute binary file
```

The mention of `order` in the list behind `rerun-on-change` informs `experiment.perl` that this step does need to be re-run, if the order of the language model changes. Since none of the settings in the chain of steps leading up to the training have been changed, the step can be re-used.

Try changing the language model order (`order = 5` in `config.toy`), run `experiment.perl` again (`experiment.perl -config config.toy`) in the working directory, and you will see the new language model in the directory `lm`:

```
% ls -tr lm/*
lm/toy.tok.1
lm/toy.truecased.1
lm/toy.lm.1
lm/toy.lm.2
```

### 3.5.4 More Examples

The example directory contains some additional examples.

These require the training and tuning data released for the Shared Translation Task for WMT 2010. Create a working directory, and change into it. Then execute the following steps:

```
mkdir data
cd data
wget http://www.statmt.org/wmt10/training-parallel.tgz
tar xzf training-parallel.tgz
wget http://www.statmt.org/wmt10/dev.tgz
tar xzf dev.tgz
cd ..
```

The examples using these corpora are

- `config.basic` - a basic phrase based model,
- `config.factored` - a factored phrase based model,
- `config.hierarchical` - a hierarchical phrase based model, and
- `config.syntax` - a target syntax model.

In all these example configuration files, most corpora are commented out. This is done by adding the word `IGNORE` at the end of a corpus definition (also for the language models). This allows you to run a basic experiment with just the News Commentary corpus which finished relatively quickly. Remove the `IGNORE` to include more training data. You may run into memory and disk space problems when using some of the larger corpora (especially the news language model), depending on your computing infrastructure.

If you decide to use multiple corpora for the language model, you may also want to try out interpolating the individual language models (instead of using them as separate feature functions). For this, you need to comment out the `IGNORE` next to the `[INTERPOLATED-LM]` section.

You may also specify different language pairs by changing the `input-extension`, `output-extension`, and `pair-extension` settings.

Finally, you can run all the experiments with the different given configuration files and the data variations in the same working directory. The experimental management system figures out automatically which processing steps do not need to be repeated because they can be re-used from prior experimental runs.

#### Phrase Model

Phrase models are, compared to the following examples, the simplest models to be trained with Moses and the fastest models to run. You may prefer these models over the more sophisticated models whose added complexity may not justify the small (if any) gains.

The example `config.basic` is similar to the toy example, except for a larger training and test corpora. Also, the tuning stage is not skipped. Thus, even with most of the corpora commented out, the entire experimental run will likely take a day, with most time taken up by word alignment (`TRAINING_run-giza` and `TRAINING_run-giza-inverse`) and tuning (`TUNING_tune`).

### Factored Phrase Model

Factored models allow for additional annotation at the word level which may be exploited in various models. The example in `config.factored` uses part-of-speech tags on the English target side.

Annotation with part-of-speech tags is done with MXPOST, which needs to be installed first. Please read the installation instructions<sup>23</sup>. After this, you can run `experiment.perl` with the configuration file `config.factored`.

If you compare the factored example `config.factored` with the phrase-based example `config.basic`, you will notice the definition of the factors used:

```
### factored training: specify here which factors used
# if none specified, single factor training is assumed
# (one translation step, surface to surface)
#
input-factors = word
output-factors = word pos
alignment-factors = "word -> word"
translation-factors = "word -> word+pos"
reordering-factors = "word -> word"
#generation-factors =
decoding-steps = "t0"
```

the factor definition:

```
#####
# FACTOR DEFINITION

[INPUT-FACTOR]

# also used for output factors
temp-dir = $working-dir/training/factor

[OUTPUT-FACTOR:pos]

### script that generates this factor
#
mxpost = /home/pkoehn/bin/mxpost
factor-script = "$moses-script-dir/training/wrappers/make-factor-en-pos.mxpost.perl -mxpost $mxpost"
```

and the specification of a 7-gram language model over part of speech tags:

<sup>23</sup><http://www.statmt.org/moses/?n=Moses.ExternalTools#mxpost>

```
[LM:nc=pos]
factors = "pos"
order = 7
settings = "-interpolate -unk"
raw-corpus = $wmt10-data/training/news-commentary10.$pair-extension.$output-extension
```

This factored model using all the available corpora is identical to the Edinburgh submission to the WMT 2010 shared task for English-Spanish, Spanish-English, and English-German language pairs (the French language pairs also used the 10<sup>9</sup> corpus, the Czech language pairs did not use the POS language model, and German-English used additional pre-processing steps).

### Hierarchical model

Hierarchical phrase models allow for rules with gaps. Since these are represented by non-terminals and such rules are best processed with a search algorithm that is similar to syntactic chart parsing, such models fall into the class of tree-based or grammar-based models. For more information, please check the Syntax Tutorial (Section 3.3).

From the view of setting up hierarchical models with `experiment.perl`, very little has to be changed in comparison to the configuration file for phrase-based models:

```
% diff config.basic config.hierarchical
33c33
< decoder = $moses-src-dir/bin/moses
---
> decoder = $moses-src-dir/bin/moses_chart
36c36
< ttable-binarizer = $moses-src-dir/bin/processPhraseTable
---
> #ttable-binarizer = $moses-src-dir/bin/processPhraseTable
39c39
< #ttable-binarizer = "$moses-src-dir/bin/CreateOnDiskPt 1 1 5 100 2"
---
> ttable-binarizer = "$moses-src-dir/bin/CreateOnDiskPt 1 1 5 100 2"
280c280
< lexicalized-reordering = msd-bidirectional-fe
---
> #lexicalized-reordering = msd-bidirectional-fe
284c284
< #hierarchical-rule-set = true
---
> hierarchical-rule-set = true
413c413
```



```
< decoder-settings = "-search-algorithm 1 -cube-pruning-pop-limit 5000 -s 5000"
---
> #decoder-settings = ""
```

The changes are: a different decoder binary (by default compiled into `bin/moses_chart`) and `ttable-binarizer` are used. The decoder settings for phrasal cube pruning do not apply. Also, hierarchical models do not allow for lexicalized reordering (their rules fulfill the same purpose), and the setting for hierarchical rule sets has to be turned on. The use of hierarchical rules is indicated with the setting `hierarchical-rule-set`.

### Target syntax model

Syntax models imply the use of linguistic annotation for the non-terminals of hierarchical models. This requires running a syntactic parser.

In our example `config.syntax`, `syntax` is used only on the English target side. The syntactic constituents are labeled with Collins parser, which needs to be installed first. Please read the installation instructions<sup>24</sup>.

Compared to the hierarchical model, very little has to be changed in the configuration file:

```
% diff config.hierarchical config.syntax
46a47,49
> # syntactic parsers
> collins = /home/pkoeHN/bin/COLLINS-PARSER
> output-parser = "$moses-script-dir/training/wrappers/parse-en-collins.perl"
>
241c244
< #extract-settings = ""
---
> extract-settings = "--MinHoleSource 1 --NonTermConsecSource"
```

The parser needs to be specified, and the extraction settings may be adjusted. And you are ready to go.

### 3.5.5 Try a Few More Things

#### Stemmed Word Alignment

The factored translation model training makes it very easy to set up word alignment not based on the surface form of words, but any other property of a word. One relatively popular method is to use stemmed words for word alignment.

<sup>24</sup><http://www.statmt.org/moses/?n=Moses.ExternalTools#collins>

There are two reasons for this: For one, for morphologically rich languages, stemming overcomes data sparsity problems. Secondly, GIZA++ may have difficulties with very large vocabulary sizes, and stemming reduces the number of unique words.

To set up stemmed word alignment in `experiment.perl`, you need to define a stem as a factor:

```
[OUTPUT-FACTOR:stem4]
factor-script = "$moses-script-dir/training/wrappers/make-factor-stem.perl 4"

[INPUT-FACTOR:stem4]
factor-script = "$moses-script-dir/training/wrappers/make-factor-stem.perl 4"
```

and indicate the use of this factor in the TRAINING section:

```
input-factors = word stem4
output-factors = word stem4
alignment-factors = "stem4 -> stem4"
translation-factors = "word -> word"
reordering-factors = "word -> word"
#generation-factors =
decoding-steps = "t0"
```

### Using Multi-Threaded GIZA++

GIZA++ is one of the slowest steps in the training pipeline. Qin Gao implemented a multi-threaded version of GIZA++, called MGIZA, which speeds up word alignment on multi-core machines.

To use MGIZA, you will first need to install<sup>25</sup> it.

To use it, you simply need to add some training options in the section TRAINING:

```
### general options
#
training-options = "-mgiza -mgiza-cpus 8"
```

<sup>25</sup><http://www.statmt.org/moses/?n=Moses.ExternalTools#mgiza>

### Using Berkeley Aligner

The Berkeley Aligner is an alternative to GIZA++ for word alignment. You may (or may not) get better results using this tool.

To use the Berkeley Aligner, you will first need to install<sup>26</sup> it.

The example configuration file already has a section for the parameters for the tool. You need to un-comment them and adjust `berkeley-jar` to your installation. You should comment out `alignment-symmetrization-method`, since this is a GIZA++ setting.

```
### symmetrization method to obtain word alignments from giza output
# (commonly used: grow-diag-final-and)
#
#alignment-symmetrization-method = grow-diag-final-and

### use of berkeley aligner for word alignment
#
use-berkeley = true
alignment-symmetrization-method = berkeley
berkeley-train = $moses-script-dir/ems/support/berkeley-train.sh
berkeley-process = $moses-script-dir/ems/support/berkeley-process.sh
berkeley-jar = /your/path/to/berkeleyaligner-2.1/berkeleyaligner.jar
berkeley-java-options = "-server -mx30000m -ea"
berkeley-training-options = "-Main.iters 5 5 -EMWordAligner.numThreads 8"
berkeley-process-options = "-EMWordAligner.numThreads 8"
berkeley-posterior = 0.5
```

The Berkeley Aligner proceeds in two steps: a training step to learn the alignment model from the data and a processing step to find the best alignment for the training data. This step has the parameter `berkeley-posterior` to adjust a bias towards more or less alignment points. You can try different runs with different values for this parameter. `Experiment.perl` will not re-run the training step, just the processing step.

### Using Dyer's Fast Align

Another alternative to GIZA++ is `fast_align` from Dyer et al.<sup>27</sup>. It runs much faster, and may even give better results, especially for language pairs without much large-scale reordering.

To use Fast Align, you will first need to install<sup>28</sup> it.

The example configuration file already has an example setting for the tool, using the recommended defaults. Just remove the comment marker `###` before the setting:

<sup>26</sup><http://www.statmt.org/moses/?n=Moses.ExternalTools#berkeley>

<sup>27</sup>[http://www.ark.cs.cmu.edu/cdyer/fast\\_valign.pdf](http://www.ark.cs.cmu.edu/cdyer/fast_valign.pdf)

<sup>28</sup><http://www.statmt.org/moses/?n=Moses.ExternalTools#fastalign>

```
### use of Chris Dyer's fast align for word alignment
#
fast-align-settings = "-d -o -v"
```

Experiment.perl assumes that you copied the binary into the usual external bin dir (setting external-bin-dir) where GIZA++ and other external binaries are located.

### IRST Language Model

The provided examples use the SRI language model during decoding. When you want to use the IRSTLM instead, an additional processing step is required: the language model has to be converted into a binary format.

This part of the LM section defines the use of IRSTLM:

```
### script to use for binary table format for irstlm
# (default: no binarization)
#
#lm-binarizer = $moses-src-dir/irstlm/bin/compile-lm

### script to create quantized language model format (irstlm)
# (default: no quantization)
#
#lm-quantizer = $moses-src-dir/irstlm/bin/quantize-lm
```

If you un-comment `lm-binarizer`, IRSTLM will be used. If you comment out in addition `lm-quantizer`, the language model will be compressed into a more compact representation. Note that the values above assume that you installed the IRSTLM toolkit in the directory `$moses-src-dir/irstlm`.

### Randomized Language Model

Randomized language models allow a much more compact (but lossy) representation. Being able to use much larger corpora for the language model may be beneficial over the small chance of making mistakes.

First of all, you need to install<sup>29</sup> the RandLM toolkit.

There are two different ways to train a randomized language model. One is to train it from scratch. The other way is to convert a SRI language model into randomized representation.

<sup>29</sup><http://www.statmt.org/moses/?n=FactoredTraining.BuildingLanguageModel#randlm>

**Training from scratch:** Find the following section in the example configuration files and un-comment the `rlm-training` setting. Note that the section below assumes that you installed the randomized language model toolkit in the directory `$moses-src-dir/randlm`.

```
### tool to be used for training randomized language model from scratch
# (more commonly, a SRILM is trained)
#
rlm-training = "$moses-src-dir/randlm/bin/buildlm -falsepos 8 -values 8"
```

**Converting SRI language model:** Find the following section in the example configuration files and un-comment the `lm-randomizer` setting.

```
### script to use for converting into randomized table format
# (default: no randomization)
#
lm-randomizer = "$moses-src-dir/randlm/bin/buildlm -falsepos 8 -values 8"
```

You may want to try other values for `falsepos` and `values`. Please see the language model section on RandLM<sup>30</sup> for some more information about these parameters.

You can also randomize a interpolated language model by specifying the `lm-randomizer` in the section `INTERPOLATED-LM`.

### Compound Splitting

Compounding languages, such as German, allow the creation of long words such as *Neuwort-generierung* (*new word generation*). This results in a lot of unknown words in any text, so splitting up these compounds is a common method when translating from such languages.

Moses offers a support tool that splits up words, if the geometric average of the frequency of its parts is higher than the frequency of a word. The method requires a model (the frequency statistics of words in a corpus), so there is a training and application step.

Such word splitting can be added to `experiment.perl` simply by specifying the splitter script in the `GENERAL` section:

```
input-splitter = $moses-script-dir/generic/compound-splitter.perl
```

Splitting words on the output side is currently not supported.

<sup>30</sup><http://www.statmt.org/moses/?n=FactoredTraining.BuildingLanguageModel#randlm>

### 3.5.6 A Short Manual

The basic lay of the land is: `experiment.perl` breaks up the training, tuning, and evaluating of a statistical machine translation system into a number of steps, which are then scheduled to run in parallel or sequence depending on their inter-dependencies and available resources. The possible steps are defined in the file `experiment.meta`. An experiment is defined by a configuration file.

The main modules of running an experiment are:

- **CORPUS**: preparing a parallel corpus,
- **INPUT-FACTOR** and **OUTPUT-FACTOR**: commands to create factors,
- **TRAINING**: training a translation model,
- **LM**: training a language model,
- **INTERPOLATED-LM**: interpolate language models,
- **SPLITTER**: training a word splitting model,
- **RECASING**: training a recaser,
- **TRUCCASING**: training a truecaser,
- **TUNING**: running minimum error rate training to set component weights,
- **TESTING**: translating and scoring a test set, and
- **REPORTING**: compile all scores in one file.

#### Experiment.Meta

The actual steps, their dependencies and other salient information are to be found in the file `experiment.meta`. Think of `experiment.meta` as a "template" file.

Here the parts of the step description for `CORPUS:get-corporus` and `CORPUS:tokenize`:

```
get-corporus
in: get-corporus-script
out: raw-stem
[...]

tokenize
in: raw-stem
out: tokenized-stem
[...]
```

Each step takes some input (`in`) and provides some output (`out`). This also establishes the dependencies between the steps. The step `tokenize` requires the input `raw-stem`. This is provided by the step `get-corporus`.

`experiment.meta` provides a generic template for steps and their interaction. For an actual experiment, a configuration file determines which steps need to be run. This configuration file is the one that is specified when invoking `experiment.perl`. It may contain for instance the following:

```
[CORPUS:europarl]

### raw corpus files (untokenized, but sentence aligned)
#
raw-stem = $europarl-v3/training/europarl-v3.fr-en
```

Here, the parallel corpus to be used is named `europarl` and it is provided in raw text format in the location `$europarl-v3/training/europarl-v3.fr-en` (the variable `$europarl-v3` is defined elsewhere in the config file). The effect of this specification in the config file is that the step `get-corpus` does not need to be run, since its output is given as a file. More on the configuration file below in the next section.

Several types of information are specified in `experiment.meta`:

- `in` and `out`: Established dependencies between steps; input may also be provided by files specified in the configuration.
- `default-name`: Name of the file in which the output of the step will be stored.
- `template`: Template for the command that is placed in the execution script for the step.
- `template-if`: Potential command for the execution script. Only used, if the first parameter exists.
- `error`: `experiment.perl` detects if a step failed by scanning `STDERR` for key words such as `killed`, `error`, `died`, `not found`, and so on. Additional key words and phrase are provided with this parameter.
- `not-error`: Declares default error key words as not indicating failures.
- `pass-unless`: Only if the given parameter is defined, this step is executed, otherwise the step is passed (illustrated by a yellow box in the graph).
- `ignore-unless`: If the given parameter is defined, this step is not executed. This overrides requirements of downstream steps.
- `rerun-on-change`: If similar experiments are run, the output of steps may be used, if input and parameter settings are the same. This specifies a number of parameters whose change disallows a re-use in different run.
- `parallelizable`: When running on the cluster, this step may be parallelized (only if `generic-parallelizer` is set in the config file, the script can be found in `$moses-script-dir/scripts/ems/`).
- `qsub-script`: If running on a cluster, this step is run on the head node, and not submitted to the queue (because it submits jobs itself).

Here now the full definition of the step `CONFIG:tokenize`

```
tokenize
in: raw-stem
out: tokenized-stem
default-name: corpus/tok
pass-unless: input-tokenizer output-tokenizer
template-if: input-tokenizer IN.$input-extension OUT.$input-extension
template-if: output-tokenizer IN.$output-extension OUT.$output-extension
parallelizable: yes
```

The step takes `raw-stem` and produces `tokenized-stem`. It is parallelizable with the generic parallelizer.

That output is stored in the file `corpus/tok`. Note that the actual file name also contains the corpus name, and the run number. Also, in this case, the parallel corpus is stored in two files, so file name may be something like `corpus/europarl.tok.1.fr` and `corpus/europarl.tok.1.en`.

The step is only executed, if either `input-tokenizer` or `output-tokenizer` are specified. The templates indicate how the command lines in the execution script for the steps look like.

### Multiple Corpora, One Translation Model

We may use multiple parallel corpora for training a translation model or multiple monolingual corpora for training a language model. Each of these have their own instances of the `CORPUS` and `LM` module. There may be also multiple test sets in `TESTING`). However, there is only one translation model and hence only one instance of the `TRAINING` module.

The definitions in `experiment.meta` reflect the different nature of these modules. For instance `CORPUS` is flagged as `multiple`, while `TRAINING` is flagged as `single`.

When defining settings for the different modules, the singular module `TRAINING` has only one section, while this one general section and specific `LM` sections for each training corpus. In the specific section, the corpus is named, e.g. `LM:europarl`.

As you may imagine, the tracking of dependencies between steps of different types of modules and the consolidation of corpus-specific instances of modules is a bit complex. But most of that is hidden from the user of the Experimental Management System.

When looking up the parameter settings for a step, first the set-specific section (`LM:europarl`) is consulted. If there is no definition, then the module definition (`LM`) and finally the general definition (in section `GENERAL`) is consulted. In other words, local settings override global settings.

### Defining Settings

The configuration file for experimental runs is a collection of parameter settings, one per line with empty lines and comment lines for better readability, organized in sections for each of the modules.

The syntax of setting definition is `setting = value` (note: spaces around the equal sign). If the value contains spaces, it must be placed into quotes (`setting = "the value"`), except when a vector of values is implied (only used when defining list of factors: `output-factor = word pos`).

Comments are indicated by a hash (`#`).

The start of sections is indicated by the section name in square brackets (`[TRAINING]` or `[CORPUS:europarl]`). If the word `IGNORE` is appended to a section definition, then the entire section is ignored.

Settings can be used as variables to define other settings:



```
working-dir = /home/pkoehn/experiment
wmt10-data = $working-dir/data
```

Variable names may be placed in curly brackets for clearer separation:

```
wmt10-data = ${working-dir}/data
```

Such variable references may also reach other modules:

```
[RECASING]
tokenized = $LM:europarl:tokenized-corpus
```

Finally, reference can be made to settings that are not defined in the configuration file, but are the product of the defined sequence of steps.

Say, in the above example, `tokenized-corpus` is not defined in the section `LM:europarl`, but instead `raw-corpus`. Then, the tokenized corpus is produced by the normal processing pipeline. Such an intermediate file can be used elsewhere:

```
[RECASING]
tokenized = [LM:europarl:tokenized-corpus]
```

Some error checking is done on the validity of the values. All values that seem to be file paths trigger the existence check for such files. A file with the prefix of the value must exist.

There are a lot of settings reflecting the many steps, and explaining these would require explaining the entire training, tuning, and testing pipeline. Please find the required documentation for step elsewhere around here. Every effort has been made to include verbose descriptions in the example configuration files, which should be taken as starting point.

### Working with Experiment.Pperl

You have to define an experiment in a configuration file and the Experiment Management System figures out which steps need to be run and schedules them either as jobs on a cluster or runs them serially on a single machine.

Other options:

- `-no-graph`: Suppresses the display of the graph.
- `-continue RUN`: Continues the experiment `RUN`, which crashed earlier. Make sure that crashed step and its output is deleted (see more below).
- `-delete-crashed RUN`: Delete all step files and their output files for steps that have crashed in a particular `RUN`.
- `-delete-run RUN`: Delete all step files and their output files for steps for a given `RUN`, unless these steps are used by other runs.
- `-delete-version RUN`: Same as above.
- `-max-active`: Specifies the number of steps that can be run in parallel when running on a single machine (default: 2, not used when run on cluster).
- `-sleep`: Sets the number of seconds to be waited in the scheduler before the completion of tasks is checked (default: 2).
- `-ignore-time`: Changes the re-use behavior. By default files cannot be re-used when their time stamp changed (typically a tool such as the tokenizer which was changed, thus requiring re-running all tokenization steps in new experiments). With this switch, files with changed time stamp can be re-used.
- `-meta`: Allows the specification of a custom `experiment.meta` file, instead of using the one in the same directory as the `experiment.perl` script.
- `-final-step STEP`: Do not run a complete experiment, but finish at the specified `STEP`.
- `-final-out OUT`: Do not run a complete experiment, but finish when the specified output file `OUT` is created. These are the output file specifiers as used in `experiment.meta`.
- `-cluster`: Indicates that the current machine is a cluster head node. Step files are submitted as jobs to the cluster.
- `-multicore`: Indicates that the current machine is a multi-core machine. This allows for additional parallelization with the generic parallelizer setting.

The script may automatically detect if it is run on a compute cluster or a multi-core machine, if this is specified in the file `experiment.machines`, for instance:

```
cluster: townhill seville
multicore-8: tyr thor
multicore-16: loki
```

defines the machines `townhill` and `seville` as GridEngine cluster machines, `tyr` and `thor` as 8-core machines and `loki` as 16-core machines.

Typically, experiments are started with the command:

```
experiment.perl -config my-config -exec
```

Since experiments run for a long time, you may want to run this in the background and also set a nicer priority:

```
nice nohup -config my-config -exec >& OUT.[RUN] &
```

This keeps also a report (STDERR and STDOUT) on the execution in a file named, say, `OUT.1`, with the number corresponding to the run number.

The meta-information for the run is stored in the directory `steps`. Each run has a sub directory with its number (`steps/1`, `steps/2`, etc.). The sub directory `steps/0` contains step specification when `Experiment.perl` is called without the `-exec` switch.

The sub directories for each run contain the step definitions, as well as their meta-information and output. The sub directories also contain a copy of the configuration file (e.g. `steps/1/config.1`), the agenda graph (e.g. `steps/1/graph.1.{dot,ps,png}`), a file containing all expanded parameter settings (e.g. `steps/1/parameter.1`), and an empty file that is touched every minute as long as the experiment is still running (e.g. `steps/1/running.1`).

### Continuing Crashed Experiments

Steps may crash. No, steps will crash, be it because faulty settings, faulty tools, problems with the computing resources, willful interruption of an experiment, or an act of God.

The first thing to continue a crashed experiment is to detect the crashed step. This is shown either by the red node in the displayed graph or reported on the command line in the last lines before crashing; though this may not be pretty obvious, if parallel steps kept running after that. However, the automatic error detection is not perfect and a step may have failed upstream without detection causes failure further down the road.

You should have a understanding of what each step does. Then, by looking at its STDERR and STDOUT file, and the output files it should have produced, you can track down what went wrong.

Fix the problem, and delete all files associated with the failed step (e.g., `rm steps/13/TUNING_tune.13*`, `rm -r tuning/tmp.1`). To find what has been produced by the crashed step, you may need to consult where the output of this step is placed, by looking at `experiment.meta`.

You can automatically delete all crashed steps and their output files with

```
experiment.perl -delete-crashed 13 -exec
```

After removing the failed step and ensuring that the cause of the crash has been addressed, you can continue a crashed experimental run (e.g., run number 13) with:

```
experiment.perl -continue 13 -exec
```

You may want to check what will be run by excluding the `-exec` command at first. The graph indicates which steps will be re-used from the original crashed run.

If the mistake was a parameter setting, you can change that setting in the stored configuration file (e.g., `steps/1/config.1`). Take care, however, to delete all steps (and their subsequent steps) that would have been run differently with that setting.

If an experimental run crashed early, or you do not want to repeat it, it may be easier to delete the entire step directory (`rm -r steps/13`). Only do this with the latest experimental run (e.g., not when there is already a run 14), otherwise it may mess up the re-use of results.

You may also delete all output associated with a run with the command `rm -r */*.13*`. However this requires some care, so you may want to check first what you are deleting (`ls */*.13`).

### Running a Partial Experiment

By default, `experiment.perl` will run a full experiment: model building, tuning and testing. You may only want to run parts of the pipeline, for instance building a model, but not tuning and testing. You can do this by specifying either a final step or a final outcome.

If you want to terminate at a specific step

```
experiment.perl -config my-config -final-step step-name -exec
```

where `step-name` is for instance `TRAINING:create-config`, `LM:my-corpus:train`, or `TUNING:tune`.

If you want to terminate once a particular output file is generated:

```
experiment.perl -config my-config -final-out out -exec
```

Examples for `out` are `TRAINING:config`, `LM:my-corpus:lm`, or `TUNING:weight-config`. In fact, these three examples are identical to the three examples above, it is just another way to specify the final point of the pipeline.

Technically, this works by not using `REPORTING:report` as the end point of the pipeline, but the specified step.

### Removing a Run

If you want to remove all the step files and output files associated with a particular run, you can do this with, for instance:

```
experiment.perl -delete-run 13 -exec
```

If you run this without `-exec` you will see a list of files that would be deleted (but no files are actually deleted).

Steps that are used in other runs, and the output files that they produced are kept. Also, the step directory (e.g., `steps/13`) is not removed. You may remove this by hand, if there are no step files left.

### Running on a Cluster

`Experiment.perl` works with Sun GridEngine clusters. The script needs to be run on the head node and jobs are scheduled on the nodes.

There are two ways to tell `experiment.perl` that the current machine is a cluster computer. One is by using the switch `-cluster`, or by adding the machine name into `experiment.machines`.

The configuration file has a section that allows for the setting of cluster-specific settings. The setting `jobs` is used to specify into how many jobs to split the decoding during tuning and testing. For more details on this, please see `moses-parallel.pl`.

All other settings specify switches that are passed along with each submission of a job via `qsub`:

- `qsub-memory`: number of memory slots (`-pe memory NUMBER`),
- `qsub-hours`: number of hours reserved for each job (`-l h_rt=NUMBER:0:0`),
- `qsub-project`: name of the project for user accounting (`-P PROJECT`), and
- `qsub-settings`: any other setting that is passed along verbatim.

Note that the general settings can be overridden in each module definition - you may want to have different settings for different steps.

If the setting `generic-parallelizer` is set (most often it is set to the `ems` support script `$moses-script-dir/ems/support/generic-parallelizer.perl`), then a number of additional steps are parallelized. For instance, tokenization is performed by breaking up the corpus into as many parts as specified with `jobs`, jobs to process the parts are submitted in parallel to the cluster, and their output pieced together upon completion.

Be aware that there are many different ways to configure a GridEngine cluster. Not all the options described here may be available, and it may not work out of the box, due to your specific installation.

### Running on a Multi-core Machine

Using a multi-core machine means first of all that more steps can be scheduled in parallel. There is also a generic parallelizer (`generic-multicore-parallelizer.perl`) that plays the same role as the generic parallelizer for clusters.

However, decoding is not broken up into several pieces. It is more sensible to use multi-threading in the decoder<sup>31</sup>.

---

<sup>31</sup><http://www.statmt.org/moses/?n=Moses.AdvancedFeatures#multi-threaded>

## Web Interface

The introduction included some screen shots of the web interface to the Experimental Management System. You will need to have a running web server on a machine (LAMP on Linux or MAMP on Mac does the trick) that has access to the file system where your working directory is stored.

Copy or link the web directory (in `scripts/ems`) on a web server. Make sure the web server user has the right write permissions on the web interface directory.

To add your experiments to this interface, add a line to the file `/your/web/interface/dir/setup`. The format of the file is explained in the file.

### 3.5.7 Analysis

You can include additional analysis for an experimental run into the web interface by specifying the setting `analysis` in its configuration file.

```
analysis = $moses-script-dir/ems/support/analysis.perl
```

This currently reports n-gram precision and recall statistics and color-coded n-gram correctness markup for the output sentences, as in

5689 occurrences in corpus, 590 distinct translations, translation entropy: 3.35224

[#0]

Barack Obama becomes the fourth American president to receive the Nobel Peace Prize

[0.2521] Barack Obama wird der vierte amerikanische Präsident den Friedensnobelpreis erhalten .

Barack Obama erhält als vierter US @-@ Präsident den Friedensnobelpreis

The output is color-highlighted according to n-gram matches with the reference translation. The following colors are used:

- grey: word not in reference,
- light blue: word part of 1-gram match,
- blue: word part of 2-gram match,
- dark blue: word part of 3-gram match, and
- very dark blue: word part of 4-gram match.

## Segmentation

The setting `analyze-coverage` include a coverage analysis: which words and phrases in the input occur in the training data or the translation table? This is reported in color coding and in a yellow report box when moving the mouse of the word or the phrase. Also, summary statistics for how many words occur how often are given, and a report on unknown or rare words is generated.

## Coverage Analysis

The setting `analyze-coverage` include a coverage analysis: which words and phrases in the input occur in the training data or the translation table? This is reported in color coding and in a yellow report box when moving the mouse of the word or the phrase. Also, summary statistics for how many words occur how often are given, and a report on unknown or rare words is generated.

## Bilingual Concordancer

To more closely inspect where input words and phrases occur in the training corpus, the analysis tool includes a bilingual concordancer. You turn it on by adding this line to the training section of your configuration file:

```
biconcor = $moses-bin-dir/biconcor
```

During training, a suffix array of the corpus is built in the model directory. The analysis web interface accesses these binary files to quickly scan for occurrences of source words and phrases in the training corpus. For this to work, you need to include the `biconcor` binary in the web root directory.

When you click on a word or phrase, the web page is augmented with a section that shows all (or frequent word, a sample of all) occurrences of that phrase in the corpus, and how it was aligned:

The screenshot shows a web interface for a bilingual concordancer. At the top, there is a search box containing the word "occasions" and a "look up" button. Below the search box, the results are organized into several sections:

- occasions (8/12)**: This section contains eight pairs of source and target text. The source text is on the left, and the target text is on the right. The word "occasions" is highlighted in bold in both columns. For example, the first pair shows: "... , mais également à d' autres occasions , comme lors des Conseils \* ..." on the left and "... November 1999 , and also on other occasions , such as the Development Councils ..." on the right.
- opportunities (3/12)**: This section contains three pairs of source and target text. The word "opportunities" is highlighted in bold in both columns. For example, the first pair shows: "... déjà dûment compte de ces occasions dans la mesure où elles peuvent, ..." on the left and "... the real value of these opportunities which , as I said at the ..." on the right.
- SINGLETON (1/12)**: This section contains one pair of source and target text. The word "opportunities" is highlighted in bold in both columns. For example, the pair shows: "... que nous aurons de nombreuses occasions , au cours des prochains mois, d' ..." on the left and "... too that we will have many further opportunities in the coming months to ..." on the right.
- UNALIGNED (1)**: This section contains one pair of source and target text. The word "opportunities" is highlighted in blue in both columns. For example, the pair shows: "... s' appuie également sur les occasions offertes par cette époque ..." on the left and "... women , youth , and the disabled - also sees opportunity in crisis ." on the right.
- MISMATCHED (8)**: This section contains eight pairs of source and target text. The word "opportunities" is highlighted in bold in both columns. For example, the first pair shows: "... à moi @-@ même à de nombreuses occasions , lorsque nous avons débattu ..." on the left and "... Prodi and myself on the numerous occasions we have debated food safety ..." on the right.

Source occurrences (with context) are shown on the left half, the aligned target on the right.

In the main part, occurrences are grouped by different translations — also shown bold in context. Unaligned boundary words are shown in blue. The extraction heuristic extracts additional rules for these cases, but these are not listed here for clarity.

At the end, source occurrences for which no rules could be extracted are shown. This may happen because the source words are not aligned to any target words. In this case, the tool shows alignments of the previous word (purple) and following word (olive), as well as some neighboring unaligned words (again, in blue). Another reason for failure to extract rules are misalignments, when the source phrase maps to a target span which contains words that also align to outside source words (violation of the coherence constraint). These misaligned words (in source and target) are shown in red.

*Note by Dingyuan Wang* - biconcor binary should be copied to the web interface directory.

### Precision by coverage

To investigate further, if the correctness of the translation of input words depends on frequency in the corpus (and what the distribution of word frequency is), a report for precision by coverage can be turned on with the following settings:

```
report-precision-by-coverage = yes
precision-by-coverage-factor = pos
precision-by-coverage-base = $working-dir/evaluation/test.analysis.5
```

Only the first setting `report-precision-by-coverage` is needed for the report. The second setting `precision-by-coverage-factor` provides an additional breakdown for a specific input factor (in the example, the part-of-speech factor named `pos`). More on the `precision-by-coverage-base` below.

When clicking on "precision of input by coverage" on the main page, a precision by coverage graph is shown:

#### Precision of Input Words by Coverage

The graphs display what ratio of words of a specific type are translated correctly (yellow), and what ratio is deleted (blue). The extend of the boxes is scaled on the x-axis by the number of tokens of the displayed type.

By  $\log_2$ -count in the training corpus

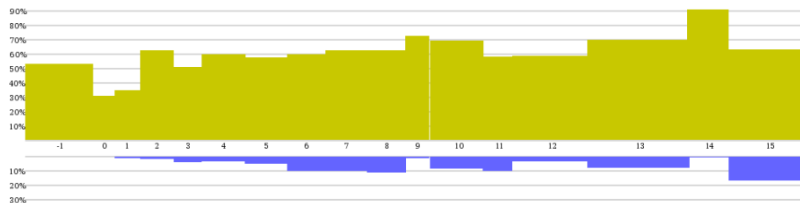

The log-coverage class is on the x-axis (-1 meaning unknown, 0 singletons, 1 words that occur twice, 2 words that occur 3-4 times, 3 words that occur 5-8 times, and so on). The scale of boxes for each class is determined by the ratio of words in the class in the test set. The precision of translations of words in a class is shown on the y-axis.

Translation of precision of input words cannot be determined in a clear cut word. Our determination relies on phrase alignment of the decoder, word alignment within phrases, and accounting for multiple occurrences of translated words in output and reference translations. Not that



the precision metric does not penalize for dropping words, so this is shown in a second graph (in blue), below the precision graph.

If you click on the graph, you will see the graph in tabular form. Following additional links allows you to see breakdowns for the actual words, and even find the sentences in which they occur.

Finally, the `precision-by-coverage-base` setting. For comparison purposes, it may be useful to base the coverage statistics on the corpus of a previous run. For instance, if you add training data, does the translation quality of the words increase? Well, a word that occurred 3 times in the small corpus, may now occur 10 times in the big corpus, hence the word is placed in a different class. To maintain the original classification of words into the log-coverage classes, you may use this setting to point to an earlier run.

*Subsection last modified on April 04, 2015, at 06:12 AM*



# 4

## User Guide

### 4.1 Support Tools

#### 4.1.1 Overview

Scripts are in the `scripts` subdirectory in the source release in the Git repository.

The following basic tools are described elsewhere:

- Moses decoder (Section 3.1)
- Training script `train-model.perl` (Section 5.3)
- Corpus preparation `clean-corpus-n.perl` (Section 5.2)
- Minimum error rate training (tuning) `mert-moses.pl` (Section 5.14)

#### 4.1.2 Converting Pharaoh configuration files to Moses configuration files

Moses is a successor to the Pharaoh decoder, so you can use the same models that work for Pharaoh and use them with Moses. The following script makes the necessary changes to the configuration file:

```
exodus.perl < pharaoh.ini > moses.ini
```

#### 4.1.3 Moses decoder in parallel

Since decoding large amounts of text takes a long time, you may want to split up the text into blocks of a few hundred sentences (or less), and distribute the task across a Sun GridEngine cluster. This is supported by the script `moses-parallel.pl`, which is run as follows:

```
moses-parallel.pl -decoder decoder -config cfgfile -i input -jobs N [options]
```

Use absolute paths for your parameters (decoder, configuration file, models, etc.).

- `decoder` is the file location of the binary of Moses used for decoding
- `cfgfile` is the configuration file of the decoder
- `input` is the file to translate
- `N` is the number of processors you require
- `options` are used to overwrite parameters provided in `cfgfile`  
Among them, overwrite the following two parameters for nbest generation (NOTE: they differ from standard Moses)
  - `-n-best-file` output file for nbest list
  - `-n-best-size` size of nbest list

#### 4.1.4 Filtering phrase tables for Moses

Phrase tables easily get too big, but for the translation of a specific set of text only a fraction of the table is needed. So, you may want to filter the translation table, and this is possible with the script:

```
filter-model-given-input.pl filter-dir config input-file
```

This creates a filtered translation table with new configuration file in the directory `filter-dir` from the model specified with the configuration file `config` (typically named `moses.ini`), given the (tokenized) input from the file `input-file`.

In the advanced feature section, you find the additional option of binarizing translation and reordering table, which allows these models to be kept on disk and queried by the decoder. If you want to both filter and binarize these tables, you can use the script:

```
filter-model-given-input.pl filter-dir config input-file -Binarizer binarizer
```

The additional binarizer option points to the appropriate version of `processPhraseTable`.

#### 4.1.5 Reducing and Extending the Number of Factors

Instead of the two following scripts, this one does both at the same time, and is better suited for our directory structure and factor naming conventions:

```
reduce_combine.pl \  
czeng05.cs \  
0,2 pos lcstem4 \  
> czeng05_restricted_to_0,2_and_with_pos_and_lcstem4_added
```

### 4.1.6 Scoring translations with BLEU

A simple BLEU scoring tool is the script `multi-bleu.perl`:

```
multi-bleu.perl reference < mt-output
```

Reference file and system output have to be sentence-aligned (line X in the reference file corresponds to line X in the system output). If multiple reference translations exist, these have to be stored in separate files and named `reference0`, `reference1`, `reference2`, etc. All the texts need to be tokenized.

A popular script to score translations with BLEU is the NIST `mteval` script<sup>1</sup>. It requires that text is wrapped into a SGML format. This format is used for instance by the NIST evaluation<sup>2</sup> and the WMT Shared Task evaluations<sup>3</sup>. See the latter for more details on using this script.

### 4.1.7 Missing and Extra N-Grams

Missing n-grams are those that all reference translations wanted but MT system did not produce. Extra n-grams are those that the MT system produced but none of the references approved.

```
missing_and_extra_ngrams.pl hypothesis reference1 reference2 ...
```

### 4.1.8 Making a Full Local Clone of Moses Model + ini File

Assume you have a `moses.ini` file already and want to run an experiment with it. Some months from now, you might still want to know what exactly did the model (incl. all the tables) look like, but people tend to move files around or just delete them.

To solve this problem, create a blank directory, go in there and run:

```
clone_moses_model.pl ../path/to/moses.ini
```

`clone_moses_model.pl` will make a copy of the `moses.ini` file and local symlinks (and if possible also hardlinks, in case someone deleted the original file) to all the tables and language models needed.

It will be now safe to run `moses` locally in the fresh directory.

<sup>1</sup><http://www.nist.gov/speech/tests/mt/2008/scoring.html>

<sup>2</sup><http://www.nist.gov/speech/tests/mt/2009/>

<sup>3</sup><http://www.statmt.org/wmt09/translation-task.html>

### 4.1.9 Absolutizing Paths in moses.ini

Run:

```
absolutize_moses_model.pl ../path/to/moses.ini > moses.abs.ini
```

to build an ini file where all paths to model parts are absolute. (Also checks the existence of the files.)

### 4.1.10 Printing Statistics about Model Components

The script

```
analyse_moses_model.pl moses.ini
```

Prints basic statistics about all components mentioned in the moses.ini. This can be useful to set the order of mapping steps to avoid explosion of translation options or just to check that the model components are as big/detailed as we expect.

Sample output lists information about a model with 2 translation and 1 generation step. The three language models over three factors used and their n-gram counts (after discounting) are listed, too.

```
Translation 0 -> 1 (/fullpath/to/phrase-table.0-1.gz):
743193      phrases total
1.20  phrases per source phrase
Translation 1 -> 2 (/fullpath/to/phrase-table.1-2.gz):
558046      phrases total
2.75  phrases per source phrase
Generation 1,2 -> 0 (/fullpath/to/generation.1,2-0.gz):
1.04  outputs per source token
Language model over 0 (/fullpath/to/lm.1.lm):
1      2      3
49469 245583 27497
Language model over 1 (/fullpath/to/lm.2.lm):
1      2      3
25459 199852 32605
Language model over 2 (/fullpath/to/lm.3.lm):
1      2      3      4      5      6      7
709   20946 39885 45753 27964 12962 7524
```

### 4.1.11 Recaser

Often, we train machine translation systems on lowercased data. If we want to present the output to a user, we need to re-case (or re-capitalize) the output. Moses provides a simple tool to recase data, which essentially runs Moses without reordering, using a word-to-word translation model and a cased language model.

The recaser requires a model (i.e., the word mapping model and language model mentioned above), which is trained with the command:

```
train-recaser.perl --dir MODEL --corpus CASED [--train-script TRAIN]
```

The script expects a cased (but tokenized) training corpus in the file `CASED`, and creates a recasing model in the directory `MODEL`. KenLM's `Implz` is used to train language models by default; pass `--lm` to change the toolkit.

To recase output from the Moses decoder, you run the command

```
recase.perl --in IN --model MODEL/moses.ini --moses MOSES [--lang LANGUAGE] [--headline SGML] > OUT
```

The input is in file `IN`, the output in file `OUT`. You also need to specify a recasing model `MODEL`. Since headlines are capitalized different from regular text, you may want to provide an SGML file that contains information about headline. This file uses the NIST format, and may be identical to source test sets provided by the NIST or other evaluation campaigns. A language `LANGUAGE` may also be specified, but only English (`en`) is currently supported.

By default, EMS trains a truecaser (see below). To use a recaser, you have to make the following changes:

- Comment out `output-truecaser` and `detruecaser` and add instead `output-lowercaser` and `EVALUATION:recaser`.
- Add `IGNORE` to the `[TRUECASING]` section, and remove it from the `[RECASING]` section
- Specify in the `[RECASING]` section, which training corpus should be used for the recaser. This is typically the target side of the parallel corpus or a large language model corpus. You can directly link to a corpus already specified to the config file, e.g., `tokenized = [LM:europarl:tokenized-corpus]`

### 4.1.12 Truecaser

Instead of lowercasing all training and test data, we may also want to keep words in their natural case, and only change the words at the beginning of their sentence to their most frequent form. This is what we mean by truecasing. Again, this requires first the training of a truecasing model, which is a list of words and the frequency of their different forms.

```
train-truecaser.perl --model MODEL --corpus CASED
```

The model is trained from the cased (but tokenized) training corpus CASED and stored in the file MODEL.

Input to the decoder has to be truecased with the command

```
truecase.perl --model MODEL < IN > OUT
```

Output from the decoder has to be restored into regular case. This simply uppercases words at the beginning of sentences:

```
detruecase.perl < in > out [--headline SGML]
```

An SGML file with headline information may be provided, as done with the recaser.

#### 4.1.13 Searchgraph to DOT

This small tool converts Moses searchgraph (`-output-search-graph FILE` option) to dot format. The dot format can be rendered using the graphviz<sup>4</sup> tool `dot`.

```
moses ... --output-search-graph temp.graph -s 3
# we suggest to use a very limited stack size, -s 3
sg2dot.perl [--organize-to-stacks] < temp.graph > temp.dot
dot -Tps temp.dot > temp.ps
```

Using `--organize-to-stacks` makes nodes in the same stack appear in the same column (this slows down the rendering, off by default).

Caution: the input must contain the searchgraph of one sentence only.

---

<sup>4</sup><http://www.graphviz.org/>



#### 4.1.14 Threshold Pruning of Phrase Table

The phrase table trained by Moses contains by default all phrase pairs encountered in the parallel training corpus. This often includes 100,000 different translations for the word "the" or the comma ",". These may clog up various processing steps down the road, so it is helpful to prune the phrase table to the reasonable choices.

Threshold pruning is currently implemented at two different stages: You may filter the entire phrase table file, or use threshold pruning as an additional filtering criterion when filtering the phrase table for a given test set. In either case, phrase pairs are thrown out when their phrase translation probability  $p(e|f)$  falls below a specified threshold. A safe number for this threshold may be 0.0001, in the sense that it hardly changes any phrase translation while ridding the table of a lot of junk.

##### Pruning the full phrase table file

The script `scripts/training/threshold-filter.perl` operates on any phrase table file:

```
cat PHRASE_TABLE | \  
threshold-filter.perl 0.0001 > PHRASE_TABLE.reduced
```

If the phrase table is zipped, then:

```
zcat PHRASE_TABLE.gz | \  
threshold-filter.perl 0.0001 | \  
gzip - > PHRASE_TABLE.reduced.gz
```

While this often does not remove much of the phrase table (which contains to a large part singleton phrase pairs with  $p(e|f)=1$ ), it may nevertheless be helpful to also reduce the reordering model. This can be done with a second script:

```
cat REORDERING_TABLE | \  
remove-orphan-phrase-pairs-from-reordering-table.perl PHRASE_TABLE \  
> REORDERING_TABLE.pruned
```

Again, this also works for zipped files:

```
zcat REORDERING_TABLE.gz | \  
remove-orphan-phrase-pairs-from-reordering-table.perl PHRASE_TABLE | \  
gzip - > REORDERING_TABLE.pruned.gz
```

### Pruning during test/tuning set filtering

In the typical experimental setup, the phrase table is filtered for a tuning or test set using the script. During this process, we can also remove low-probability phrase pairs. This can be done simply by adding the switch `-MinScore`, which takes a specification of the following form:

```
filter-model-given-input.pl [...] \
-MinScore FIELD1:THRESHOLD2[,FIELD2:THRESHOLD2[,FIELD3:THRESHOLD3]]
```

where `FIELDn` is the position of the score (typically 2 for the direct phrase probability  $p(e|f)$ , or 0 for the indirect phrase probability  $p(f|e)$ ) and `THRESHOLD` the maximum probability allowed.

*Subsection last modified on February 06, 2016, at 10:11 PM*

## 4.2 External Tools

A very active community is engaged in statistical machine translation research, which has produced a number of tools that may be useful for training a Moses system. Also, the more linguistically motivated models (factored model, syntax model) require tools to the linguistic annotation of corpora.

In this section, we list some useful tools. If you know (or are the developer of) anything we missed here, please contact us and we can add it to the list. For more comprehensive listings of MT tools, refer to the following pages:

- List of Free/Open-source MT Tools<sup>5</sup>, maintained by Mikel Forcada.
- TAUS Tracker<sup>6</sup>, a comprehensive list of Translation and Language Technology tools maintained by TAUS.

### 4.2.1 Word Alignment Tools

#### Berkeley Word Aligner

The BerkeleyAligner<sup>7</sup> (available at Sourceforge<sup>8</sup>) is a word alignment software package that implements recent innovations in unsupervised word alignment. It is implemented in Java and distributed in compiled format.

Installation:

---

<sup>5</sup><http://www.fosmt.org>

<sup>6</sup><http://www.taustracker.com/>

<sup>7</sup><http://nlp.cs.berkeley.edu/Main.html#WordAligner>

<sup>8</sup><http://code.google.com/p/berkeleyaligner/>

```
mkdir /my/installation/dir
cd /my/installation/dir
wget http://berkeleyaligner.googlecode.com/files/berkeleyaligner_unsupervised-2.1.tar.gz
tar xzf berkeleyaligner_unsupervised-2.1.tar.gz
```

Test:

```
cd berkeleyaligner
chmod +x align
./align example.conf
```

### Multi-threaded GIZA++

MGIZA<sup>9</sup> was developed by Qin Gao. It is an implementation of the popular GIZA++ word alignment toolkit to run multi-threaded on multi-core machines. Check the web site for more recent versions.

Installation:

```
git clone https://github.com/moses-smt/mgiza.git
cd mgiza/mgizapp
cmake .
make
make install
```

Compiling MGIZA requires the Boost library. If your Boost library are in non-system directory, use the script

```
manual-compile/compile.sh
```

to compile MGIZA.

The MGIZA binary and the script `merge_alignment.py` need to be copied in you binary directory that Moses will look up for word alignment tools. This is the exact command I use to copy MGIZA to it final destination:

---

<sup>9</sup><http://www.kyloo.net/software/doku.php>

```
export BINDIR=~/.workspace/bin/training-tools
cp bin/* $BINDIR/mgizapp
cp scripts/merge_alignment.py $BINDIR
```

MGIZA works with the training script `train-model.perl`. You indicate its use (opposed to regular GIZA++) with the switch `-mgiza`. The switch `-mgiza-cpus NUMBER` allows you to specify the number of CPUs.

### Dyer et al.'s Fast Align

The Fast Align<sup>10</sup> is a comparable fast unsupervised word aligner that nevertheless gives comparable results to GIZA++. Its details are described in a NAACL 2013 paper<sup>11</sup>

Installation:

```
mkdir /my/installation/dir
cd /my/installation/dir
git clone https://github.com/clab/fast_align.git
cd fast_align
make
```

### Anymalign

Anymalign<sup>12</sup> is a multilingual sub-sentential aligner. It can extract lexical equivalences from sentence-aligned parallel corpora. Its main advantage over other similar tools is that it can align any number of languages simultaneously. The details are describe in Lardilleux and Lepage (2009)<sup>13</sup>. To understand the algorithm, a pure python implementation can be found in `minimalign.py`<sup>14</sup> but it is advisable use the main implementation for realistic usage.

Installation:

```
mkdir /your/installation/dir
cd /your/installation/dir
wget https://anymalign.limsi.fr/latest/anymalign2.5.zip
unzip anymalign2.5.zip
```

<sup>10</sup>[https://github.com/clab/fast\\_align/blob/master/README.md](https://github.com/clab/fast_align/blob/master/README.md)

<sup>11</sup>[http://www.ark.cs.cmu.edu/cdyer/fast\\_valign.pdf](http://www.ark.cs.cmu.edu/cdyer/fast_valign.pdf)

<sup>12</sup><https://anymalign.limsi.fr/>

<sup>13</sup><http://www.aclweb.org/anthology/R09-1040>

<sup>14</sup><https://anymalign.limsi.fr/minimalign.py>

### 4.2.2 Evaluation Metrics

#### Translation Error Rate (TER)

Translation Error Rate<sup>15</sup> is an error metric for machine translation that measures the number of edits required to change a system output into one of the references. It is implemented in Java.

Installation:

```
mkdir /my/installation/dir
cd /my/installation/dir
wget http://www.cs.umd.edu/~snoover/tercom/tercom-0.7.25.tgz
tar xzf tercom-0.7.25.tgz
```

#### METEOR

METEOR<sup>16</sup> is a metric that includes stemmed and synonym matches when measuring the similarity between system output and human reference translations.

Installation:

```
mkdir /my/installation/dir
cd /my/installation/dir
wget http://www.cs.cmu.edu/~alavie/METEOR/install-meteor-1.0.sh
sh install-meteor-1.0.sh
```

#### RIBES

RIBES<sup>17</sup> is a word rank-based metric that compares the ratio of contiguous and dis-contiguous word pairs between the system output and human translations.

Installation:

```
# First download from http://www.kecl.ntt.co.jp/icl/lirg/ribes/
# (need to accept to agree to the free license, so no direct URL)
tar -xvzf RIBES-1.03.1.tar.gz
cd RIBES-1.03.1/
python RIBES.py --help
```

<sup>15</sup><http://www.cs.umd.edu/~snoover/tercom/>

<sup>16</sup><http://www.cs.cmu.edu/~alavie/METEOR/>

<sup>17</sup><http://www.kecl.ntt.co.jp/icl/lirg/ribes/>

### 4.2.3 Part-of-Speech Taggers

#### MXPOST (English)

MXPOST was developed by Adwait Ratnaparkhi as part of his PhD thesis. It is a Java implementation of a maximum entropy model and distributed as compiled code. It can be trained for any language pair for which annotated POS data exists.

Installation:

```
mkdir /your/installation/dir
cd /your/installation/dir
wget ftp://ftp.cis.upenn.edu/pub/adwait/jmx/jmx.tar.gz
tar xzf jmx.tar.gz
echo '#!/bin/ksh' > mxpost
echo 'export CLASSPATH=/your/installation/dir/mxpost.jar' >> mxpost
echo 'java -mx30m tagger.TestTagger /your/installation/dir/tagger.project' >> mxpost
```

Test:

```
echo 'This is a test .' | ./mxpost
```

The script `script/training/wrappers/make-factor-en-pos.mxpost.perl` is a wrapper script to create factors for a factored translation model. You have to adapt the definition of `$MXPOST` to point to your installation directory.

#### TreeTagger (English, French, Spanish, German, Italian, Dutch, Bulgarian, Greek)

TreeTagger<sup>18</sup> is a tool for annotating text with part-of-speech and lemma information.

Installation (Linux, check web site for other platforms):

```
mkdir /my/installation/dir
cd /my/installation/dir
wget ftp://ftp.ims.uni-stuttgart.de/pub/corpora/tree-tagger-linux-3.2.tar.gz
wget ftp://ftp.ims.uni-stuttgart.de/pub/corpora/tagger-scripts.tar.gz
wget ftp://ftp.ims.uni-stuttgart.de/pub/corpora/install-tagger.sh
wget ftp://ftp.ims.uni-stuttgart.de/pub/corpora/english-par-linux-3.1.bin.gz
wget ftp://ftp.ims.uni-stuttgart.de/pub/corpora/french-par-linux-3.2-utf8.bin.gz
```

<sup>18</sup><http://www.ims.uni-stuttgart.de/projekte/corplex/TreeTagger/>

```
wget ftp://ftp.ims.uni-stuttgart.de/pub/corpora/spanish-par-linux-3.1.bin.gz
wget ftp://ftp.ims.uni-stuttgart.de/pub/corpora/german-par-linux-3.2.bin.gz
wget ftp://ftp.ims.uni-stuttgart.de/pub/corpora/italian-par-linux-3.2-utf8.bin.gz
wget ftp://ftp.ims.uni-stuttgart.de/pub/corpora/dutch-par-linux-3.1.bin.gz
wget ftp://ftp.ims.uni-stuttgart.de/pub/corpora/bulgarian-par-linux-3.1.bin.gz
wget ftp://ftp.ims.uni-stuttgart.de/pub/corpora/greek-par-linux-3.2.bin.gz
sh install-tagger.sh
```

The wrapper script `scripts/training/wrapper/make-pos.tree-tagger.perl` creates part-of-speech factors using TreeTagger in the format expected by Moses. The command has the required parameters `-tree-tagger DIR` to specify the location of your installation and `-l LANGUAGE` to specify the two-letter code for the language (`de`, `fr`, ...). Optional parameters are `-basic` to output only basic part-of-speech tags (`VER` instead of `VER:simp` -- not available for all languages), and `--stem` to output stems instead of part-of-speech tags.

Treetagger can also shallow parse the sentence, labelling it with chunk tags. See their website<sup>19</sup> for details.

### FreeLing

FreeLing<sup>20</sup> is a set of a tokenizers, morphological analyzers, syntactic parsers. and other language tools for Asturian, Catalan, English, Galician, Italian, Portuguese, Russian, Spanish, and Welsh.

#### 4.2.4 Syntactic Parsers

##### Collins (English)

Michael Collins<sup>21</sup> developed the first statistical parser as part of his PhD thesis. It is implemented in C.

Installation:

```
mkdir /your/installation/dir
cd /your/installation/dir
wget http://people.csail.mit.edu/mcollins/PARSER.tar.gz
tar xzf PARSER.tar.gz
cd COLLINS-PARSER/code
make
```

Collins parser also requires the installation of MXPOST (Section 4.2.3). A wrapper file to generate parse trees in the format required to train syntax models with Moses is provided in `scripts/training/wrapper/parse-en-collins.perl`.

<sup>19</sup><http://www.ims.uni-stuttgart.de/projekte/complex/TreeTagger/DecisionTreeTagger.html>

<sup>20</sup><http://nlp.lsi.upc.edu/freeling/>

<sup>21</sup><http://people.csail.mit.edu/mcollins/>

### BitPar (German, English)

Helmut Schmid developed BitPar<sup>22</sup>, a parser for highly ambiguous probabilistic context-free grammars (such as treebank grammars). BitPar uses bit-vector operations to speed up the basic parsing operations by parallelization. It is implemented in C and distributed as compiled code.

Installation:

```
mkdir /your/installation/dir
cd /your/installation/dir
wget ftp://ftp.ims.uni-stuttgart.de/pub/corpora/BitPar/BitPar.tar.gz
tar xzf BitPar.tar.gz
cd BitPar/src
make
cd ../../
```

You will also need the parsing model for German which was trained on the Tiger treebank:

```
wget ftp://ftp.ims.uni-stuttgart.de/pub/corpora/BitPar/GermanParser.tar.gz
tar xzf GermanParser.tar.gz
cd GermanParser/src
make
cd ../../
```

There is also an English parsing model.

### LoPar (German)

LoPar<sup>23</sup> is an implementation of a parser for head-lexicalized probabilistic context-free grammars, which can be also used for morphological analysis. The program is distributed without source code.

Installation:

```
mkdir /my/installation/dir
cd /my/installation/dir
wget ftp://ftp.ims.uni-stuttgart.de/pub/corpora/LoPar/lopar-3.0.linux.tar.gz
tar xzf lopar-3.0.linux.tar.gz
cd LoPar-3.0
```

<sup>22</sup><http://www.cis.uni-muenchen.de/~schmid/tools/BitPar/>

<sup>23</sup><http://www.ims.uni-stuttgart.de/tcl/SOFTWARE/LoPar.html>



### **Berkeley Parser**

The Berkeley is a phrase structure grammar parser implemented in Java and distributed open source. Models are provided for English, Bugarian, Arabic, Chinese, French, German.

<http://code.google.com/p/berkeleyparser/>

## **4.2.5 Other Open Source Machine Translation Systems**

### **Joshua**

Joshua<sup>24</sup> is a machine translation decoder for hierarchical models. Joshua development is centered at the Center for Language and Speech Processing at the Johns Hopkins University in Baltimore, Maryland. It is implemented in Java.

### **cdec**

Cdec<sup>25</sup> is a decoder, aligner, and learning framework for statistical machine translation and other structured prediction models written by Chris Dyer in the University of Maryland Department of Linguistics. It is written in C++.

### **Apertium**

Apertium<sup>26</sup> is an open source rule-based machine translation (RBMT) system, maintained principally by the University of Alicante and Prompsit Engineering.

### **Docent**

Docent<sup>27</sup> is a decoder for phrase-based SMT that treats complete documents, rather than single sentences, as translation units and permits the inclusion of features with cross-sentence dependencies. It is developed by Christian Hardmeier and implemented in C++

### **Phrasal**

Phrase-based SMT toolkit written in Java. <http://www-nlp.stanford.edu/wiki/Software/Phrasal2>

---

<sup>24</sup><http://joshua.sourceforge.net/Joshua/Welcome.html>

<sup>25</sup><http://cdec-decoder.org/>

<sup>26</sup><http://www.apertium.org/>

<sup>27</sup><https://github.com/chardmeier/docent/wiki>

## 4.2.6 Other Translation Tools

### COSTA MT Evaluation Tool

COSTA MT Evaluation Tool<sup>28</sup> is an open-source Java program that can be used to evaluate manually the quality of the MT output. It is simple in use, designed to allow MT potential users and developers to analyse their engines using a friendly environment. It enables the ranking of the quality of MT output segment-by-segment for a particular language pair.

### Appraise

Appraise<sup>29</sup> is an open-source tool for manual evaluation of Machine Translation output. Appraise allows to collect human judgments on translation output, implementing annotation tasks such as translation quality checking, ranking of translations, error classification, and manual post-editing. It is used in the ACL WMT evaluation campaign<sup>30</sup>.

### Indic NLP Library

Python based libraries for common text processing and Natural Language Processing in Indian languages. Indian languages share a lot of similarity in terms of script, phonology, language syntax, etc. and this library is an attempt to provide a general solution to very commonly required toolsets for Indian language text.

The library provides the following functionalities:

```
Text Normalization
Transliteration
Tokenization
Morphological Analysis
```

[https://github.com/anoopkunchukuttan/indic\\_nlp\\_library](https://github.com/anoopkunchukuttan/indic_nlp_library)

*Subsection last modified on January 26, 2016, at 08:04 PM*

---

<sup>28</sup><https://code.google.com/p/costa-mt-evaluation-tool/>

<sup>29</sup><https://github.com/cfedermann/Appraise>

<sup>30</sup><http://www.statmt.org/wmt13/>

## 4.3 User Documentation

The basic features of the decoder are explained in the Tutorial (Section 3.1) and Training sections. But to get good results from Moses you probably need to use some of the features described in this page.

**Advanced Models (Section 4.4)** A basic SMT system contains a language model and a translation model, however there are several ways to extend this (and potentially improve translation) by adding extra models. These may improve the modelling of reordering, for example, or capture similarities between related words.

**Efficient Phrase and Rule Storage (Section 4.5)** To build a state-of-the-art translation system, Moses often requires huge phrase-pair or rule tables. The efficient storage and access of these tables requires specialised data structures and this page describes several different implementations.

**Search (Section 4.6)** Given an MT model and a source sentence, the problem of finding the best translation is an intractable search problem. Moses implements several methods for taming this intractability.

**Unknown Words (Section 4.7)** No matter how big your training data is, there will always be OOVs (out-of-vocabulary words) in the text you wish to translate. One approach may be to transliterate - if your source and target languages have different character sets.

**Hybrid Translation (Section 4.8)** Sometimes you need rules! If you want to add explicit knowledge to Moses models, for example for translating terminology or numbers, dates etc., Moses has a few ways of making this possible.

**Moses as a Service (Section 4.9)** Moses includes a basic server which can deliver translations over xml-rpc.

**Incremental Training (Section 4.10)** The traditional Moses pipeline is a sequence of batch processes, but what if you want to add extra training data to a running system? Storing the phrase table in a suffix array makes this possible.

**Domain Adaptation (Section 4.11)** When the training data differs in a systematic way from the test data you have a domain problem. Several techniques have been proposed in the literature have been proposed and Moses includes implementations of many of them.

**Constrained Decoding (Section 4.12)** In some applications, you know that translation but you need to know how the model derived it.

**Cache-based Models (Section 4.13)** These can be a useful way for the document context to influence the translation.

**Sparse features (Section 4.16)** Feature functions that produce many features, for instance lexicalized features

**Support Tools (Section 4.1)** Various tools to manipulate models and configuration files.

**External Tools (Section 4.2)** Linguistic tools, word aligners, evaluation metrics and frameworks, other open source machine translation systems.

**Web Translation (Section 4.17)** Web service software to translate web pages and text on demand.

**Pipeline Creation Language (Section 4.14)** A generic mechanism for managing pipelines of software components, such as Moses training.

**Obsolete Features (Section 4.15)** Things that have been removed, but documentation is preserved for posterity.

*Subsection last modified on December 23, 2015, at 05:43 PM*

## 4.4 Advanced Models

### 4.4.1 Lexicalized Reordering Models

The default standard model that for phrase-based statistical machine translation is only conditioned on movement distance and nothing else. However, some phrases are reordered more frequently than others. A French adjective like *extérieur* typically gets switched with the preceding noun, when translated into English.

Hence, we want to consider a **lexicalized reordering model** that conditions reordering on the actual phrases. One concern, of course, is the problem of sparse data. A particular phrase pair may occur only a few times in the training data, making it hard to estimate reliable probability distributions from these statistics.

Therefore, in the lexicalized reordering model we present here, we only consider three reordering types: (m) monotone order, (s) switch with previous phrase, or (d) discontinuous. See below for an illustration of these three different types of **orientation** of a phrase.

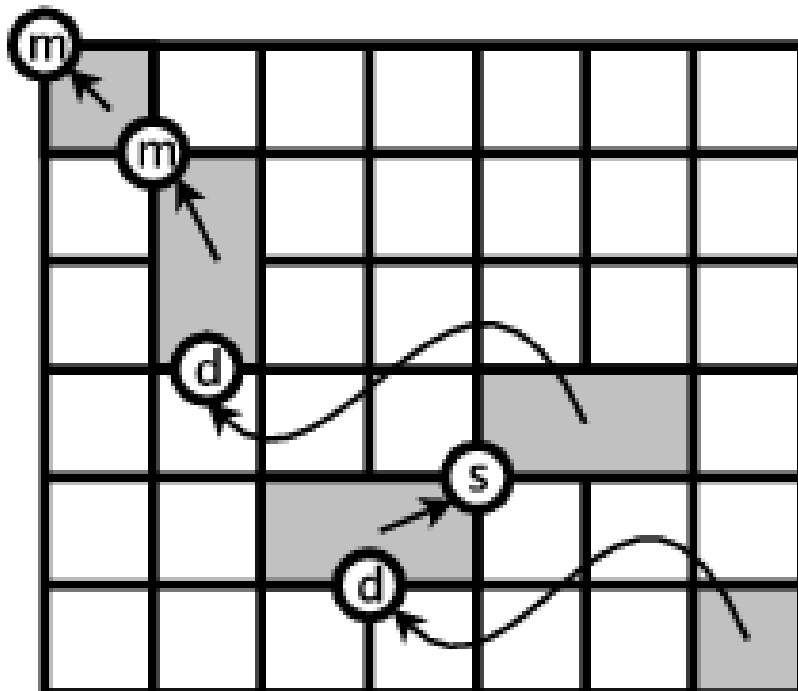

To put it more formally, we want to introduce a reordering model  $p_o$  that predicts an orientation type  $\{m,s,d\}$  given the phrase pair currently used in translation:

$orientation \in \{m, s, d\}$

$p_o(orientation|f,e)$

How can we learn such a probability distribution from the data? Again, we go back to the word alignment that was the basis for our phrase table. When we extract each phrase pair, we can also extract its orientation type in that specific occurrence.

Looking at the word alignment matrix, we note for each extracted phrase pair its corresponding orientation type. The orientation type can be detected, if we check for a word alignment point to the top left or to the top right of the extracted phrase pair. An alignment point to the top left signifies that the preceding English word is aligned to the preceding Foreign word. An alignment point to the top right indicates that the preceding English word is aligned to the following french word. See below for an illustration.

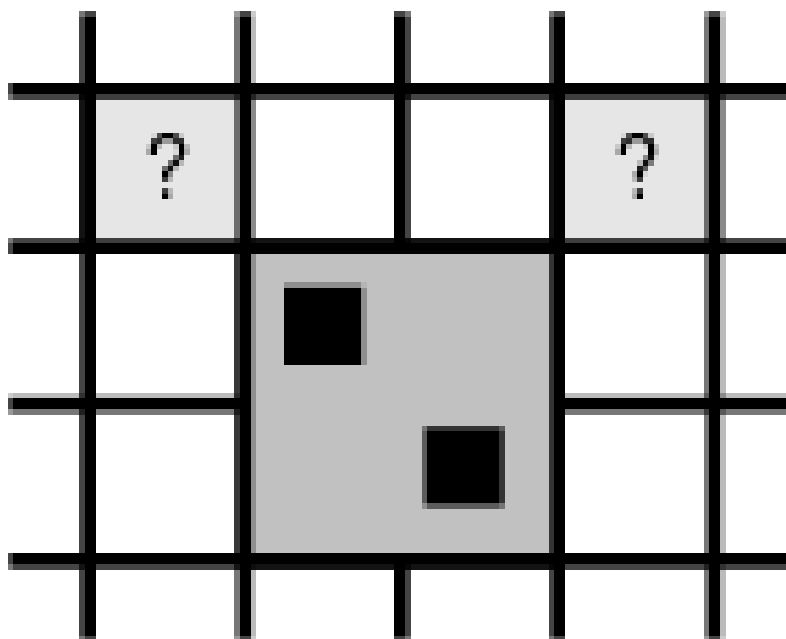

The orientation type is defined as follows:

- **monotone**: if a word alignment point to the top left exists, we have evidence for monotone orientation.
- **swap**: if a word alignment point to the top right exists, we have evidence for a swap with the previous phrase.
- **discontinuous**: if neither a word alignment point to top left nor to the top right exists, we have neither monotone order nor a swap, and hence evidence for discontinuous orientation.

We count how often each extracted phrase pair is found with each of the three orientation types. The probability distribution  $p_o$  is then estimated based on these counts using the maximum likelihood principle:

$$p_o(orientation|f,e) = \text{count}(orientation,e,f) / \sum_o \text{count}(o,e,f)$$

Given the sparse statistics of the orientation types, we may want to smooth the counts with the unconditioned maximum-likelihood probability distribution with some factor  $\sigma$ :

$$p_o(\text{orientation}) = \sum_f \sum_e \text{count}(\text{orientation}, e, f) / \sum_o \sum_f \sum_e \text{count}(o, e, f)$$

$$p_o(\text{orientation} | f, e) = (\sigma p(\text{orientation}) + \text{count}(\text{orientation}, e, f)) / (\sigma + \sum_o \text{count}(o, e, f))$$

There are a number of variations of this lexicalized reordering model based on orientation types:

- **bidirectional**: Certain phrases may not only flag, if they themselves are moved out of order, but also if subsequent phrases are reordered. A lexicalized reordering model for this decision could be learned in addition, using the same method.
- **f and e**: Out of sparse data concerns, we may want to condition the probability distribution only on the foreign phrase (**f**) or the English phrase (**e**).
- **monotonicity**: To further reduce the complexity of the model, we might merge the orientation types swap and discontinuous, leaving a binary decision about the phrase order.

These variations have shown to be occasionally beneficial for certain training corpus sizes and language pairs. Moses allows the arbitrary combination of these decisions to define the reordering model type (e.g. *bidirectional-monotonicity-f*). See more on training these models in the training section of this manual.

### Enhanced orientation detection

As explained above, statistics about the orientation of each phrase can be collected by looking at the word alignment matrix, in particular by checking the presence of a word at the top left and right corners. This simple approach is capable of detecting a swap with a previous phrase that contains a word exactly aligned on the top right corner, see case (a) in the figure below. However, this approach cannot detect a swap with a phrase that does not contain a word with such an alignment, like the case (b). A variation to the way phrase orientation statistics are collected is the so-called **phrase-based orientation model** by Tillmann (2004)<sup>31</sup>, which uses phrases both at training and decoding time. With the phrase-based orientation model, the case (b) is properly detected and counted during training as a swap. A further improvement of this method is the **hierarchical orientation model** by Galley and Manning (2008)<sup>32</sup>, which is able to detect swaps or monotone arrangements between blocks even larger than the length limit imposed to phrases during training, and larger than the phrases actually used during decoding. For instance, it can detect at decoding time the swap of blocks in the case (c) shown below.

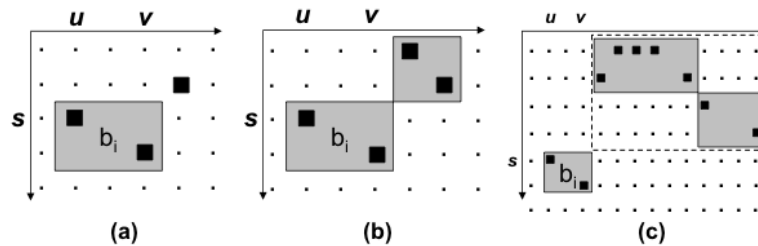

<sup>31</sup><http://www.aclweb.org/anthology-new/N/N04/N04-4026.pdf>

<sup>32</sup><http://www.aclweb.org/anthology/D/D08/D08-1089.pdf>

(Figure from Galley and Manning, 2008)

Empirically, the enhanced orientation methods should be used with language pairs involving significant word re-ordering.

#### 4.4.2 Operation Sequence Model (OSM)

The Operation Sequence Model as described in Durrani et al. (2011)<sup>33</sup> and Durrani et al. (2013)<sup>34</sup> has been integrated into Moses.

##### What is OSM?

OSM is an N-gram-based translation and reordering model that represents aligned bilingual corpus as a sequence of operations and learns a Markov model over the resultant sequences. Possible operations are (i) generation of a sequence of source and target words (ii) insertion of gaps as explicit target positions for reordering operations, and (iii) forward and backward jump operations which do the actual reordering. The probability of a sequence of operations is defined according to an N-gram model, i.e., the probability of an operation depends on the n-1 preceding operations. Let  $O = o_1, \dots, o_N$  be a sequence of operations as hypothesized by the translator to generate a word-aligned bilingual sentence pair  $\langle F;E;A \rangle$ ; the model is then defined as:

$$p_{\text{osm}}(E,E,A) = p(o_1, \dots, o_N) = \prod_i p(o_i | o_{i-n+1} \dots o_{i-1})$$

The OSM model addresses several drawbacks of the phrase-based translation and lexicalized reordering models: i) it considers source and target contextual information across phrasal boundaries and does not make independence assumption, ii) it is based on minimal translation units therefore does not have the problem of spurious phrasal segmentation, iii) it consider much richer conditioning than the lexicalized reordering model which only learns orientation of a phrase w.r.t previous phrase (or block of phrases) ignoring how previous words were translated and reordered. The OSM model conditions translation and reordering decisions on 'n' previous translation and reordering decisions which can span across phrasal boundaries.

A list of operations is given below:

**Generate (X,Y):** X and Y are source and target cepts in an MTU (minimal translation unit). This operation causes the words in Y and the first word in X to be added to the target and source strings respectively, that were generated so far. Subsequent words in X are added to a queue to be generated later.

**Continue Source Cept:** The source words added to the queue by the *Generate (X,Y)* operation are generated by the *Continue Source Cept operation*. Each Continue Source Cept operation removes one German word from the queue and copies it to the source string.

**Generate Source Only (X):** The words in X are added at the current position in the source string. This operation is used to generate an target word with no corresponding target word.

**Generate Target Only (Y):** The words in Y are added at the current position in the target string. This operation is used to generate an target word with no corresponding source word.

<sup>33</sup><http://aclweb.org/anthology/P/P11/P11-1105.pdf>

<sup>34</sup><http://aclweb.org/anthology/P/P13/P13-2071.pdf>

**Generate Identical:** The same word is added at the current position in both the source and target strings. The *Generate Identical* operation is used during decoding for the translation of unknown words.

**Insert Gap:** This operation inserts a gap which acts as a placeholder for the skipped words. There can be more than one open gap at a time.

**Jump Back (W):** This operation lets the translator jump back to an open gap. It takes a parameter *W* specifying which gap to jump to. *W*=1 for the gap closest to the right most source word covered, *W*=2 for the second most closest and so on.

**Jump Forward:** This operation makes the translator jump to the right-most source word so far covered. It is performed when the next source word to be generated is at the right of the source word generated and does not follow immediately

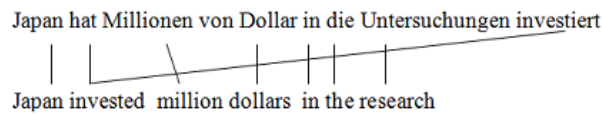

The example shown in figure is deterministically converted to the following operation sequence:

*Generate Identical* -- *Generate (hat investiert, invested)* -- *Insert Gap* -- *Continue Source Cept* -- *Jump Back (1)* -- *Generate (Millionen, million)* -- *Generate Source Only (von)* -- *Generate (Dollars, dollars)* -- *Generate (in, in)* -- *Generate (die, the)* -- *Generate (Untersuchungen, research)*

### Usage

To enable the OSM model in phrase-based decoder, just put the following in the EMS config file:

```
operation-sequence-model = "yes"
operation-sequence-model-order = 5
operation-sequence-model-settings = ""
```

### Factored Model

Due to data sparsity the lexically driven OSM model may often fall back to very small context sizes. This problem is addressed in Durrani et al. (2014b)<sup>35</sup> by learning operation sequences over generalized representations such as POS/Morph tags/word classes (See Section: Class-based Models). If the data has been augmented with additional factors, then use

```
operation-sequence-model-settings = "--factor 0-0+1-1"
```

<sup>35</sup><http://www.statmt.org/OSMOSES/factor-v2.pdf>



"0-0" will learn OSM model over lexical forms and "1-1" will learn OSM model over second factor (POS/Morph/Cluster-id etc.). Note that using

```
operation-sequence-model-settings = ""
```

for a factor augmented training data is an error. Use

```
operation-sequence-model-settings = "--factor 0-0"
```

if you only intend to train OSM model over surface form in such a scenario.

In case you are not using EMS and want to train OSM model manually, you will need to do two things:

1) Run the following command

```
/path-to-moses/scripts/OSM/OSM-Train.perl --corpus-f corpus.fr --corpus-e corpus.en --alignment aligned.grow-diag-final-and --order 5 --out-dir /path-to-experiment/model/OSM
```

2) Edit model/moses.ini to add

```
[feature]
```

```
...
```

```
OpSequenceModel name=OpSequenceModel0 num-features=5 path=/path-to-experiment/model/OSM/operat
```

```
... [weight]
```

```
...
```

```
OpSequenceModel0= 0.08 -0.02 0.02 -0.001 0.03
```

```
...
```

### Interpolated OSM Model

OSM model trained from the plain concatenation of in-domain data with large and diverse multi-domain data is sub-optimal. When other domains are sufficiently larger and/or different than the in-domain, the probability distribution can skew away from the target domain resulting in poor performance. The LM-like nature of the model provides motivation to apply methods such as perplexity optimization for model weighting. The idea is to train OSM model on each domain separately and interpolate them by minimizing optimizing perplexity on held-out tuning set. To know more read Durrani et al. (2015)<sup>36</sup>.

### Usage

Provide tuning files as additional parameter in the settings. For example:

<sup>36</sup><http://alt.qcri.org/~ndurrani/pubs/joint-models-domain.pdf>

```
interpolated-operation-sequence-model = "yes"
operation-sequence-model-order = 5
operation-sequence-model-settings = "--factor 0-0 --tune /path-to-tune-folder/tune_file --srilm-dir /path-to-srilm/bin/i686-m64"
```

This method requires word-alignment for the source and reference tuning files to generate operation sequences. This can be done using force-decoding of tuning set or by aligning tuning sets along with the training. The folder should contain files as (for example (tune.de , tune.en , tune.align).

Interpolation script does not work with LMPLZ and will require SRILM installation.

#### 4.4.3 Class-based Models

Automatically clustering the training data into word classes in order to obtain smoother distributions and better generalizations has been a widely known and applied technique in natural language processing. Using class-based models have shown to be useful when translating into morphologically rich languages. We use the mkcls utility in GIZA to cluster source and target vocabularies into classes. This is generally run during alignment process where data is divided into 50 classes to estimate IBM Model-4. Durrani et al. (2014b)<sup>37</sup> found using different number of clusters to be useful for different language pairs. To map the data (say corpus.fr) into higher number of clusters (say 1000) use:

```
/path-to-GIZA/statmt/bin/mkcls Üc1000 -n2 -p/path-to-corpus/corpus.fr -V/path-to-experiment/training/prepared.stepID/fr.vcb.classes opt
```

To annotate the data with cluster-ids add the following to the EMS-config file:

```
#####
# FACTOR DEFINITION

[INPUT-FACTOR]
temp-dir = $working-dir/training/factor

[INPUT-FACTOR:mkcls]

### script that generates this factor
#
factor-script = "/path-to-moses/scripts/training/wrappers/make-factor-brown-cluster-mkcls.perl 0 $working-dir/training/prepared.stepID/$input-extension.vcb.classes"

[OUTPUT-FACTOR:mkcls]

### script that generates this factor
#
factor-script = "/path-to-moses/scripts/training/wrappers/make-factor-brown-cluster-mkcls.perl 0 $working-dir/training/prepared.stepID/$output-extension.vcb.classes"
#####
```

<sup>37</sup><http://www.statmt.org/OSMOSES/factor-v2.pdf>

Adding the above will augment the training data with cluster-ids. These can be enabled in different models. For example to train a joint-source target phrase-translation model, add the following to the EMS-config file:

```
[TRAINING]

input-factors = word mkcls
output-factors = word mkcls
alignment-factors = "word -> word"
translation-factors = "word+mkcls -> word+mkcls"
reordering-factors = "word -> word"
decoding-steps = "t0"
```

To train a target sequence model over cluster-ids, add the following to the EMS config-file

```
[LM]

[LM:corpus-mkcls]
raw-corpus = /path-to-raw-monolingual-data/rawData.en
factors = mkcls
settings = "-unk"
```

To train operation sequence model over cluster-ids, use the following in the EMS config-file

```
[TRAINING]

operation-sequence-model-settings = "--factor 1-1"
```

if you want to train both lexically driven and class-based OSM models then use:

```
[TRAINING]

operation-sequence-model-settings = "--factor 0-0+1-1"
```

#### 4.4.4 Multiple Translation Tables and Back-off Models

Moses allows the use of multiple translation tables, but there are three different ways how they are used:

- **both** translation tables are used for scoring: This means that every translation option is collected from each table and scored by each table. This implies that each translation option has to be contained in each table: if it is missing in one of the tables, it can not be used.
- **either** translation table is used for scoring: Translation options are collected from one table, and additional options are collected from the other tables. If the same translation option (in terms of identical input phrase and output phrase) is found in multiple tables, separate translation options are created for each occurrence, but with different scores.
- the **union** of all translation options from all translation tables is considered. Each option is scored by each table. This uses a different mechanism than the above two methods and is discussed in the PhraseDictionaryGroup section below.

In any case, each translation table has its own set of weights.

First, you need to specify the translation tables in the section `[feature]` of the `moses.ini` configuration file, for instance:

```
[feature]
PhraseDictionaryMemory path=/my-dir/table1 ...
PhraseDictionaryMemory path=/my-dir/table2 ...
```

Secondly, you need to set weights for each phrase-table in the section `[weight]`.

Thirdly, you need to specify how the tables are used in the section `[mapping]`. As mentioned above, there are two choices:

- scoring with **both** tables:

```
[mapping]
0 T 0
0 T 1
```

- scoring with **either** table:

```
[mapping]
0 T 0
1 T 1
```

Note: what we are really doing here is using Moses' capabilities to use different decoding paths. The number before "T" defines a decoding path, so in the second example are two different decoding paths specified. Decoding paths may also contain additional mapping steps, such as generation steps and translation steps using different factors.

Also note that there is no way to have the option "use both tables, if the phrase pair is in both table, otherwise use only the table where you can find it". Keep in mind, that scoring a phrase pair involves a cost and lowers the chances that the phrase pair is used. To effectively use this option, you may create a third table that consists of the intersection of the two phrase tables, and remove shared phrase pairs from each table.

**PhraseDictionaryGroup:** You may want to combine translation tables such that you can use any option in either table, but all options are scored by all tables. This gives the flexibility of the **either** option with the reliable scoring of the **both** option. This is accomplished with the `PhraseDictionaryGroup` interface that combines any number of translation tables on a single decoding path.

In the `[feature]` section, add all translation tables as normal, but specify the `tuneable=false` option. Then add the `PhraseDictionaryGroup` entry, specifying your translation tables as members and the total number of features (sum of member feature numbers). It is recommended to activate `default-average-others=true`. When an option is found in some member tables but not others, its feature scores default to 0 ( $\log(1)$ ), a usually unreasonably high score. Turning on the averaging option tells Moses to fill in the missing scores by averaging the scores from tables that have seen the phrase (similar to the "fill-up" approach, but allowing any table to be filled in by all other tables while maintaining a full feature set for each). See the notes below for other options.

In the `[weight]` section, specify all 0s for member tables except for the index of  $\phi(e|f)$  (2 by default). This is only used for sorting options to apply the table-limit as the member tables will not contribute scores directly. The weights for the `PhraseDictionaryGroup` entry are the actual weights for the member tables in order. For instance, with 2 member tables of 4 features each, features 0-3 are the first table's 0-3 and 4-7 are the second table's 0-3.

Finally, only add a mapping for the index of the `PhraseDictionaryGroup` (number of member tables plus one).

```
[mapping]
0 T 2

[feature]
PhraseDictionaryMemory name=PhraseDictionaryMemory0 num-features=4 tuneable=false path=/my-dir/table1 ...
PhraseDictionaryMemory name=PhraseDictionaryMemory1 num-features=4 tuneable=false path=/my-dir/table2 ...
PhraseDictionaryGroup name=PhraseDictionaryGroup0 members=PhraseDictionaryMemory0,PhraseDictionaryMemory1 num-features=8 default-average-others=true

[weight]
PhraseDictionaryMemory0= 0 0 1 0
PhraseDictionaryMemory1= 0 0 1 0
PhraseDictionaryGroup0= 0.2 0.2 0.2 0.2 0.2 0.2 0.2 0.2
```

#### Notes:

- You may want to add indicator features to tell Moses what translation table each option originates from. Activating `phrase-counts=true` adds an indicator feature for each table to each option that returns 1 if the table contains the option and 0 otherwise. Similarly, activating `word-counts=true` adds a word count for each table. For instance, an option with target phrase length 3 would receive a 3 for each table that contains it and 0 for each that does not. Each of these options adds one feature per table, so set `num-features` and weights accordingly. (Adding both to the above example would yield `num-features=12`: 4 per model, 2 phrase counts, and 2 word counts)

**Backoff Models:** You may want to prefer to use the first table, and the second table only if there are no translations to be found in the first table. In other words, the second table is only a back-off table for unknown words and phrases in the first table. This can be specified by the option `decoding-graph-back-off`. The option also allows if the back-off table should only be used for single words (unigrams), unigrams and bigrams, everything up to trigrams, up to 4-grams, etc.

For example, if you have two translation tables, and you want to use the second one only for unknown words, you would specify:

```
[decoding-graph-backoff]
0
1
```

The `0` indicates that the first table is used for anything (which it always should be), and the `1` indicates that the second table is used for unknown n-grams up to size 1. Replacing it with a `2` would indicate its use for unknown unigrams and bigrams (unknown in the sense that the first table has no translations for it).

Also note, that this option works also with more complicated mappings than just a single translation table. For instance the following specifies the use of a simple translation table first, and as a back-off a more complex factored decomposition involving two translation tables and two generation tables:

```
[mapping]
0 T 0
1 T 1
1 G 0
1 T 2
1 G 1

[decoding-graph-backoff]
0
1
```

**Caveat: Multiple Translation Tables and Lexicalized Reordering** You may specify any number of lexicalized reordering models. Each of them will score any translation option, no matter where it comes from. If a lexicalized reordering table does not have an entry for a translation option, it will not assign any score to it. In other words, such a translation option is given the probability 1 no matter how it is reordered. This may not be the way you want to handle it.

For instance, if you have an *in-domain* translation table and an *out-of-domain* translation table, you can also provide an *in-domain* reordering table and an *out-of-domain* reordering table. If a phrase pair occurs in both translation tables, it will be scored by both reordering tables. However, if a phrase pairs occurs only in one of the phrase tables (and hence reordering tables), it

will be only score by one of them and get a free ride with the other. This will have the undesirable effect of discouraging phrase pairs that occur in both tables.

To avoid this, you can add default scores to the reordering table:

```
LexicalReordering name=LexicalReordering0 num-features=6 type=wbe-msd-bidirectional-fe-allff [...] default-scores=0.5,0.3,0.2,0.5,0.3,0.2
LexicalReordering name=LexicalReordering1 num-features=6 type=wbe-msd-bidirectional-fe-allff [...] default-scores=0.5,0.3,0.2,0.5,0.3,0.2
```

#### 4.4.5 Global Lexicon Model

The global lexicon model predicts the bag of output words from the bag of input words. It does not use an explicit alignment between input and output words, so word choice is also influenced by the input context. For details, please check Mauser et al., (2009)<sup>38</sup>.

The model is trained with the script

```
scripts/training/train-global-lexicon-model.perl --corpus-stem FILESTEM --lex-dir DIR --f EXT --e EXT
```

which requires the tokenized parallel corpus, and the lexicon files required for GIZA++.

You will need the MegaM<sup>39</sup> maximum entropy classifier from Hal Daume for training.

**Warning:** A separate maximum entropy classifier is trained for each target word, which is very time consuming. The training code is a very experimental state. It is very inefficient. For instance training a model on Europarl German-English with 86,700 distinct English words took about 10,000 CPU hours.

The model is stored in a text file.

File format:

```
county initiativen 0.34478
county land 0.92405
county schaffen 0.23749
county stehen 0.39572
county weiteren 0.04581
county europa -0.47688
```

Specification in `moses.ini`:

<sup>38</sup><http://www-i6.informatik.rwth-aachen.de/publications/download/628/Mauser-EMNLP-2009.pdf>

<sup>39</sup><http://www.cs.utah.edu/~hal/megam/>

```
[feature]
GlobalLexicalModel input-factor=0 output-factor=0 path=../global-lexicon.gz

[weight]
GlobalLexicalModel= 0.1
```

#### 4.4.6 Desegmentation Model

The in-Decoder desegmentation model is described in Salameh et al.(2016)<sup>40</sup>.

The **desegmentation model** extends the multi-stack phrase-based decoding paradigm to enable the extraction of word-level features inside morpheme-segmented models. It assumes that the target side of the parallel corpus has been segmented into morphemes where a plus "+" at the end of a token is a prefix, and at the beginning is a suffix. This allows us to define a complete word as a maximal morpheme sequence consisting of 0 or more prefixes, followed by at most one stem, and then 0 or more suffixes. The word-level features extracted by this model are an unsegmented Language Model(word-level LM) score, contiguity feature, and WordPenalty that counts the number of words rather than the default one that counts morphemes.

The word level features extracted from the hypotheses in the example are:

Unsegmented LM score for (lnŽr AfkArh)

WordPenalty = 2

Contiguity feature: (2 0 0) indicating that desegmented tokens are aligned to continuous source tokens

#### Usage:

The feature is activated by adding the following line to the Moses config file

```
DesegModel name=LM1 path=/path/to/unsegmented/lm.blm deseg-path=/path/to/desegmentation/table optimistic=(default=y) deseg-scheme=(default=r)
```

- optimistic=(y or n) where n means it is delayed option(explained in the paper).

The optimistic option assumes that the morphemes form a complete word at the end of each hypothesis, while the delayed option desegments the morphemes when it guarantees that they form a complete word.

- The desegmentation table has the form of:

<sup>40</sup>[https://sites.google.com/a/ualberta.ca/msalameh/554\\_Paper.pdf](https://sites.google.com/a/ualberta.ca/msalameh/554_Paper.pdf)



frequency(tab)UnsegmentedForm(tab)SegmentedForm.

You can download the desegmentation table used for English Arabic translation [here](#).

At this point, the frequency (count of occurrence of the unsegmented-segmented pair in a corpus) is not used but will later update it to handle multiple desegmentation options.

- deseg-scheme=(r or s) where r is rule-based desegmentation ONLY for Arabic and s is simple desegmentation that concatenates the tokens based on segmentation boundaries

#### 4.4.7 Advanced Language Models

Moses supports various neural, bilingual and syntactic language models (Section 5.13)

*Subsection last modified on August 08, 2016, at 12:17 AM*

## 4.5 Efficient Phrase and Rule Storage

### 4.5.1 Binary Phrase Tables with On-demand Loading

For larger tasks the phrase tables usually become huge, typically too large to fit into memory. Therefore, Moses supports a binary phrase table with on-demand loading, i.e. only the part of the phrase table that is required to translate a sentence is loaded into memory.

There are currently 3 binary formats to do this:

- OnDisk phrase-table. Works with SCFG models and phrase-based models.
- ~~Binary phrase-table. Works with phrase-based models only.~~
- Compact phrase-table. Works with phrase-based models only (may be extended in the near future). Small and fast. Described below.

#### On-Disk Phrase table

This phrase-table can be used for both phrase-based models and hierarchical models. (It can be used for fully syntax models too, but is likely to be very slow).

You first need to convert the rule table into a binary prefix format. This is done with the command `CreateOnDiskPt`:

```
CreateOnDiskPt [#source factors] [#target factors] [#scores] [ttable-limit] \
[index of p(e|f) (usually 2)] [input text pt] [output directory]
```

e.g.

```
~/CreateOnDiskPt 1 1 4 100 2 phrase-table.1.gz phrase-table.1.folder
```

This will create a directory, `phrase-table.1.folder`, with the following files:

```
Misc.dat
Source.dat
TargetColl.dat
TargetInd.dat
Vocab.dat
```

The configuration file `moses.ini` should also be changed so that the binary files is used instead of the text file. You should change it from:

```
[feature]
PhraseDictionaryMemory path=phrase-table.1.gz ....
```

to

```
[feature]
PhraseDictionaryOnDisk path=phrase-table.1.folder ....
```

#### 4.5.2 Compact Phrase Table

A compact phrase table implementation is available that is around 6 to 7 times smaller and than the original binary phrase table. It can be used in-memory and for on-demand loading. Like the original phrase table, this can only be used for phrase-based models. If you use this or the compact lexical reordering table below, please cite:

- Marcin Junczys-Dowmunt: **Phrasal Rank-Encoding: Exploiting Phrase Redundancy and Translational Relations for Phrase Table Compression**<sup>41</sup>, Proceedings of the Machine Translation Marathon 2012, The Prague Bulletin of Mathematical Linguistics, vol. 98, pp. 63-74, 2012.

<sup>41</sup><http://ufal.mff.cuni.cz/pbml/98/art-junczys-dowmunt.pdf>

Download the CMPH library from <http://sourceforge.net/projects/cmph/> and install according to the included instructions. Make sure the installation target directory contains an "include" and a "lib" directory. Next you need to recompile Moses with

```
./bjam --with-cmph=/path/to/cmph
```

Now, you can convert the standard ASCII phrase tables into the compact format. **Phrase tables are required to be sorted as above. For a maximal compression effect, it is advised to generate a phrase table with phrase-internal word alignment** (this is the default). If you want to compress a phrase table without alignment information, rather use `-encoding None` (see advanced options below). It is possible to use the default encoding (PREnc) without alignment information, but it will take much longer. For now, there may be problems to compact phrase tables on 32-bit systems since virtual memory usage quickly exceeds the 3 GB barrier.

Here is an example (standard phrase table `phrase-table`, with 4 scores) which produces a single file `phrase-table.minphr`:

```
mosesdecoder/bin/processPhraseTableMin -in phrase-table.gz -out phrase-table -nscores 4 -threads 4
```

In the Moses config file, specify the WHOLE file name of the phrase table:

```
[feature]
PhraseDictionaryCompact path=phrase-table.minphr ...
```

#### Options:

- `-in string` -- input table file name
- `-out string` -- prefix of binary table file
- `-nscores int` -- number of score components in phrase table
- `-no-alignment-info` -- do not include alignment info in the binary phrase table
- `-threads int` -- number of threads used for conversion
- `-T string` -- path to custom temporary directory

As for the original phrase table, the option `-no-alignment-info` omits phrase internal alignment information in the phrase table and should also be used if you provide a phrase table without alignment information in the phrase table. Also if no alignment data is given in the phrase table you should use `-encoding None` (see below), since the default compression method assumes that alignment information is present.

Since compression is quite processor-heavy, it is advised to use the `-threads` option to increase speed.

**Advanced options:** Default settings should be fine for most of your needs, but the size of the phrase table can be tuned to your specific needs with the help of the advanced options.

**Options:**

- `-encoding string` -- encoding type: PREnc REnc None (default PREnc)
- `-rankscore int` -- score index of P(t|s) (default 2)
- `-maxrank int` -- maximum rank for PREnc (default 100)
- `-landmark int` -- use landmark phrase every 2<sup>n</sup> source phrases (default 10)
- `-fingerprint int` -- number of bits used for source phrase fingerprints (default 16)
- `-join-scores` -- single set of Huffman codes for score components
- `-quantize int` -- maximum number of scores per score component
- `-no-warnings` -- suppress warnings about missing alignment data

**Encoding methods:** There are two encoding types that can be used on-top the standard compression methods, Phrasal Rank-Encoding (PREnc) and word-based Rank Encoding (REnc). PREnc (see Junczys-Dowmunt (MT Marathon 2012)<sup>42</sup> for details) is used by default and requires a phrase table with phrase-internal alignment to reach its full potential. PREnc can also work without explicit alignment information, but encoding is slower and the resulting file will be bigger, but smaller than without PREnc. The tool will warn you about every line that misses alignment information if you use PREnc or REnc. These warnings can be suppressed with `-no-warnings`. If you use PREnc with non-standard scores you should specify which score type is used for sorting with `-rankscore int`. By default this is P(t|s) which in the standard phrase table is the third score (index 2).

Basically with PREnc around, there is no reason to use REnc unless you really want to. It requires the lexical translation table `lex.f2e` to be present in the same directory as the text version phrase table. If no alignment information is available it falls back to None (See Junczys-Dowmunt (EAMT 2012)<sup>43</sup> for details on REnc and None).

None is the fastest encoding method, but produces the biggest files. Concerning translation speed, there is virtually no difference between the encoding methods when the phrase tables are later used with Moses, but smaller files result in lesser memory-usage, especially if the phrase tables are loaded entirely in-memory.

**Indexing options:** The properties of the source phrase index can be modified with the `-landmark` and `-fingerprint` options, changing these options can affect file size and translation quality, so do it carefully. Junczys-Dowmunt (TSD 2012)<sup>44</sup> contains a discussion of these values and their effects.

**Scores and quantization:** You can reduce the file size even more by using score quantization. E.g. with `-quantize 1000000`, a phrase table is generated that uses at most one million different scores for each score type. Be careful, low values will affect translation quality. By default, each score type is encoded with an own set of Huffman codes, with the `-join-scores` option only one set is used. If this option is combined with `-quantize N`, the summed number of different scores for all scores types will not exceed N.

**In-memory loading:** You can start Moses with the option `-minphr-memory` to load the compact phrase table directly into memory at start up. Without this option, on-demand loading is used by default.

<sup>42</sup><http://ufal.mff.cuni.cz/pbml/98/art-junczys-dowmunt.pdf>

<sup>43</sup><http://hltshare.fbk.eu/EAMT2012/html/Papers/57.pdf>

<sup>44</sup><http://www.staff.amu.edu.pl/~junczys/dokuwiki/lib/exe/fetch.php?cache=&media=wiki:mjd2012tsd1.pdf>

### 4.5.3 Compact Lexical Reordering Table

The compact lexical reordering table produces files about 12 to 15 times smaller than the original Moses binary implementation. As for the compact phrase table you need to install CMPH and link against it. **Reordering tables must be sorted in the same way as the phrase tables above.** The command below produces a single file `reordering-table.minlexr`.

```
mosesdecoder/bin/processLexicalTableMin -in reordering-table.gz -out reordering-table -threads 4
```

If you include the prefix in the Moses config file, the compact reordering table will be recognized and loaded automatically. You can start Moses with the option `-minlexr-memory` to load the compact lexical reordering table directly into memory at start up.

**Options:** See the compact phrase table above for a description of available common options.

### 4.5.4 Pruning the Translation Table

The translation table contains all phrase pairs found in the parallel corpus, which includes a lot of noise. To reduce the noise, recent work by Johnson et al. has suggested to prune out unlikely phrase pairs. For more detail, please refer to the paper:

H. Johnson, J. Martin, G. Foster and R. Kuhn. (2007) "Improving Translation Quality by Discarding Most of the Phrasetable". In Proceedings of the 2007 Joint Conference on Empirical Methods in Natural Language Processing and Computational Natural Language Learning (EMNLP-CoNLL), pp. 967-975.

#### Build Instructions

Moses includes a re-implementation of this method in the directory `contrib/sigtest-filter`. You first need to build it from the source files.

This implementation relies on Joy Zhang's. The source code can be download from github<sup>45</sup>. Joy's original code is here<sup>46</sup>.

1. download and extract the SALM source release.
2. in `SALM/Distribution/Linux` type: `make`
3. enter the directory `contrib/sigtest-filter` in the main Moses distribution directory
4. type `make SALMDIR=/path/to/SALM`

<sup>45</sup><https://github.com/moses-smt/salm>

<sup>46</sup><http://projectile.sv.cmu.edu/research/public/tools/salm/salm.htm#update>

## Usage Instructions

Using the `SALM/Bin/Linux/Index/IndexSA.032`, create a suffix array index of the source and target sides of your training bitext (`SOURCE`, `TARGET`).

```
% SALM/Bin/Linux/Index/IndexSA.032 TARGET
% SALM/Bin/Linux/Index/IndexSA.032 SOURCE
```

Prune the phrase table:

```
% cat phrase-table | ./filter-pt -e TARGET -f SOURCE -l FILTER-VALUE > phrase-table.pruned
```

`FILTER-VALUE` is the `-log prob` threshold described in Johnson et al. (2007)'s paper. It may be either `'a+e'`, `'a-e'`, or a positive real value. Run with no options to see more use-cases. A good setting is `-l a+e -n 30`, which also keeps only the top 30 phrase translations for each source phrase, based on  $p(e|f)$ .

If you filter an hierarchical model, add the switch `-h`.

## Using the EMS

To use this method in `experiment.perl`, you will have to add two settings in the `TRAINING` section:

```
salm-index = /path/to/project/salm/Bin/Linux/Index/IndexSA.064
sigtest-filter = "-l a+e -n 50"
```

The setting `salm-index` points to the binary to build the suffix array, and `sigtest-filter` contains the options for filtering (excluding `-e`, `-f`, `-h`). EMS detects automatically, if you filter a phrase-based or hierarchical model and if a reordering model is used.

### 4.5.5 Pruning the Phrase Table based on Relative Entropy

While the pruning method in Johnson et al. (2007)<sup>47</sup> is designed to remove spurious phrase pairs due to noisy data, it is also possible to remove phrase pairs that are redundant. That is, phrase pairs that can be composed by smaller phrase pairs in the model with similar probabilities. For more detail please refer to the following papers:

<sup>47</sup><http://www.aclweb.org/anthology/D/D07/D07-1103.pdf>

Ling, W., Graça, J., Trancoso, I., and Black, A. (2012). Entropy-based Pruning for Phrase-based Machine Translation. In Proceedings of the 2012 Joint Conference on Empirical Methods in Natural Language Processing and Computational Natural Language Learning (EMNLP-CoNLL), pp. 962-971.

Zens, R., Stanton, D., Xu, P. (2012). A Systematic Comparison of Phrase Table Pruning Technique. In Proceedings of the 2012 Joint Conference on Empirical Methods in Natural Language Processing and Computational Natural Language Learning (EMNLP-CoNLL), pp. 972-983.

The code from Ling et al. (2012)'s paper is available at `contrib/relent-filter`.

**Update** The code in `contrib/relent-filter` no longer works with the current version of Moses. To compile it, use an older version of Moses with this command:

```
git checkout RELEASE-0.91
```

### Build Instructions

The binaries for Relative Entropy-based Pruning are built automatically with Moses. However, this implementation also calculates the significance scores (Johnson et al., 2007)<sup>48</sup>, using a slightly modified version of the code by Chris Dyer, which is in `contrib/relent-filter/sigtest-filter`. This must be built using the same procedure:

1. Download and build SALM available here<sup>49</sup>
2. Run "make SALMDIR=/path/to/SALM" in "contrib/relent-filter/sigtest-filter" to create the executable filter-pt

### Usage Instructions

Checklist of required files (I will use <varname> to refer to these vars):

1. `s_train` - source training file
2. `t_train` - target training file
3. `moses_ini` - path to the Moses configuration file ( after tuning )
4. `pruning_binaries` - path to the relent pruning binaries ( should be "bin" if no changes were made )
5. `pruning_scripts` - path to the relent pruning scripts ( should be "contrib/relent-filter/scripts" if no changes were made )
6. `sigbin` - path to the sigtest filter binaries ( should be "contrib/relent-filter/sigtest-filter" if no changes were made )
7. `output_dir` - path to write the output

Build suffix arrays for the source and target parallel training data

<sup>48</sup><http://www.aclweb.org/anthology/D/D07/D07-1103.pdf>

<sup>49</sup><http://projectile.sv.cmu.edu/research/public/tools/salm/salm.htm#update>

```
% SALM/Bin/Linux/Index/IndexSA.032 <s_train>
% SALM/Bin/Linux/Index/IndexSA.032 <t_train>
```

Calculate phrase pair scores by running:

```
% perl <pruning_scripts>/calcPruningScores.pl -moses_ini <moses_ini> \
-training_s <s_train> -training_t <t_train> \
-prune_bin <pruning_binaries> -prune_scripts <pruning_scripts> \
-moses_scripts <path_to_moses>/scripts/training/ \
-workdir <output_dir> -dec_size 10000
```

This will create the following files in the <output\_dir>/scores/ dir:

1. count.txt - counts of the phrase pairs for N(s,t) N(s,\*) and N(\*,t)
2. divergence.txt - negative log of the divergence of the phrase pair
3. empirical.txt - empirical distribution of the phrase pairs N(s,t)/N(\*,\*)
4. rel\_ent.txt - relative entropy of the phrase pairs
5. significance.txt - significance of the phrase pairs

You can use any one of these files for pruning and also combine these scores using the script <pruning\_scripts>/interpolateScores.pl.

To actually prune a phrase table, run <pruning\_scripts>/prunePT.pl, this will prune phrase pairs based on the score file that is used. This script will prune the phrase pairs with lower scores first.

For instance, to prune 30% of the phrase table using relative entropy run:

```
% perl <pruning_scripts>/prunePT.pl -table <phrase_table_file> \
-scores <output_dir>/scores/rel_ent.txt -percentage 70 > <pruned_phrase_table_file>
```

You can also prune by threshold

```
% perl <pruning_scripts>/prunePT.pl -table <phrase_table_file> \
-scores <output_dir>/scores/rel_ent.txt -threshold 0.1 > <pruned_phrase_table_file>
```

The same must be done for the reordering table by replacing <phrase\_table\_file> with the <reord\_table\_file>



```
% perl <pruning_scripts>/prunePT.pl -table <reord_table_file> \
-scores <output_dir>/scores/rel_ent.txt -percentage 70 > <pruned_reord_table_file>
```

### Parallelization

The script `<pruning_scripts>/calcPruningScores.pl` requires the forced decoding of the whole set of phrase pairs in the phrase table, so unless it is used for a small corpora, it usually requires large amounts of time to process. Thus, we recommend users to run multiple instances of `<pruning_scripts>/calcPruningScores.pl` in parallel to process different parts of the phrase table.

To do this, run:

```
% perl <pruning_scripts>/calcPruningScores.pl -moses_ini <moses_ini> \
-training_s <s_train> -training_t <t_train> \
-prune_bin <pruning_binaries> -prune_scripts <pruning_scripts> \
-moses_scripts <path_to_moses>/scripts/training/ \
-workdir <output_dir> -dec_size 10000 -start 0 -end 100000
```

The `-start` and `-end` options tell the script to only calculate the results for phrase pairs between 0 and 99999.

Thus, an example of a shell script to run for the whole phrase table would be:

```
size='wc <phrase_table_file> | gawk '{print $1}''
phrases_per_process=100000

for i in $(seq 0 $phrases_per_process $size)
do
end='expr $i + $phrases_per_process'
perl <pruning_scripts>/calcPruningScores.pl -moses_ini <moses_ini> \
-training_s <s_train> -training_t <t_train> \
-prune_bin <pruning_binaries> -prune_scripts <pruning_scripts> \
-moses_scripts <path_to_moses>/scripts/training/
-workdir <output_dir>.$i-$end -dec_size 10000 -start $i -end $end
done
```

After all processes finish, simply join the partial score files together in the same order.

### 4.5.6 Pruning Rules based on Low Scores

Rules can be also removed simply because some of their scores are too low. This can be done at the time of the phrase table creation.

```
train-model.perl [...] \
-score-options="--MinScore FIELD1:THRESHOLD2[,FIELD2:THRESHOLD2[,FIELD3:THRESHOLD3]]"
```

where `FIELDn` is the position of the score (typically 2 for the direct phrase probability  $p(e|f)$ , or 0 for the indirect phrase probability  $p(f|e)$ ) and `THRESHOLD` the maximum probability allowed. A good setting is `2:0.0001`, which removes all rules, where the direct phrase translation probability is below 0.0001.

In EMS, this can be specified in the `TRAINING:score-settings` setting, for instance

```
score-settings = "--MinScore 2:0.0001"
```

*Subsection last modified on March 11, 2015, at 05:39 PM*

## 4.6 Search

### 4.6.1 Contents

- Generating n-Best Lists (Section 4.6.2)
- Minimum Bayes Risk Decoding (Section 4.6.3)
- Lattice MBR and Consensus Decoding (Section 4.6.4)
- Output Search Graph (Section 4.6.5)
- Early Discarding of Hypotheses (Section 4.6.6)
- Maintaining stack diversity (Section 4.6.7)
- Cube Pruning (Section 4.6.8)

### 4.6.2 Generating n-Best Lists

The generation of n-best lists (the top n translations found by the search according to the model) is pretty straight-forward. You simply have to specify the file where the n-best list will be stored and the size of the n-best list for each sentence.

Example: The command

```
% moses -f moses.ini -n-best-list listfile 100 < in
```

stores the n-best list in the file `listfile` with up to 100 translations per input sentence.

Here an example n-best list:

```
0 ||| we must discuss on greater vision . ||| d: 0 -5.56438 0 0 -7.07376 0 0 \
lm: -36.0974 -13.3428 tm: -39.6927 -47.8438 -15.4766 -20.5003 4.99948 w: -7 ||| -9.2298
0 ||| we must also discuss on a vision . ||| d: -10 -2.3455 0 -1.92155 -3.21888 0 -1.51918 \
lm: -31.5841 -9.96547 tm: -42.3438 -48.4311 -18.913 -20.0086 5.99938 w: -8 ||| -9.26197
0 ||| it is also discuss a vision . ||| d: -10 -1.63574 -1.60944 -2.70802 -1.60944 -1.94589 -1.08417 \
lm: -31.9699 -12.155 tm: -40.4555 -46.8605 -14.3549 -13.2247 4.99948 w: -7 ||| -9.31777
```

Each line of the n-best list file is made up of (separated by |||):

- sentence number (in above example 0, the first sentence)
- output sentence
- individual component scores (unweighted)
- weighted overall score

Note that it is possible (and very likely) that the n-best list contains many sentences that look the same on the surface, but have different scores. The most common reason for this is different phrase segmentation (two words may be mapped by a single phrase mapping, or by two individual phrase mappings for each word).

To produce an n-best list that only contains the first occurrence of an output sentence, add the word `distinct` after the file and size specification:

```
% moses -f moses.ini -n-best-list listfile 100 distinct < in
```

This creates an n-best list file that contains up to 100 distinct output sentences for each input sentences. Note that potentially a large numbers of candidate translations have to be examined to find the top 100. To keep memory usage in check only 20 times the specified number of distinct entries are examined. This factor can be changed with the switch `-n-best-factor`.

#### Options:

- `-n-best-list FILE SIZE [distinct]` -- output an n-best list of size `SIZE` to file `FILE`
- `-n-best-factor FACTOR` -- exploring at most `FACTOR*SIZE` candidates for distinct
- `-print-alignment-info-in-n-best` -- output of word-to-word alignments in the n-best list; it requires that w2w alignments are included in the phrase table. (See here (Section ??) for further details).

### 4.6.3 Minimum Bayes Risk Decoding

Minimum Bayes Risk (MBR) decoding was proposed by Kumar and Byrne (HLT/NAACL 2004)<sup>50</sup>. Roughly speaking, instead of outputting the translation with the highest probability, MBR decoding outputs the translation that is most similar to the most likely translations. This requires a similarity measure to establish *similar*. In Moses, this is a smoothed BLEU score.

Using MBR decoding is straight-forward, just use the switch `-mbr` when invoking the decoder.

Example:

```
% moses -f moses.ini -mbr < in
```

MBR decoding uses by default the top 200 distinct candidate translations to find the translation with minimum Bayes risk. If you want to change this to some other number, use the switch `-mbr-size`:

```
% moses -f moses.ini -decoder-type 1 -mbr-size 100 < in
```

MBR decoding requires that the translation scores are converted into probabilities that add up to one. The default is to take the log-scores at face value, but you may get better results with scaling the scores. This may be done with the switch `-mbr-scale`, so for instance:

```
% moses -f moses.ini -decoder-type 1 -mbr-scale 0.5 < in
```

#### Options:

- `-mbr` -- use MBR decoding
- `-mbr-size SIZE` -- number of translation candidates to consider (default 200)
- `-mbr-scale SCALE` -- scaling factor used to adjust the translation scores (default 1.0)

Note: MBR decoding and its variants is currently only implemented for the phrase-based decoder, not the chart decoder.

### 4.6.4 Lattice MBR and Consensus Decoding

These are extensions to MBR which may run faster or give better results. For more details see Tromble et al (2008)<sup>51</sup>, Kumar et al (2009)<sup>52</sup> and De Nero et al (2009)<sup>53</sup>. The n-gram posteriors (required for Lattice MBR) and the ngram expectations (for Consensus decoding) are both calculated using an algorithm described in De Nero et al (2010)<sup>54</sup>. Currently both lattice MBR and

<sup>50</sup>[http://mi.eng.cam.ac.uk/~wjb31/ppubs/hlt04\\_mbr\\_smt.pdf](http://mi.eng.cam.ac.uk/~wjb31/ppubs/hlt04_mbr_smt.pdf)

<sup>51</sup><http://www.aclweb.org/anthology-new/D/D08/D08-1065.pdf>

<sup>52</sup><http://www.aclweb.org/anthology-new/P/P09/P09-1019.pdf>

<sup>53</sup><http://www.aclweb.org/anthology-new/P/P09/P09-1064.pdf>

<sup>54</sup>[http://www.eecs.berkeley.edu/~denero/research/papers/naacl10\\_denero\\_combination.pdf](http://www.eecs.berkeley.edu/~denero/research/papers/naacl10_denero_combination.pdf)

consensus decoding are implemented as n-best list rerankers, in other words the hypothesis space is an n-best list (not a lattice).

Here's the list of options which affect both Lattice MBR and Consensus decoding.

**Options:**

- `-lmbr` -- use Lattice MBR decoding
- `-con` -- use Consensus decoding
- `-mbr-size SIZE` -- as for MBR
- `-mbr-scale SCALE` -- as for MBR
- `-lmbr-pruning-factor FACTOR` -- mean words per node in pruned lattice, as described in Tromble et al (2008) (default 30)

Lattice MBR has several further parameters which are described in the Tromble et al 2008 paper.

**Options:**

- `-lmbr-p P` -- The unigram precision (default 0.8)
- `-lmbr-r R` -- The ngram precision ratio (default 0.6)
- `-lmbr-thetas THETAS` Instead of specifying `p` and `r`, lattice MBR can be configured by specifying all the ngram weights and the length penalty (5 numbers). This is described fully in the references.
- `-lmbr-map-weight WEIGHT` The weight given to the map hypothesis (default 0)

Since Lattice MBR has so many parameters, a utility to perform a grid search is provided. This is in `moses-cmd/src` and is called `lmbrgrid`. A typical usage would be

```
% ./lmbrgrid -lmbr-p 0.4,0.6,0.8 -lmbr-r 0.4,0.6,0.8 -mbr-scale 0.1,0.2,0.5,1 -lmbr-pruning-factor \
30 -mbr-size 1000 -f moses.ini -i input.txt
```

In other words, the same Lattice MBR parameters as for Moses are used, but this time a comma separated list can be supplied. Each line in the output takes the following format:

```
<sentence-id> |||
<r> <pruning-factor> <scale> ||| <translation>
```

In the Moses Lattice MBR experiments that have been done to date, lattice MBR showed small overall improvements on a NIST Arabic data set (+0.4 over map, +0.1 over MBR), once the parameters were chosen carefully. Parameters were optimized by grid search on 500 sentences of held-out, and the following were found to be optimal

```
-lmbr-p 0.8 -lmbr-r 0.8 -mbr-scale 5 -lmbr-pruning-factor 50
```

### 4.6.5 Output Search Graph

It may be useful for many downstream applications to have a dump of the search graph, for instance to compile a word lattice. On the one hand you can use the `-verbose 3` option, which will give a trace of all generated hypotheses, but this creates logging of many hypotheses that get immediately discarded. If you do not want this, a better option is using the switch `-output-search-graph FILE`, which also provides some additional information.

The generated file contains lines that could be seen as both a dump of the states in the graph and the transitions in the graph. The state graph more closely reflects the hypotheses that are generated in the search. There are three types of hypotheses:

- The initial empty hypothesis is the only one that is not generated by a phrase translation

```
0 hyp=0 stack=0 [...]
```

- Regular hypotheses

```
0 hyp=17 stack=1 back=0 score=-1.33208 [...] covered=0-0 out=from now on
```

- Recombined hypotheses

```
0 hyp=5994 stack=2 back=108 score=-1.57388 [...] recombined=13061 [...] covered=2-2 out=be
```

The relevant information for viewing each line as a state in the search graph is the sentence number (initial `0`), the hypothesis id (`hyp`), the stack where the hypothesis is placed (same as number of foreign words covered, `stack`), the back-pointer to the previous hypotheses (`back`), the score so far (`score`), the last output phrase (`out`) and that phrase's foreign coverage (`covered`). For recombined hypotheses, also the superior hypothesis id is given (`recombined`).

The search graph output includes additional information that is computed after the fact. While the back-pointer and score (`back`, `score`) point to the cheapest path and cost to the beginning of the graph, the generated output also included the pointer to the cheapest path and score (`forward`, `fscore`) to the end of the graph.

One way to view the output of this option is a reflection of the search and all (relevant) hypotheses that are generated along the way. But often, we want to generate a word lattice, where the states are less relevant, but the information is in the transitions from one state to the next, each transition emitting a phrase at a certain cost. The initial empty hypothesis is irrelevant here, so we need to consider only the other two hypothesis types:

- Regular hypotheses

```
0 hyp=17 [...] back=0 [...] transition=-1.33208 [...] covered=0-0 out=from now on
```

- Recombined hypotheses

```
0 [...] back=108 [...] transition=-0.640114 recombined=13061 [...] covered=2-2 out=be
```

For the word lattice, the relevant information is the cost of the transition (`transition`), its output (`out`), maybe the foreign coverage (`covered`), and the start (`back`) and endpoint (`hyp`). Note that the states generated by recombined hypothesis are ignored, since the transition points to the superior hypothesis (`recombined`).

Here, for completeness sake, the full lines for the three examples we used above:

```
0 hyp=0 stack=0 forward=9 fscore=-107.279
0 hyp=17 stack=1 back=0 score=-1.33208 transition=-1.33208 \
forward=517 fscore=-106.484 covered=0-0 out=from now on
0 hyp=5994 stack=2 back=108 score=-1.57388 transition=-0.640114 \
recombined=13061 forward=22455 fscore=-106.807 covered=2-2 out=be
```

When using the switch `-output-search-graph-extended` (or short: `-osgx`), a detailed score breakdown is provided for each line. The format is the same as in the `n-best` list.

What is the difference between the search graph output file generated with this switch and the true search graph?

- It contains the additional forward costs and forward paths.
- It also only contains the hypotheses that are part of a fully connected path from the initial empty hypothesis to a final hypothesis that covers the full foreign input sentence.
- The recombined hypotheses already point to the correct superior hypothesis, while the `-verbose 3 log` shows the recombinations as they happen (recall that momentarily superior hypotheses may be recombined to even better ones down the road).

Note again that you can get the full search graph with the `-verbose 3` option. It is, however, much larger and mostly consists of discarded hypotheses.

#### Options:

- `-output-search-graph FILE --` output the search graph for each sentence in a file
- `-output-search-graph-extended FILE --` output the search graph for each sentence in a file, with detailed feature breakdown

### 4.6.6 Early Discarding of Hypotheses

During the beam search, many hypotheses are created that are too bad to be even entered on a stack. For many of them, it is even clear before the construction of the hypothesis that it would be not useful. Early discarding of such hypotheses hazards a guess about their viability. This is based on correct score except for the actual language model costs which are very expensive to compute. Hypotheses that, according to this estimate, are worse than the worst hypothesis of the target stack, even given an additional specified threshold as cushion, are not constructed at all. This often speeds up decoding significantly. Try threshold factors between 0.5 and 1.

**Options:**

- `-early-discarding-threshold THRESHOLD` -- use early discarding of hypotheses with the specified threshold (default: 0 = not used)

### 4.6.7 Maintaining stack diversity

The beam search organizes and compares hypotheses based on the number of foreign words they have translated. Since they may have different foreign words translated, we use future score estimates about the remaining sentence translation score.

Instead of comparing such apples and oranges, we could also organize hypotheses by their exact foreign word coverage. The disadvantage of this is that it would require an exponential number of stacks, but with reordering limits the number of stacks is only exponential with regard to maximum reordering distance.

Such coverage stacks are implemented in the search, and their maximum size is specified with the switch `-stack-diversity` (or `-sd`), which sets the maximum number of hypotheses per coverage stack.

The actual implementation is a hybrid of coverage stacks and foreign word count stacks: the stack diversity is a constraint on which hypotheses are kept on the traditional stack. If the stack diversity limits leave room for additional hypotheses according to the stack size limit (specified by `-s`, default 200), then the stack is filled up with the best hypotheses, using score so far and the future score estimate.

**Options:**

- `-stack-diversity LIMIT` -- keep a specified number of hypotheses for each foreign word coverage (default: 0 = not used)

### 4.6.8 Cube Pruning

Cube pruning, as described by Huang and Chiang (2007)<sup>55</sup>, has been implemented in the Moses decoder. This is in addition to the traditional search algorithm. The code offers developers the opportunity to implement different search algorithms using an extensible framework.

Cube pruning is faster than the traditional search at comparable levels of search errors. To get faster performance than the default Moses setting at roughly the same performance, use the parameter settings:

<sup>55</sup><http://www.aclweb.org/anthology/P/P07/P07-1019.pdf>



```
-search-algorithm 1 -cube-pruning-pop-limit 2000 -s 2000
```

This uses cube pruning (`-search-algorithm`) that adds 2000 hypotheses to each stack (`-cube-pruning-pop-limit 2000`) and also increases the stack size to 2000 (`-s 2000`). Note that with cube pruning, the size of the stack has little impact on performance, so it should be set rather high. The speed/quality trade-off is mostly regulated by the cube pruning pop limit, i.e. the number of hypotheses added to each stack. To guarantee deterministic output for a minor (about 3

Stacks are organized by the number of foreign words covered, so they may differ by which words are covered. You may also require that a minimum number of hypotheses is added for each word coverage (they may be still pruned out, however). This is done using the switch `-cube-pruning-diversity MINIMUM` which sets the minimum. The default is 0.

**Options:**

- `-search-algorithm 1` -- turns on cube pruning
- `-cube-pruning-pop-limit LIMIT` -- number of hypotheses added to each stack
- `-cube-pruning-diversity MINIMUM` -- minimum number of hypotheses from each coverage pattern
- `-cube-pruning-deterministic-search` -- use deterministic tie breaking during search

*Subsection last modified on November 06, 2015, at 07:15 PM*

## 4.7 OOVs

### 4.7.1 Contents

- Handling Unknown Words (Section 4.7.2)
- Unsupervised Transliteration Model (Section 4.7.3)
- Specification with `experiment.perl` (Section 4.7.3)
- Steps for use outside `experiment.perl` (Section 4.7.3)

### 4.7.2 Handling Unknown Words

Unknown words are copied verbatim to the output. They are also scored by the language model, and may be placed out of order. Alternatively, you may want to drop unknown words. To do so add the switch `-drop-unknown`.

When translating between languages that use different writing sentences (say, Chinese-English), dropping unknown words results in better BLEU scores. However, it is misleading to a human reader, and it is unclear what the effect on human judgment is.

**Options:**

- `-drop-unknown` -- drop unknown words instead of copying them into the output

### 4.7.3 Unsupervised Transliteration Model

Character-based translation model/Transliteration models have shown to be quite useful in MT for translating OOV words, for disambiguation and for translating closely related languages. A transliteration module as described in Durrani et al. (2014a)<sup>56</sup> has been integrated into Moses. It is completely unsupervised and language independent. It extracts transliteration corpus from the parallel data and builds a transliteration model from it which can then be used to translate OOV word or named-entities.

#### Specification with `experiment.perl`

To enable transliteration module add the following to the EMS config file:

```
[TRAINING]
transliteration-module = "yes"
```

It will extract transliteration corpus from the word-aligned parallel data and learn a character-based model from it.

To use the post-decoding transliteration (Method 2 as described in the paper) add the following lines

```
post-decoding-transliteration = "yes"
```

To use the in-decoding method (Method 3 as described in the paper) add the following lines

```
in-decoding-transliteration = "yes"
transliteration-file = /file containing list of words to be transliterated/
```

Post-decoding method obtains the list of OOV words automatically by running the decoder. The in-decoding method requires the user to provide the list of words to be transliterated. This gives a freedom to transliterate any additional words that might be known to the translation model but can also be transliterated in some scenarios. For example "Little" can be translated to `<img src='http://www.statmt.org/moses/img/choti.png' alt="" title="" />` in Urdu when it is used as adjective and transliterated to `<img src='http://www.statmt.org/moses/img/Little.png' alt="" title="" />` when it is a name as in "Stuart Little". You can add the OOV list as obtained from Method 2 if you don't want to add any other words. Transliterating all the words in the test-set might be helpful when translating between closely related language pairs such as Hindi-Urdu, Thai-Lao etc. See Durrani and Koehn (2014)<sup>57</sup> for a case-study.

<sup>56</sup><http://aclweb.org/anthology//E/E14/E14-4029.pdf>

<sup>57</sup><http://www.statmt.org/OSMOSES/interpolateTransliterate-v2.pdf>

### Steps for use outside experiment.perl

Execute command to train transliteration:

```
../mosesdecoder/scripts/Transliteration/train-transliteration-module.pl \
--corpus-f <foreign text> --corpus-e <target text> \
--alignment <path to aligned text> \
--moses-src-dir <moses decoder path> --external-bin-dir <external tools> \
--input-extension <input extension>--output-extension <output-extension> \
--srilm-dir <srilm binary path> --out-dir <path to generate output files>
```

Train moses with transliteration option on

```
nohup nice train-model.perl -root-dir train -corpus <path to parallel corpus> \
-f <foreign> -e <target> -alignment grow-diag-final-and \
-reordering msd-bidirectional-fe -lm 0:3:<path to lm>:8 \
-external-bin-dir <external tools> -post-decoding-translit yes \
-transliteration-phrase-table <path to transliteration phrase table> >& training.out &
```

First pass decoding to generate output oov file and translation output without transliteration

```
nohup nice <path to moses> -f <moses.ini file> \
-output-unknowns <path to oov file to be output> \
< <path to test input> > <path to test output> 2> <path to trace output>
```

Second pass decoding to transliterate to the output

```
./post-decoding-transliteration.pl --moses-src-dir <moses decoder> \
--external-bin-dir <external tools> --transliteration-model-dir <transliteration model> \
--oov-file <oov file obtained in previous step> \
--input-file <translated file obtained in previous step> \
--output-file <output translated file> \
--input-extension <foreign> --output-extension <english> \
--language-model <path to language model> \
--decoder <moses executable>
```

## 4.8 Hybrid Translation

### 4.8.1 Contents

- XML Markup (Section 4.8.2)
- Specifying Reordering Constraints (Section 4.8.3)
- Fuzzy Match Rule Table for Hierarchical Models (Section 4.8.4)
- Placeholder (Section 4.8.5)
- Training (Section 4.8.5)
- Decoding (Section 4.8.5)
- EMS (Section 4.8.5)
- Results (Section 4.8.5)

### 4.8.2 XML Markup

Sometimes we have external knowledge that we want to bring to the decoder. For instance, we might have a better translation system for translating numbers of dates. We would like to plug in these translations to the decoder without changing the model.

The `-xml-input` flag is used to activate this feature. It can have one of four values:

- **exclusive** Only the XML-specified translation is used for the input phrase. Any phrases from the phrase table that overlap with that span are ignored.
- **inclusive** The XML-specified translation competes with all the phrase table choices for that span.
- **constraint** The XML-specified translation competes with phrase table choices that contain the specified translation.
- **ignore** The XML-specified translation is ignored completely.
- **pass-through** (default) For backwards compatibility, the XML data is fed straight through to the decoder. This will produce erroneous results if the decoder is fed data that contains XML markup.

The decoder has an XML markup scheme that allows the specification of translations for parts of the sentence. In its simplest form, we can tell the decoder what to use to translate certain words or phrases in the sentence:

```
% echo 'das ist <np translation="a cute place">ein kleines haus</np>' \
| moses -xml-input exclusive -f moses.ini
this is a cute place

% echo 'das ist ein kleines <n translation="dwelling">haus</n>' \
| moses -xml-input exclusive -f moses.ini
this is a little dwelling
```

The words have to be surrounded by tags, such as `<np...>` and `</np>`. The name of the tags can be chosen freely. The target output is specified in the opening tag as a parameter value for a parameter that is called `english` for historical reasons (the canonical target language).

We can also provide a probability along with these translation choice. The parameter must be named `prob` and should contain a single float value. If not present, an XML translation option is given a probability of 1.

```
% echo 'das ist ein kleines <n translation="dwelling" prob="0.8">haus</n>' \  
| moses -xml-input exclusive -f moses.ini \  
this is a little dwelling
```

This probability isn't very useful without letting the decoder have other phrase table entries "compete" with the XML entry, so we switch to `inclusive` mode. This allows the decoder to use either translations from the model or the specified xml translation:

```
% echo 'das ist ein kleines <n translation="dwelling" prob="0.8">haus</n>' \  
| moses -xml-input inclusive -f moses.ini \  
this is a small house
```

The switch `-xml-input inclusive` gives the decoder a choice between using the specified translations or its own. This choice, again, is ultimately made by the language model, which takes the sentence context into account.

This doesn't change the output from the non-XML sentence because that `prob` value is first logged, then split evenly among the number of scores present in the phrase table. Additionally, in the toy model used here, we are dealing with a very dumb language model and phrase table. Setting the probability value to something astronomical forces our option to be chosen.

```
% echo 'das ist ein kleines <n translation="dwelling" prob="0.8">haus</n>' \  
| moses -xml-input inclusive -f moses.ini \  
this is a little dwelling
```

Multiple translation can be specified if separated by two bars (`||`):

```
% echo 'das ist ein kleines <n translation="dwelling||house" prob="0.8||0.2">haus</n>' \  
| moses -xml-input inclusive -f moses.ini
```

The XML-input implementation is **NOT** currently compatible with factored models or confusion networks.

**Options:**

- `-xml-input` ('pass-through' (default), 'inclusive', 'constraint', 'exclusive', 'ignore')

### 4.8.3 Specifying Reordering Constraints

For various reasons, it may be useful to specify reordering constraints to the decoder, for instance because of punctuation. Consider the sentence:

```
I said " This is a good idea . " , and pursued the plan .
```

The quoted material should be translated as a block, meaning that once we start translating some of the quoted words, we need to finish all of them. We call such a block a **zone** and allow the specification of such constraints using XML markup.

```
I said <zone> " This is a good idea . " </zone> , and pursued the plan .
```

Another type of constraints are **walls** which are hard reordering constraints: First all words before a wall have to be translated, before words afterwards are translated. For instance:

```
This is the first part . <wall /> This is the second part .
```

Walls may be specified within zones, where they act as **local walls**, i.e. they are only valid within the zone.

```
I said <zone> " <wall /> This is a good idea . <wall /> " </zone> , and pursued the plan .
```

If you add such markup to the input, you need to use the option `-xml-input` with either `exclusive` or `inclusive` (there is no difference between these options in this context).

Specifying reordering constraints around punctuation is often a good idea.

The switch `-monotone-at-punctuation` introduces walls around the punctuation tokens `, . ! ? : ; " .`

**Options:**

- walls and zones have to be specified in the input using the tags `<zone>`, `</zone>`, and `<wall>`.
- `-xml-input` -- needs to be exclusive or inclusive
- `-monotone-at-punctuation (-mp)` -- adds walls around punctuation `,.!?:;"`.

**4.8.4 Fuzzy Match Rule Table for Hierarchical Models**

Another method of extracting rules from parallel data is described in (Koehn, Senellart, 2010-1 AMTA)<sup>58</sup> and (Koehn, Senellart, 2010-2 AMTA)<sup>59</sup>.

To use this extraction method in the decoder, add this to the `moses.ini` file:

```
[feature]
PhraseDictionaryFuzzyMatch source=<source/path> target=<target/path> alignment=<alignment/path>
```

It has not yet been integrated into the EMS.

Note: The translation rules generated by this algorithm is intended to be used in the chart decoder. It can't be used in the phrase-based decoder.

**4.8.5 Placeholder**

Placeholders are symbols that replaces a word or phrase. For example, numbers ('42.85') can be replaced with a symbol '@num@'. Other words and phrases that can potentially be replaced with placeholders include dates and time, and named-entities.

This is good in training since the sparse numbers are replaced with more numerous placeholders symbols, producing more reliable statistics for the MT models.

The same reason also applies during decoding - the raw number is often an unknown symbol in the phrase-table and language models. Unknown symbols are translated as single words, disabling the advantage of phrasal translation. The reordering of unknown symbols can also be unreliable as we don't have statistics for it.

However, 2 issues arises using placeholder:

1. Translate the original word or phrase. In the example, '42.85' should be translated. If the language pair is en-fr, then it may be translated as '42,85'.
2. How do we insert this translation into the output if the word has be replaced with the placeholder.

Moses has support for placeholders in training and decoding.

<sup>58</sup><http://homepages.inf.ed.ac.uk/pkoehn/publications/amta2010.pdf>

<sup>59</sup><http://homepages.inf.ed.ac.uk/pkoehn/publications/tm-smt-amta2010.pdf>

## Training

When preparing your data, process with data with the script

```
scripts/generic/ph_numbers.perl -c
```

The script was designed to run after tokenization, that is, instead of tokenizing like this:

```
cat [RAW-DATA] | ./scripts/tokenizer/tokenizer.perl -a -l en > TOK-DATA
```

do this

```
cat [RAW-DATA] | ./scripts/tokenizer/tokenizer.perl -a -l en | scripts/generic/ph_numbers.perl -c > TOK-DATA
```

Do this for both source and target language, for parallel and monolingual data.

The script will replace numbers with the symbol @num@.

NB. - this script is currently very simple and language independent. It can be improved to create better translations.

During extraction, add the following to the extract command (phrase-based only for now):

```
./extract --Placeholders @num@ ....
```

This will discard any extracted translation rule which are non-consistent with the placeholders. That is, all placeholders must be aligned to 1-to-1 with a placeholder in the other language.

## Decoding

The input sentence must also be processed with the placeholder script to replace numbers with placeholder symbol. However, don't add the -c argument so that the original number will be retained in the output as an XML entry. For example,

```
generic $echo "you owe me $ 100 ." | ./ph_numbers.perl
```



will output

```
you owe me $ <ne translation="@num@" entity="100">@num@</ne> .
```

Add this to the decoder command when executing the decoder (phrase-based only for now):

```
./moses -placeholder-factor 1 -xml-input exclusive
```

The factor must NOT be one which is being used by the source side of the translation model. For vanilla models, only factor 0 is used.

The argument `-xml-input` can be any permitted value, except 'pass-through'.

The output from the decoder will contain the number, not the placeholder. This is the case in the best output, and the n-best list.

## EMS

The above changes can be added to the EMS config file.

For my (Hieu) experiment, these are the changes I made:

```
1. In the [GENERAL] section, change
input-tokenizer = "$misc-script-dir/normalize-punctuation.perl $input-extension | $moses-script-dir/tokenizer/tokenizer.perl -a -l $input-extension"
to
input-tokenizer = "$misc-script-dir/normalize-punctuation.perl $input-extension | $moses-script-dir/tokenizer/tokenizer.perl -a -l $input-extension | $moses-script-dir/gene

and change
output-tokenizer = "$misc-script-dir/normalize-punctuation.perl $output-extension | $moses-script-dir/tokenizer/tokenizer.perl -a -l $output-extension | $moses-script-dir/g
to
output-tokenizer = "$misc-script-dir/normalize-punctuation.perl $output-extension | $moses-script-dir/tokenizer/tokenizer.perl -a -l $output-extension | $moses-script-dir/g

2. In the [TRAINING] section, add
extract-settings = "--Placeholders @num@"

3. In the [TUNING] section, change
decoder-settings = "-threads 8"
to
decoder-settings = "-threads 8 -placeholder-factor 1 -xml-input exclusive"
And in the [EVALUATION] section, change
decoder-settings = "-mbr -mp -search-algorithm 1 -cube-pruning-pop-limit 5000 -s 5000 -threads 8"
to
decoder-settings = "-mbr -mp -search-algorithm 1 -cube-pruning-pop-limit 5000 -s 5000 -threads 8 -placeholder-factor 1 1 -xml-input exclusive"

4. In the [EVALUATION] section, add
input-tokenizer = "$misc-script-dir/normalize-punctuation.perl $input-extension | $moses-script-dir/tokenizer/tokenizer.perl -a -l $input-extension | $moses-script-dir/gene
output-tokenizer = "$misc-script-dir/normalize-punctuation.perl $output-extension | $moses-script-dir/tokenizer/tokenizer.perl -a -l $output-extension
```

"

## Results

This was tested on some experiments, trained with Europarl data. It didn't have a positive effect on BLEU score, even reducing it slightly.

However, it may still be helpful to users who translate text with lots of numbers or dates etc. Also, the recognizer script could be improved.

```
en-es:
baseline: 24.59.
with placeholder: 24.68
es-en:
baseline: 23.00
with placeholder: 22.84
en-cs:
baseline: 11.05
with placeholder: 10.62
cs-en:
baseline: 15.80
with placeholder: 15.62
```

*Subsection last modified on February 13, 2015, at 04:53 PM*

## 4.9 Moses as a Service

### 4.9.1 Contents

- Moses Server (Section 4.9.2)
- Open Machine Translation Core (OMTC) - A proposed machine translation system standard (Section 4.9.3)

### 4.9.2 Moses Server

The Moses server enables you to run the decoder as a server process, and send it sentences to be translated via XMLRPC<sup>60</sup>. This means that one Moses process can service distributed clients coded in Java, perl, python, php, or any of the many other languages which have XMLRPC libraries.

To build the Moses server, you need to have XMLRPC-c<sup>61</sup> installed and you need to add the argument `--with-xmlrpc-c=<path-xmlrpc-c-config>` to the configure arguments. It has been

---

<sup>60</sup><http://www.xmlrpc.com/>

<sup>61</sup><http://xmlrpc-c.sourceforge.net/>

tested with the latest stable version, 1.33.17. You will also need to configure Moses for multi-threaded operation, as described above.

Running `make` should then build an executable `server/mosesserver`. This can be launched using the same command-line arguments as `moses`, with two additional arguments to specify the listening port and log-file (`--server-port` and `--server-log`). These default to 8080 and `/dev/null` respectively.

A sample client is included in the `server` directory (in perl), which requires the `SOAP::Lite` perl module installed. To access the Moses server, an XMLRPC request should be sent to `http://host:port/RPC2` where the parameter is a map containing the keys `text` and (optionally) `align`. The value of the first of these parameters is the text to be translated and the second, if present, causes alignment information to be returned to the client. The client will receive a map containing the same two keys, where the value associated with the `text` key is the translated text, and the `align` key (if present) maps to a list of maps. The alignment gives the segmentation in target order, with each list element specifying the target start position (`tgt-start`), source start position (`src-start`) and source end position (`src-end`).

Note that although the Moses server needs to be built against multi-threaded moses, it can be run in single-threaded mode using the `--serial` option. This enables it to be used with non-threadsafe libraries such as (currently) `irstlm`.

### 4.9.3 Open Machine Translation Core (OMTC) - A proposed machine translation system standard

A proposed standard for machine translation APIs has been developed as part of the MosesCore<sup>62</sup> project (European Commission Grant Number 288487 under the 7th Framework Programme). It is called Open Machine Translation Core (OMTC) and defines a service interface for MT interfaces. This approach allows software engineers to wrap disparate MT back-ends such that they look identical to others no matter which flavour of MT system is being wrapped. This provides a standard protocol for talking to MT back-ends. In applications where many MT back-ends are to be used, OMTC allows for easier integration of these back-ends. Even in applications where one MT back-end is used, OMTC provides highly cohesive, yet low coupled, interfaces that should allow the back-end to be replaced by another with little effort.

OMTC standardises the follow aspects of an MT system:

- **Resources:** A resource is an object that is provided or constructed by a user action for use in an MT system. Examples of resources are: translation memory, glossary, MT engine, or a document. Two base resource types are defined, from which all other resource types are derived, they are primary and derived resources. Primary resources are resource which are constructed outside of the MT system and are made available to it, e.g., through an upload action. Primary resources are used to defined mono- and multi-lingual resources, translation memories and glossaries. Derived resources, on the other hand, are ones which have been constructed by user action inside of the MT system, e.g., a SMT engine.
- **Sessions:** A session is the period of time in which a user interacts with the MT system. The session interface hierarchy supports both user identity and anonymity. Mixin interfaces are, also, defined, to integrate with any authentication system.

<sup>62</sup><http://www.statmt.org/mosescore/>

- **Session Negotiation:** This is an optional part of the standard and, if used, shall allow a client and the MT server to come to an agreement about which features, resources (this includes exchange and document formats), pre-requisites (e.g. payment) and API version support is to be expected from both parties. If no agreement can be found then the client's session should be torn down, but this is completely application defined.
- **Authorisation:** OMTC can integrate with an authorisation system that may be being used in an MT system. It allows users and roles to be mapped into the API.
- **Machine Translation Engines:** Machine translation engines are derived resources which are capable of performing machine translation of, possibly, unseen sentences. An engine may be an SMT decoding pipeline, for instance. It is application defined as to how this part of the API is implemented. Optionally engine functionality can be mixed-in in order to add the following operations: composition, evaluation, parameter updating, querying, (re-)training, testing and updating. Potentially long running tasks return tickets in order for the application to track these tasks.
- **Translators:** Translators, as defined in OMTC, are a derived resource and are a conglomeration of, at least one of the following, an MT engine, a collection of translation memories, and a collection of glossaries. The translator interface provides methods for translation with returned tickets due to the long running nature of these tasks.

A reference implementation of OMTC has been constructed in Java v1.7. It is available in the `contrib/omtc` directory of the `mosesdecoder` as a Git submodule. Please see the `contrib/omtc/README` for details.

*Subsection last modified on October 28, 2015, at 11:35 AM*

## 4.10 Incremental Training

**NB: This page requires refactoring**

### 4.10.1 Contents

- Introduction (Section 4.10.2)
- Initial Training (Section 4.10.3)
- Virtual Phrase Tables Based on Sampling Word-aligned Bitexts (Section 4.10.4)
- Construction (Section 4.10.4)
- Use within EMS (Section 4.10.4)
- How to use memory-mapped dynamic suffix array phrase tables in the moses decoder (Section 4.10.4)
- Updates (Section 4.10.5)
- Preprocess New Data (Section 4.10.5)
- Prepare New Data (Section 4.10.5)
- Update and Compute Alignments (Section 4.10.5)

- Phrase Table Features for PhraseDictionaryBitextSampling (Section 4.10.6)
- Types of counts (Section 4.10.6)
- List of phrase table entry features (Section 4.10.6)
- Specification of forward/backward phrase-level conditional probabilities (Section 4.10.6)
- Specification of log count features (Section 4.10.6)
- Seeding the dynamic foreground corpus (Section 4.10.6)
- Checking the active feature set (Section 4.10.6)
- Suffix Arrays for Hierarchical Models (Section 4.10.7)
- Using the EMS (Section 4.10.7)

### 4.10.2 Introduction

Translation models for Moses are typically batch trained. That is, before training you have all the data you wish to use, you compute the alignments using GIZA, and from that produce a phrase table which you can use in the decoder. If some time later you wish to utilize some new training data, you must repeat the process from the start, and for large data sets, that can take quite some time.

Incremental training provides a way of avoiding having to retrain the model from scratch every time you wish to use some new training data. Instead of producing a phrase table with precalculated scores for all translations, the entire source and target corpora are stored in memory as a suffix array along with their alignments, and translation scores are calculated on the fly. Now, when you have new data, you simply update the word alignments, and append the new sentences to the corpora along with their alignments. Moses provides a means of doing this via XML RPC, so you don't even need to restart the decoder to use the new data.

Note that at the moment the incremental phrase table code is not thread safe.

### 4.10.3 Initial Training

This section describes how to initially train and use a model which support incremental training.

- Setup the EMS as normal, but use a modified version of GIZA++<sup>63</sup>.
- Add the line:

```
training-options = "-final-alignment-model hmm"
```

to the TRAINING section of your experiment configuration file.

- Train the system using the initial training data as normal.

---

<sup>63</sup><http://code.google.com/p/inc-giza-pp/>

#### 4.10.4 Virtual Phrase Tables Based on Sampling Word-aligned Bitexts

*phrase-based decoding only!*

##### Construction

1. Compile Moses with the bjam switch `--with-mm`
2. You need

```
- sentences aligned text files
- the word alignment between these files in symal output format
```

3. Build binary files

Let

`{L1}` be the extension of the language that you are translating from,  
`{L2}` the extension of the language that you want to translate into, and  
`{CORPUS}` the name of the word-aligned training corpus

```
% zcat ${CORPUS}.${L1}.gz | mtt-build -i -o /some/path/${CORPUS}.${L1}
% zcat ${CORPUS}.${L2}.gz | mtt-build -i -o /some/path/${CORPUS}.${L2}
% zcat ${CORPUS}.${L1}-${L2}.symal.gz | symal2mam /some/path/${CORPUS}.${L1}-${L2}.mam
% mmlex-build /some/path/${CORPUS} ${L1} ${L2} -o /some/path/${CORPUS}.${L1}-${L2}.lex
```

4. Define line in `moses.ini` (all needs to be on one line, the continuation marks are for typesetting in the pdf of this manual only):

**for static systems:**

```
PhraseDictionaryBitextSampling name=PT0 output-factor=0 \
path=/some/path/${CORPUS} L1=${L1} L2=${L2}
```

**for post-editing, e.g.:**

```
PhraseDictionaryBitextSampling name=PT0 output-factor=0 \
path=/some/path/${CORPUS} L1=${L1} L2=${L2} smooth=0 prov=1
```

(**Note:** the best configuration of phrase table features is still under investigation.)

Phrase table features are explained below

**Use within EMS**

Add the following lines to your config file to use the sampling phrase table within experiment.perl:

```
### build memory mapped suffix array phrase table
#
mmsapt = "pfwd=g pbwd=g smooth=0.01 rare=0 prov=0 sample=1000 workers=1"
binarize-all = $moses-script-dir/training/binarize-model.perl
```

OR (for use with interactive post-editing)

```
### build memory mapped suffix array phrase table
#
mmsapt = "pfwd=g pbwd=g smooth=0 rare=1 prov=1 sample=1000 workers=1"
binarize-all = $moses-script-dir/training/binarize-model.perl
```

DEPRECATED:

<del> \* Modify the moses.ini file found in <experiment-dir> /evaluation/filtered.<evaluation-set>.<run> to have a ttable-file entry as follows:</del>

<del>PhraseDictionaryDynSuffixArray source=<path-to-source-corpus> target=<path-to-target-corpus> alignment=<path-to-alignments></del>

<del>The source and target corpus paths should be to the tokenized, cleaned, and truecased versions found in <experiment-dir>/training/corpus.<run>.<lang>, and the alignment path should be to <experiment-dir>/model/aligned.<run>.grow-diag-final-and.</del>

**How to use memory-mapped dynamic suffix array phrase tables in the moses decoder**

(phrase-based decoding only) See Section Phrase Table Features for PhraseDictionaryBitextSampling (Section 4.10.6) below.

**4.10.5 Updates**

**Preprocess New Data** First, tokenize, clean, and truecase both target and source sentences (in that order) in the same manner as for the original corpus. You can see how this was done by looking at the <experiment-dir>/steps/<run>/CORPUS\_{tokenize,clean,truecase}.<run> scripts.

**Prepare New Data** The preprocessed data now needs to be prepared for use by GIZA. This involves updating the vocab files for the corpus, converting the sentences into GIZA's snt format, and updating the cooccurrence file.

plain2snt

```
$ $INC_GIZA_PP/GIZA++-v2/plain2snt.out <new-source-sentences> <new-target-sentences> \
-txt1-vocab <previous-source-vocab> -txt2-vocab <previous-target-vocab>
```

The previous vocabulary files for the original corpus can be found in <experiment-dir>/training/prepared. Running this command with the files containing your new tokenized, cleaned, and truecased source and target as txt1 and txt2 will produce new a new vocab file for each language and a couple of .snt files. Any further references to vocabs in commands or config files should reference the new vocabulary files just produced.

Note: if this command fails with the error message plain2snt.cpp:28: int loadVocab(): Assertion 'iid1.size()-1 == ID' failed., then change line 15 in plain2snt.cpp to vector<string> iid1(1),iid2(1); and recompile.

snt2cooc

```
$ $INC_GIZA_PP/bin/snt2cooc.out <new-source-vcb> <new-target-vcb> <new-source_target.snt> \
<previous-source-target.cooc > new.source-target.cooc
$ $INC_GIZA_PP/bin/snt2cooc.out <new-target-vcb> <new-source-vcb> <new-target_source.snt> \
<previous-target-source.cooc > new.target-source.cooc
```

This commands is run once in the source-target direction, and once in the target-source direction. The previous cooccurrence files can be found in <experiment-dir>/training/giza.<run>/<target-lang>-<source-lang>.cooc and <experiment-dir>/training/giza-inverse.<run>/<source-lang>-<target-lang>.cooc.

**Update and Compute Alignments** GIZA++ can now be run to update and compute the alignments for the new data. This should be run in the source to target, and target to source directions. A sample GIZA++ config file is given below for the source to target direction; for the target to source direction, simply swap mentions of target and source.

```
S: <path-to-src-vocab>
T: <path-to-tgt-vocab>
C: <path-to-src-to-tgt-snt>
O: <prefix-of-output-files>
cooccurrencefile: <path-to-src-tgt-cooc-file>
modelliterations: 1
modelldumpfrequency: 1
```



```
hmmiterations: 1
hmmdumpfrequency: 1
model2iterations: 0
model3iterations: 0
model4iterations: 0
model5iterations: 0
emAlignmentDependencies: 1
step_k: 1
oldTrPrbs: <path-to-original-thmm>
oldAlPrbs: <path-to-original-hhmm>
```

To run GIZA++ with these config files, just issue the command

```
GIZA++ <path-to-config-file>
```

With the alignments updated, we can get the alignments for the new data by running the command:

```
giza2bal.pl -d <path-to-updated-tgt-to-src-ahmm> -i <path-to-updated-src-to-tgt-ahmm> \
| symal -alignment="grow" -diagonal="yes" -final="yes" -both="yes" > new-alignment-file
```

- Update Model

Now that alignments have been computed for the new sentences, you can use them in the decoder. Updating a running Moses instance is done via XML RPC, however to make the changes permanent, you must append the tokenized, cleaned, and truecased source and target sentences to the original corpora, and the new alignments to the alignment file.

#### 4.10.6 Phrase Table Features for PhraseDictionaryBitextSampling

**This is still work in progress. Feature sets and names may change at any time without notice. It is best not to rely on defaults but to always specify for each feature explicitly whether or not it is to be used.**

Some of the features below are described in the following publication: Ulrich Germann. 20014. "Dynamic Phrase Tables for Statistical Machine Translation in an Interactive Post-editing Scenario". *AMTA 2014 Workshop on Interactive and Adaptive Machine Translation*. Vancouver, BC, Canada.

## Types of counts

The sampling phrase table offers a number of fixed and configurable phrase table features. For the descriptions below, it is necessary to distinguish different kinds of counts.

- **raw** [r]: counts: raw monolingual phrase occurrence counts
- **sample size** [s]: number of samples considered
- **good** [g]: number of samples with a coherent translations (i.e., at least one target phrase could be extracted)
- **joint** [j]: joint phrase occurrences

## List of phrase table entry features

Phrase pair features are specified as follows:

- lexical forward and backward probabilities (currently always included)
- `pfwd=spec` log of lower bound on forward phrase-level conditional probability; details below
- `pbwd=spec` log of lower bound on backward phrase-level conditional probability; details below
- `logcnt=spec` logs of plain counts
- `coh={1|0}` log of coherence (include / don't include)
- `rare=param`: global rarity penalty  $param/(j + param)$ , where *param* determines the steepness of the asymptotic penalty, which slowly decreases towards zero as the number of joint phrase occurrences *j* increases.
- `prov=param`: foreground/background-specific provenance reward  $j/(j + param)$  that asymptotically grows to 1 for the specific corpus as the number of joint phrase occurrences *j* increases.
- `unal=spec`: number of unaligned words in the phrase pair; detailed documentation pending.
- `pcnt=spec`: phrase penalty ??? (introduced by M. Denkowski)
- `wcnt=spec`: word penalty ??? (introduced by M. Denkowski)
- `lenrat={1|0}`: use / don't use the phrase length ratio feature described here<sup>64</sup>

**Specification of forward/backward phrase-level conditional probabilities** The specification for `pfwd` and `pbwd` consists of one or more of the letters 'r', 's', and 'g' plus optionally the '+' sign. The letter (r/s/g) determines the denominator (see types of counts above); the plus sign indicates that these features are to be computed separately for (static) background corpus and (dynamic) foreground corpus. For example, `pfwd=g+` will compute the lower bound on the probability given *j* joint occurrences of the phrase pair in question in *g* samples, computed separately for the two corpora. The confidence level for the lower bound is specified by the parameter `smooth=value`, where *value* is a value between 0 and 1 indicating the risk of overestimating the true probability given the evidence that we are willing to take. `smooth=0` causes the maximum likelihood estimate to be used.

<sup>64</sup><https://ufal.mff.cuni.cz/pbml/104/art-germann.pdf>

**Specification of log count features**

- r1 include raw counts for L1 phrase
- r2 include raw counts for L2 phrase
- s1 include sample size for L1 phrase
- g1 include number of samples used ('good samples')
- j include joint phrase counts

as with `pfwd/pbwd`, a '+' at the end indicates that the features are to be provided per corpus, not pooled. E.g., `logcnt=g1jr2+`: provide log of the number of samples actually used for phrase extraction, joint counts, and raw L2 phrase counts.

**Seeding the dynamic foreground corpus** `extra=path` allows you to specify a set of files `path.L1`, `path.L2`, and `path.symal` to seed the dynamic foreground corpus with a word-aligned corpus in text format. `path.L1` and `path.L2` must be one sentence per line, cased as required for translation. `path.symal` should contain the word alignment info in symal output format.

**Checking the active feature set**

the program `ptable-describe-features` can be used to list the features used in the order they are provided by the phrase table:

```
cat moses.ini | ptable-describe-features
```

**4.10.7 Suffix Arrays for Hierarchical Models**

The phrase-based model uses a suffix array implementation which comes with Moses.

If you want to use suffix arrays for hierarchical models, use Adam Lopez's implementation. The source code for this is currently available in `cdec`<sup>65</sup>. You have to compile `cdec` so please follow its instructions.

You also need to install `pycdec`

```
cd python
python setup.py install
```

Note: the suffix array code requires Python 2.7 or above. If you have Linux installations which are a few years old, check this first.

Adam Lopez's implementation writes the suffix array to binary files, given the parallel training data and word alignment. The Moses toolkit has a wrapper script which simplifies this process:

<sup>65</sup><https://github.com/redpony/cdec/>

```
./scripts/training/wrappers/adam-suffix-array/suffix-array-create.sh \
[path to cdec/python/pkg] \
[source corpus] \
[target corpus] \
[word alignment] \
[output suffix array directory] \
[output glue rules]
```

WARNING - This requires a lot of memory (approximately 10GB for a parallel corpus of 15 million sentence pairs)

Once the suffix array has been created, run another Moses wrapper script to extract the translation rules required for a particular set of input sentences.

```
./scripts/training/wrappers/adam-suffix-array/suffix-array-extract.sh \
[suffix array directory from previous command] \
[input sentences] \
[output rules directory] \
[number of jobs]
```

This command creates one file for each input sentences with just the rules required to decode that sentences. eg.

```
# ls filtered.5/
grammar.0.gz      grammar.3.gz      grammar.7.gz
grammar.1.gz      grammar.4.gz      grammar.8.gz
grammar.10.gz     grammar.5.gz      grammar.9.gz ....
```

Note - these files are gzipped, and the rules are formatted in the Hiero format, rather than the Moses format. eg.

```
# zcat filtered.5/grammar.out.0.gz | head -1
[X] ||| monsieur [X,1] ||| mr [X,1] ||| 0.178069829941 2.04532289505 1.8692317009 0.268405526876 0.160579100251 0.0 0.0 ||| 0-0
```

To use these rules in the decoder, put this into the ini file

```
PhraseDictionaryALSuffixArray name=TranslationModel0 table-limit=20 \  
num-features=7 path=[path-to-filtered-dir] input-factor=0 output-factor=0  
PhraseDictionaryMemory name=TranslationModel1 num-features=1 \  
path=[path-to-glue-grammar] input-factor=0 output-factor=0
```

### Using the EMS

Adam Lopez's suffix array implementation is integrated into the EMS, where all of the above commands are executed for you. Add the following line to your EMS config file:

```
[TRAINING]  
suffix-array = [pycdec package path]  
# e.g.  
# suffix-array = /home/github/cdec/python/pkg
```

and the EMS will use the suffix array instead of the usual Moses rule extraction algorithms.

You can also have multiple extractors running at once

```
[GENERAL]  
sa_extractors = 8
```

WARNING: currently the pycdec simply forks itself N times, therefore this will require N times more memory. Be careful with the interaction with multiple evaluations in parallel in EMS and large suffix arrays.

*Subsection last modified on October 26, 2015, at 10:20 PM*

## 4.11 Domain Adaptation

### 4.11.1 Contents

- Translation Model Combination (Section 4.11.2)
- Linear Interpolation and Instance Weighting (Section 4.11.2)
- Fill-up Combination (Section 4.11.2)
- Back-Off Combination (Section 4.11.2)

- OSM Model Combination (Interpolated OSM) (Section 4.11.3)
- Online Translation Model Combination (Multimodel phrase table type) (Section 4.11.4)
- Online Computation of Translation Model Features Based on Sufficient Statistics (Section 4.11.4)
- Alternate Weight Settings (Section 4.11.5)
- Modified Moore-Lewis Filtering (Section 4.11.6)

#### 4.11.2 Translation Model Combination

You can combine several phrase tables by linear interpolation or instance weighting using the script `contrib/tmcombine/tmcombine.py`, or by fill-up or back-off using the script `contrib/combine-ptables/combine-ptables.pl`.

##### Linear Interpolation and Instance Weighting

Linear interpolation works with any models; for instance weighting, models need to be trained with the option `-write-lexical-counts` so that all sufficient statistics are available. You can set corpus weights by hand, and instance weighting with uniform weights corresponds to a concatenation of your training corpora (except for differences in word alignment).

You can also set weights automatically so that perplexity on a tuning set is minimized. To obtain a tuning set from a parallel tuning corpus, use the Moses training pipeline to automatically extract a list of phrase pairs. The file `model/extract.sorted.gz` is in the right format.

An example call: (this weights `test/model1` and `test/model2` with instance weighting (`-m counts`) and `test/extract` as development set for perplexity minimization, and writes the combined phrase table to `test/phrase-table_test5`)

```
python tmcombine.py combine_given_tuning_set test/model1 test/model2 \ \ -m counts -o test/phrase-table_test5 -r test/extract
```

More information is available in (Sennrich, 2012 EACL)<sup>66</sup> and `contrib/tmcombine/README.md`.

##### Fill-up Combination

This combination technique is useful when the relevance of the models is known a priori: typically, when one is trained on in-domain data and the others on out-of-domain data.

Fill-up preserves all the entries and scores coming from the first model, and adds entries from the other models only if new. Moreover, a binary feature is added for each additional table to denote the provenance of an entry. These binary features work as scaling factors that can be tuned directly by MERT along with other models' weights.

<sup>66</sup><http://www.aclweb.org/anthology/E/E12/E12-1055.pdf>

Fill-up can be applied to both translation and reordering tables.

Example call, where `ptable0` is the in-domain model:

```
perl combine-ptables.pl --mode=fillup  \ \      ptable0 ptable1 ... ptableN > ptable-fillup
```

More information is available in (Bisazza et al., 2011 IWSLT)<sup>67</sup> and `contrib/combine-ptables/README.md`.

### Back-Off Combination

An additional combination technique, called back-off, is available, which is a simplified version of fill-up (Section 4.11.2). The only difference is that back-off technique does not generate the binary feature denoting the provenance an entry. This is also the main advantage of back-off: the combined table (`ptable-backoff`) contains the exact number of scores of their combining tables (`ptable0`, `ptable1`, ... `ptableN`).

Example call, where `ptable0` is the in-domain model:

```
perl combine-ptables.pl --mode=backoff  \ \      ptable0 ptable1 ... ptableN > ptable-backoff
```

### 4.11.3 OSM Model Combination (Interpolated OSM)

OSM model trained from the plain concatenation of in-domain data with large and diverse multi-domain data is sub-optimal. When other domains are sufficiently larger and/or different than the in-domain, the probability distribution can skew away from the target domain resulting in poor performance. The LM-like nature of the model provides motivation to apply methods such as perplexity optimization for model weighting. The idea is to train OSM model on each domain separately and interpolate them by minimizing optimizing perplexity on held-out tuning set. To know more read Durrani et al. (2015)<sup>68</sup>.

#### Usage

Provide tuning files as additional parameter in the settings. For example:

```
interpolated-operation-sequence-model = "yes"
operation-sequence-model-order = 5
operation-sequence-model-settings = "--factor 0-0 --tune /path-to-tune-folder/tune_file --srilm-dir /path-to-srilm/bin/i686-m64"
```

<sup>67</sup><http://www.mt-archive.info/IWSLT-2011-Bisazza.pdf>

<sup>68</sup><http://alt.qcri.org/~ndurrani/pubs/joint-models-domain.pdf>

This method requires word-alignment for the source and reference tuning files to generate operation sequences. This can be done using force-decoding of tuning set or by aligning tuning sets along with the training. The folder should contain files as <tune.de , tune.en , tune.align>. Interpolation script does not work with LMPLZ and will require SRILM installation.

#### 4.11.4 Online Translation Model Combination (Multimodel phrase table type)

Additionally to the log-linear combination of translation models, Moses supports additional methods to combine multiple translation models into a single virtual model, which is then passed to the decoder. The combination is performed at decoding time.

In the config, add a feature `PhraseDictionaryMultiModel`, which refers to its components as follows:

```
[mapping]
0 T 2 [or whatever the zero-based index of PhraseDictionaryMultiModel is]

[feature]
PhraseDictionaryMemory tuneable=false num-features=4 input-factor=0 output-factor=0 path=/path/to/model1/phrase-table.gz table-limit=20
PhraseDictionaryMemory tuneable=false num-features=4 input-factor=0 output-factor=0 path=/path/to/model2/phrase-table.gz table-limit=20
PhraseDictionaryMultiModel num-features=4 input-factor=0 output-factor=0 table-limit=20 mode=interpolate lambda=0.2,0.8 components=PhraseDictionaryMemory0,PhraseDictionaryMemory1

[weight]

PhraseDictionaryMemory0= 0 0 1 0
PhraseDictionaryMemory1= 0 0 1 0
PhraseDictionaryMultiModel0= 0.2 0.2 0.2 0.2
```

As component models, `PhraseDictionaryMemory`, `PhraseDictionaryBinary` and `PhraseDictionaryCompact` are supported (you may mix them freely). Set the key `tuneable=false` for all component models; their weights are only used for table-limit pruning, so we recommend `0 0 1 0 0` (which means `p(e|f)` is used for pruning).

There are two additional valid options for `PhraseDictionaryMultiModel`, `mode` and `lambda`. The only `mode` supported so far is `interpolate`, which linearly interpolates all component models, and passes the results to the decoder as if they were coming from a single model. Results are identical to offline interpolation with `tmcombine.py` and `-mode interpolate`, except for pruning and rounding differences. The weights for each component model can be configured through the key `lambda`. The number of weights must be one per model, or one per model per feature.

Weights can also be set for each sentence during decoding through `mosesserver` by passing the parameter `lambda`. See `contrib/server/client_multimodel.py` for an example. Sentence-level weights override those defined in the config.

With a running Moses server instance, the weights can also be optimized on a tuning set of phrase pairs, using perplexity minimization. This is done with the XMLRPC method `optimize` and the parameter `phrase_pairs`, which is an array of phrase pairs, each phrase pair being an array of two strings. For an example, consult `contrib/server/client_multimodel.py`. Online optimization depends on the `dlib` library, and requires Moses to be compiled with the flag `--with-dlib=/path/to/dlib`. Note that optimization returns a weight vector, but does not affect the running system. To use the optimized weights, either update the `moses.ini` and restart the server, or pass the optimized weights as a parameter for each sentence.



### Online Computation of Translation Model Features Based on Sufficient Statistics

With default phrase tables, only linear interpolation can be performed online. Moses also supports computing translation probabilities and lexical weights online, based on a (weighted) combination of the sufficient statistics from multiple corpora, i.e. phrase and word (pair) frequencies.

As preparation, the training option `--write-lexical-counts` must be used when training the translation model. Then, use the script `scripts/training/create_count_tables.py` to convert the phrase tables into phrase tables that store phrase (pair) frequencies as their feature values.

```
scripts/training/create_count_tables.py /path/to/model/phrase-table.gz /path/to/model
```

The format for the translation tables in the `moses.ini` is similar to that of the `Multimodel` type, but using the feature type `PhraseDictionaryMultiModelCounts` and additional parameters to specify the component models. Four parameters are required: `components`, `target-table`, `lex-f2e` and `lex-e2f`. The files required for the first two are created by `create_count_tables.py`, the last two during training of the model with `--write-lexical-counts`. Binarized/compacted tables are also supported (like for `PhraseDictionaryMultiModel`). Note that for the target count tables, phrase table filtering needs to be disabled (`filterable=false`).

```
[mapping]
0 T 4 [or whatever the zero-based index of PhraseDictionaryMultiModelCounts is]

[feature]
PhraseDictionaryMemory tuneable=false num-features=3 input-factor=0 output-factor=0 path=/path/to/model1/count-table.gz table-limit=20
PhraseDictionaryMemory tuneable=false num-features=3 input-factor=0 output-factor=0 path=/path/to/model2/count-table.gz table-limit=20

PhraseDictionaryMemory tuneable=false filterable=false num-features=1 input-factor=0 output-factor=0 path=/path/to/model1/count-table-target.gz
PhraseDictionaryMemory tuneable=false filterable=false num-features=1 input-factor=0 output-factor=0 path=/path/to/model2/count-table-target.gz

PhraseDictionaryMultiModelCounts num-features=4 input-factor=0 output-factor=0 table-limit=20 mode=instance_weighting lambda=1.0,10.0 components=PhraseDictionaryMemory0,Phr

[weight]
PhraseDictionaryMemory0= 1 0 0
PhraseDictionaryMemory1= 1 0 0
PhraseDictionaryMemory2= 1
PhraseDictionaryMemory3= 1
PhraseDictionaryMultiModelCounts0= 0.00402447059454402 0.0685647475075862 0.294089113124688 0.0328320356515851
```

Setting and optimizing weights is done as for the `Multimodel` phrase table type, but the supported modes are different. The weights of the component models are only used for table-limit pruning, and the weight `1 0 0`, which is pruning by phrase pair frequency, is recommended.

The following modes are implemented:

- `instance_weighting`: weights are applied to the sufficient statistics (i.e. the phrase (pair) frequencies), not to model probabilities. Results are identical to offline optimization with `tmcombine.py` and `-mode counts`, except for pruning and rounding differences.
- `interpolate`: both phrase and word translation probabilities (the latter being used to compute lexical weights) are linearly interpolated. This corresponds to `tmcombine.py` with `-mode interpolate` and `-recompute-lexweights`.

### 4.11.5 Alternate Weight Settings

**Note: this functionality currently does not work with multi-threaded decoding.**

You may want to translate different some sentences with different weight settings than others, due to significant differences in genre, text type, style, or even to have separate settings for headlines and questions.

Moses allows you to specify alternate weight settings in the configuration file, e.g.:

```
[alternate-weight-setting]
id=strong-lm
Distortion0= 0.1
LexicalReordering0= 0.1 0.1 0.1 0.1 0.1 0.1
LM0= 1
WordPenalty0= 0
TranslationModel0= 0.1 0.1 0.1 0.1 0
```

This example specifies a weight setting with the identifying name `strong-lm`.

When translating a sentence, the default weight setting is used, unless the use of an alternate weight setting is specified with an XML tag:

```
<seg weight-setting="strong-lm">This is a small house .</seg>
```

This functionality also allows for the selective use of feature functions and decoding graphs (unless decomposed factored models are used, a decoding graph corresponds to a translation table).

Feature functions can be turned off by adding the parameter `ignore-ff` to the identifier line (names of feature functions, separated by comma), decoding graphs can be ignored with the parameter `ignore-decoding-path` (number of decoding paths, separated by comma).

Note that with these additional options all the capability of the previously (pre-2013) implemented "Translation Systems" is provided. You can even have one configuration file and one Moses process to translate two different language pairs that share nothing but basic features.

See the example below for a complete configuration file with exactly this setup. In this case, the default weight setting is not useful since it mixes translation models and language models from both language pairs.

```

[input-factors]
0

# mapping steps
[mapping]
0 T 0
1 T 1

[distortion-limit]
6

# feature functions
[feature]
Distortion
UnknownWordPenalty
WordPenalty
PhraseDictionaryBinary name=TranslationModel0 num-features=5 \
path=/path/to/french-english/phrase-table output-factor=0
LexicalReordering num-features=6 name=LexicalReordering0 \
type=wbe-msd-bidirectional-fe-allff input-factor=0 output-factor=0 \
path=/path/to/french-english/reordering-table
KENLM name=LM0 order=5 factor=0 path=/path/to/french-english/language-model lazyken=0
PhraseDictionaryBinary name=TranslationModel1 num-features=5 \
path=/path/to/german-english/phrase-table output-factor=0
LexicalReordering num-features=6 name=LexicalReordering1 \
type=wbe-msd-bidirectional-fe-allff input-factor=0 output-factor=0 \
path=/path/to/german-english/reordering-table
KENLM name=LM1 order=5 factor=0 path=/path/to/german-english/language-model lazyken=0

# core weights - not used
[weight]
Distortion0= 0
WordPenalty0= 0
TranslationModel0= 0 0 0 0 0
LexicalReordering0= 0 0 0 0 0 0
LM0= 0
TranslationModel1= 0 0 0 0 0
LexicalReordering1= 0 0 0 0 0 0
LM1= 0

[alternate-weight-setting]
id=fr ignore-ff=LM1,LexicalReordering1 ignore-decoding-path=1
Distortion0= 0.155
LexicalReordering0= 0.074 -0.008 0.002 0.050 0.033 0.042
LM0= 0.152
WordPenalty0= -0.097
TranslationModel0= 0.098 0.065 -0.003 0.060 0.156
id=de ignore-ff=LM0,LexicalReordering0 ignore-decoding-path=0

```

```
LexicalReordering1= 0.013 -0.012 0.053 0.116 0.006 0.080
Distortion0= 0.171
LM0= 0.136
WordPenalty0= 0.060
TranslationModel1= 0.112 0.160 -0.001 0.067 0.006
```

With this model, you can translate:

```
<seg weight-setting=de>Hier ist ein kleines Haus .</seg>
<seg weight-setting=fr>C' est une petite maison . </seg>
```

#### 4.11.6 Modified Moore-Lewis Filtering

When you have a lot of out-of-domain data and you do not want to use all of it, then you can filter down that data to the parts that are more similar to the in-domain data. Moses implements a method called modified Moore-Lewis filtering. The method basically train in-domain and out-of-domain language models, and removes sentence pairs that receive relatively low scores by the in-domain models. For more details, please refer to the following paper:

*Axelrod, Amittai and He, Xiaodong and Gao, Jianfeng: Domain Adaptation via Pseudo In-Domain Data Selection*, Proceedings of the 2011 Conference on Empirical Methods in Natural Language Processing mentioned in Domain Adaptation, pdf<sup>69</sup>, bib<sup>70</sup>.

The Moses implementation is integrated into EMS. You have to specify in-domain and out-of-domain in separate CORPUS sections (you can have more than one of each), and then set in the configuration file which out-of-domain corpora need to be filtered

```
### filtering some corpora with modified Moore-Lewis
#
mml-filter-corpora = giga
mml-before-wa = "-proportion 0.2"
#mml-after-wa = "-proportion 0.2"
```

There are two different places when to do the filtering, either before or after word alignment. There may be some benefits of having out-of-domain data to improve sentence alignment, but that may also be computationally too expensive. In the configuration file, you specify the proportion of the out-of-domain data that will be retained - in the example above 20

*Subsection last modified on October 09, 2015, at 12:33 PM*

<sup>69</sup><http://aclweb.org/anthology/D/D11/D11-1033.pdf>

<sup>70</sup><http://aclweb.org/anthology/D/D11/D11-1033.bib>

## 4.12 Constrained Decoding

### 4.12.1 Contents

- Constrained Decoding (Section 4.12.2)

### 4.12.2 Constrained Decoding

To constrain the output of the decoder to just the reference sentences, add this as a feature:

```
[feature]
....
ConstrainedDecoding path=ref.txt
```

*Subsection last modified on February 13, 2015, at 04:53 PM*

## 4.13 Cache-based Models

### 4.13.1 Contents

- Dynamic Cache-Based Phrase Table (Section 4.13.2)
- Feature Parameters (Section 4.13.2)
- Ageing of the entries (Section 4.13.2)
- Scoring function (Section 4.13.2)
- Annotation (Section 4.13.2)
- Inserting entries (Section 4.13.2)
- Deleting entries (Section 4.13.2)
- File format (Section 4.13.2)
- General notes (Section 4.13.2)
- Dynamic Cache-Based Language Model (Section 4.13.3)
- Feature Parameters (Section 4.13.3)
- Ageing of the entries (Section 4.13.3)
- Scoring function (Section 4.13.3)
- Querying type (Section 4.13.3)
- Annotation (Section 4.13.3)
- Inserting entries (Section 4.13.3)
- Deleting entries (Section 4.13.3)
- File format (Section 4.13.3)
- General notes (Section 4.13.3)

### 4.13.2 Dynamic Cache-Based Phrase Table

A cache-based implementation of phrase table is available; such phrase table can be updated on-the-fly without the need of re-loading data and re-starting the decoder. It is considered **dynamic** in two respects:

- entries can be inserted and deleted at any time
- scores can change over time.

From the perspective of Moses, the cache-based dynamic phrase table (CBPT) is simply an other type of phrase table; hence, during the pre-fetching phase, Moses collects translation options from the CBPT as well as from any other phrase table.

Entries of CBPT can be inserted and deleted by means of xml-based annotations read from input. Furthermore, the CBPT can also be pre-populated loading entries from a file during the Moses start-up.

Each phrase pair of CBPT is associated to an **age**, corresponding to the time it has been inserted in the cache, and its score depends on this age according to a parametrizable scoring function. According to the setting of CBPT, the age of all entries increases by 1 whenever a new entry is inserted, or is kept fixed to its original value. Consequently also the corresponding scores change or are constant over time. See below the section on ageing (Section 4.13.2) for further comments.

In order to activate the CBPT feature, specify parameters and weight for the CBPT in the Moses config file.

```
[feature]
PhraseDictionaryDynamicCacheBased name=CBPT0 num-features=1 [feature-parameters]

[weight]
CBPT0= 1.0
```

Moreover, enable the facility to interpret xml-based tags

```
[xml-input]
inclusive
```

Finally, if you use the CBPT in addition to other phrase tables (one in this example), add an additional translation step

```
[mapping]
0 T 0
1 T 1
```

## Feature Parameters

CBPT exposes the following parameters:

- `name` `string` -- Moses feature name
- `num-features` `int` -- number of score components in phrase table [1, fixed value]
- `cbtn-name` `string` -- internal PBPT name ["default", by default]
- `cbtn-file` `string` -- file name of the entries to pre-populate the cache
- `cbtn-score-type` -- scoring type ["0", by default]
- `cbtn-max-age` -- maximum age of an entry ["1000", by default]
- `cbtn-constant` -- flag to disable ageing of entries ["false", by default]

Moses handles multiple CBPTs; to this purpose, they are identified by an internal parametrizable name to specify in the annotation string (see below). If so, please use different internal name (`cbtn-name`) to refer to different CBPTs. It is worth stressing that the value of `cbtn-name` is an internal parameter of each single CBPT and it is different from the value assigned to the `l`parameter name, which is used at the higher level of Moses to distinguish features.

## Ageing of the entries

The **ageing** of the entries, i.e. the fact that their associated ages are increased after each new insertion, is useful in those scenarios, like news and computer assisted translation, where the domain, lexicon, and/or genre may change over time, and the older entries may be no more valid. Note that an entry which becomes too old, i.e. older than a parametrizable threshold, is removed by the cache. On the other side, having constant and pre-defined ages (and hence scores) can be useful in those scenario, like the translation of manuals of a product, where human-approved lexicons is mostly required. The ageing of the entries, enabled by default, is controlled by the parameter `cbtn-constant` (false by default).

## Scoring function

The score associated to an entry depends on its age 'x' on the basis of following pre-defined functions: Scoring functions are classified into two main classes:

- penalties, which always give a negative score to the entry according to the policy "the less recent, the more penalized"; entries which are not present receive the lowest score (i.e. the highest penalty);
- reward, which always give a positive score if the entry is present in the cache or 0 otherwise.

index	score type	function	
			nnbsp;
0	hyperbola-based penalty	$x^{(-1)} - 1.0$	$\maxAge^{(-1)} - 1.0$
1	power-based penalty	$x^{(-1/4)} - 1.0$	$\maxAge^{(-1/4)} - 1.0$
2	exponential-based penalty	$\exp(x^{(-1)}) / \exp(1.0) - 1.0$	$\exp(\maxAge^{(-1)}) / \exp(1.0) - 1.0$
3	cosine-based penalty	$\cos(3.14/2 * (x-1) / \maxAge) - 1.0$	$\cos(3.14/2 * (\maxAge-1) / \maxAge)$
10	hyperbola-based reward	$x^{(-1)}$	0.0
11	power-based reward	$x^{(-1/4)}$	0.0
12	exponential-based reward	$\exp(x^{(-1)}) / \exp(1.0)$	0.0

<br clear='all' /> The indexes in the first columns identify the scoring function to be set in the configuration file with the parameter `cbtm-score-type`.

### Annotation

The content of the cache of CBPT can be changed feeding the decoder with xml-based annotations from stdin.

The annotation mandatorily contains the fields:

- **type**, which identified the type of features it refers to; the type of any CBPT is **cbtm**
- **id** which identifies which specific CBPT (in case of multiple CBPTs) it refers to; the value is equal to the internal name in the Moses configuration file (**cbtm-name**) ("myCBPT" in the following examples). `<dlt type="cbtm" id="myCBPT" ....`

Note that **dlt** stands for Document Level Translation because originally the dynamic models were intended for that task; **cbtm** stand for Cache-Based Translation Model.

More annotations can be provided in the same line; in this case, annotations are processed sequentially left-to-right.

**Inserting entries** With the following annotation, 3 entries are added contemporarily, i.e. they are associated with the same age 1. Quadruple vertical lines separate phrase pairs; triple vertical lines separate source and target sides of a phrase pair.

```
<dlt type="cbtm" id="myCBPT" cbtm="The crude face of supremacy ||| Le visage rustre de \ \ la domination |||| of supremacy ||| de la domination |||| face ||| visage"
```

Optionally, the word-to-word alignment can be specified between source and target words of any phrase pair. In this case, the word alignment is placed after source and target separated by a triple vertical bars. Word alignments are represented by a list of dash-separated indexes of the source and target words; indexes start from 0. The previous example could become

```
<dlt type="cbtm" id="myCBPT" cbtm="The crude face of supremacy ||| Le visage rustre de \ \ la domination |||| of supremacy ||| de la domination ||| 0-0 0-1 1-2 |||| f
```

In this case, the alignment of only one phrase pair is specified; more precisely the tuple "of supremacy ||| de la domination ||| 0-0 0-1 1-2" means that word "of" is aligned to "de la" and word "supremacy" to "domination".

With the following annotation 3 entries are added sequentially left-to-right. Hence, the most-left insertion ("The crude face of domination ||| Le visage rustre de la domination") is the oldest and the phrase pair is associated to an age of 3, while the right-most insertion ("face|||visage") is the newest and the phrase pair is associated to the age 1.



```
<dlt type="cbtm" id="myCBPT" cbtm="The crude face of supremacy ||| Le visage rustre de \ \ la domination"/><dlt cbtm="of supremacy ||| de la domination ||| 0-0 0-1 1-2"/>
```

Entries to be inserted can be also loaded from file(s). Double vertical lines separate filenames. File format is described below.

```
<dlt type="cbtm" id="myCBPT" cbtm-file="filename-1 || filename-2"/>
```

**Deleting entries** With the following annotation 3 entries are deleting contemporarily. Quadruple vertical lines separate phrase pairs; triple vertical lines separate source and target sides of a phrase pair.

```
<dlt type="cbtm" id="myCBPT" cbtm-clear-option="of supremacy ||| de la domination\ \ \ \ \ The crude face ||| Le visage rustre \ \ \ \ \ face ||| visage"/>
```

Similarly, the same 3 entries are deleted sequentially.

```
<dlt type="cbtm" id="myCBPT" cbtm-clear-option="of supremacy ||| de la domination"/>\ \ \ \ \ <dlt type="cbtm" id="myCBPT" cbtm-clear-option="The crude face ||| Le visage rustre
```

Note that the previous two examples above make no difference because deletion of entries from the CBPT have no impact on the remaining.

With the following annotation all entries associated the specified source phrases are deleted.

```
<dlt cbtm-clear-source="The crude face ||| of supremacy"/>
```

or similarly

```
<dlt cbtm-clear-source="The crude face"/><dlt cbtm-clear-source="of supremacy"/>
```

With either the two annotation below, all entries in CBPT are deleted

```
<dlt cbtm-clear-all=""/>
<dlt cbtm-command="clear"/>
```

**Important:** there is no way to recover the deleted entries.

### File format

[Note that the file format was changed on July 2014.]

CBPT can be also populated by loading entries from file either during the start-up of Moses, or even during decoding using the ad-hoc annotation string. Each line must contain one field with the age (at the beginning) and a list of one or more tuples representing the phrase pairs to insert with the specified age. The tuple must contain the source and the target phrase, and optionally their word-to-word alignment, in the format explained above (see Section "Inserting entries" (Section 4.13.2)).

Age and tuples must be separated by quadruple vertical bars. Source phrase, target phrase and their alignment (if any) must be separated by triple vertical bars.

```
age ||| src_phr ||| trg_phr ||| wa_align ||| src_phr ||| trg_phr ||| wa_align ||| ....
```

Here is an example:

```
1 ||| The crude face ||| Le visage rustre ||| 0-0 1-1 2-2
3 ||| supremacy ||| la domination
2 ||| of supremacy ||| de la domination ||| 0-0 0-1 1-2 ||| crude face ||| visage rustre ||| 0-0 1-1
...
```

Note that the tuple "of supremacy ||| de la domination ||| 0-0 0-1 1-2" means that word "of" is aligned to "de la" and word "supremacy" to "domination"

In case of multiple entries, the last value is considered.

### General notes

At the time being, CBTM (together with CBLM) is the only phrase table implementation in Moses, which can be modified on-the-fly by means of commands passed through the input channel.

Moses is already able to modify its behaviour at run-time, by means of the "xml-input" function. Phrase pairs and scores can be provided to the decoder, and used as exclusive or additional options for the sake of the translation. Nevertheless, this approach has few weaknesses:

- the suggested options refer to a specific input span;
- it is not possible to provide options for overlapping spans;
- the suggested options are at disposal only for the current sentence;
- it has no impact on the language model; hence, if any words within the suggested option is unknown, the language model still penalizes it.

Moses also includes an implementation of the phrase table based on a suffix-array data structure. The phrase table is not created in the training phase; the translation options are instead collected by sampling and scored on-the-fly at translation time, by means of an extremely efficient method of storing and searching the training corpus. Recently, the suffix-array phrase table has been enhanced so that new options can be dynamically added to the training corpus (see here<sup>71</sup> for details). In this way, it can be exploited for the sake of incremental training. Nevertheless, this implementation has few weaknesses:

- as suggested options are merged together with the training corpus, it is not trivial rewarding them with respect to those already existing;
- assuming that the corpus could be quickly extended, the modification would be persistent forever.

CBPT overcomes the drawbacks of the mentioned approaches. In particular,

- the entries inserted in CBPT are available for the translation of the future sentences, but it is also possible to remove them at any time;
- if the available suggested options refer to overlapping spans, the choice of the best alternative is made in the decoding phase by avoiding any potentially dangerous greedy decision;
- thanks to the age-dependent scoring function, it is possible to reward specific translation options, with respect to others.

### 4.13.3 Dynamic Cache-Based Language Model

The cache-based dynamic language model (CBLM) is a novel feature to score the target n-grams of the translation alternatives. This feature is based on caches and can be updated on-the-fly without the need of re-loading data and re-starting the decoder. It is considered **dynamic** in two respects:

- entries can be inserted and deleted at any time
- scores can change over time.

Although CBLM evokes the characteristics of a language model, CBLM is currently implemented as a stateless feature; indeed, it does not support the computation of scores for n-grams across different translation options. This implementation choice is mainly justified by an efficiency reason: the lookup in the dynamic language model is performed only once and only for the n-grams included in the pre-fetched translation options; if we admitted the lookup of all possible n-grams created at translation time, like for a standard LM feature, the computational cost could become unaffordable. In fact, the structure was not developed to achieve extreme speed performance.

The entries of CBLM consist of target n-grams of any length.

<sup>71</sup><http://www.statmt.org/moses/?n=Moses.PhraseDictionaryBitextSampling>

Similarly to CBPT (Section 4.13.2), the entries of CBLM can be inserted and deleted by means of xml-based annotations read from input. Furthermore, the CBLM can also be pre-populated loading entries from a file during the Moses start-up.

Each n-gram of CBLM is associated to an **age**, corresponding to the time it has been inserted in the cache, and its score depends on this age according to a parametrizable scoring function. According to the setting of CBLM, the age of all entries increases by 1 whenever a new entry is inserted, or is kept fixed to its original value. Consequently also the corresponding scores change or are constant over time. See section about the CBPT **ageing** (Section 4.13.2) for some comments about that.

In order to activate the CBLM feature, specify its parameters and weight in the Moses config file.

```
[feature]
DynamicCacheBasedLanguageModel name=CBLM0 num-features=1 [feature-parameters]

[weight]
CBLM0= 1.0
```

Moreover, enable the facility to interpret xml-based tags

```
[xml-input]
inclusive
```

## Feature Parameters

CBLM exposes the following parameters:

- `name string` -- Moses feature name
- `num-features int` -- number of score components in CBLM feature [1, fixed value]
- `cbLM-name string` -- internal CBLM name ["default", by default]
- `cbLM-file string` -- file name of the entries to pre-populate the cache
- `cbLM-score-type` -- scoring type ["0", by default]
- `cbLM-query-type` -- querying type ["0", by default]
- `cbLM-max-age` -- maximum age of an entry ["1000", by default]
- `cbLM-constant` -- flag to disable ageing of entries ["false", by default]

Moses handles multiple CBLMs; to this purpose, they are identified by an internal parametrizable name to specify in the annotation string (see below). If so, please use different internal name (`cbLM-name`) as well as Moses feature name (`name`) to refer to different CBLMs.

### Ageing of the entries

Similarly to CBPT, entries of CBPT are also subject to the ageing. Please refer to the Section about CBPT ageing (Section 4.13.2) for details. The ageing of the CBLM entries, enabled by default, is controlled by the parameter `cb1m-constant` (false by default).

### Scoring function

The score associated to an n-gram depends on its age 'x' on the basis of the same scoring functions of CBPT (Section 4.13.2). The type of the scoring function is set with the parameter `cb1m-score-type`.

### Querying type

CBLM provides two modalities for computing the score of a target n-gram ( $w_1, \dots, w_n$ ) of age  $x$ . In the first modality (`cb1m-query-type=0`), all its substrings of any length ( $w_i, \dots, w_j$ ) ( $1 \leq i \leq j \leq n$ ) are searched in the cache, their scores are computed according to the chosen scoring function, and averaged according to the following formula:

$$\text{avg\_score}(w_1, \dots, w_n) = \frac{1}{n} * (\text{score}(w_1) + \text{score}(w_2) + \dots + \text{score}(w_n)) + \frac{1}{(n-1)} * (\text{score}(w_1, w_2) + \text{score}(w_2, w_3) + \dots + \text{score}(w_{(n-1)}, w_n)) + \dots + \frac{1}{(n-2)} * \dots$$

The average score  $\text{avg\_score}(w_1, \dots, w_n)$  is then associated to the full n-gram. Note that the average score computes a normalization among the number of substrings of a specific length.

In the second modality (`cb1m-query-type=1`), the whole string is looked up in the cache, and its score is computed according to the chosen scoring function.

The querying type is selected by means of the parameter (`cb1m-query-type`), whose default is 0.

### Annotation

The content of the cache of CBLM can be changed feeding the decoder with xml-based annotations from stdin.

The annotation mandatorily contains the fields:

- **type**, which identified the type of feature it refers to; the type of any CBLM is **calm**
- **id** which identifies which specific CBLM (in case of multiple CBPTs) it refers to; the value is equal to the internal name in the Moses configuration file (**cb1m-name**) ("myCBLM" in the following examples). `<dlt type="cb1m" id="myCBLM"`

Note that **dlt** stands for Document Level Translation because originally the dynamic models were intended for that task; **cb1m** stand for Cache-Based Translation Model.

More annotations can be provided in the same line; in this case, annotations are processed sequentially left-to-right.

**Inserting entries** With the following annotation, 3 entries are added contemporarily, i.e. they are associated with the same age 1. Double vertical lines separate n-grams.

```
<dlt type="cblm" id="myCBLM" cblm="Le visage rustre de la domination \\\ || de la domination || visage"/>
```

With the following annotation 3 entries are added sequentially left-to-right. Hence, the most-left insertion ("Le visage rustre de la domination") is the oldest and the n-gram is associated to an age of 3, while the right-most insertion ("visage") is the newest and the n-gram is associated to the age 1.

```
<dlt type="cblm" id="myCBLM" cblm="Le visage rustre de la domination"/>\\ \ <dlt cblm="de la domination"/> <dlt cblm="visage"/>
```

Entries to be inserted can be also loaded from file(s). as follows. Double vertical lines separate filenames. File format is described below.

```
<dlt type="cblm" id="myCBLM" cblm-file="filename-1 || filename-2"/>
```

**Deleting entries** With the following annotation 3 entries are deleting contemporarily. Double vertical lines separate n-grams.

```
<dlt type="cblm" id="myCBLM" cblm-clear-entry ="de la domination || Le visage rustre || visage"/>
```

Similarly, the same 3 entries are deleted sequentially.

```
<dlt type="cblm" id="myCBLM" cblm-clear-entry ="de la domination"/>\\ \ <dlt type="cblm" id="myCBLM" cblm-clear-entry ="Le visage rustre"/>\\ \ <dlt type="cblm" id="n
```

Note that the previous two examples above make no difference because deletion of entries from the CBLM have no impact on the remaining.

With either the two annotation below, all entries in CBLM are deleted

```
<dlt cblm-clear-all=""/>
<dlt cblm-command="clear"/>
```

**Important:** there is no way to recover the deleted entries.

### File format

[Note that the file format was changed on July 2014.]

CBLM can be also populated by loading entries from file either during the start-up of Moses, or even during decoding using the ad-hoc annotation string. Each line must contain one field with the age (at the beginning) and a list of one or more fields with the n-grams to insert with the specified age. Age and n-grams must be separated by double vertical bars.

```
age || n-gram || n-gram || ...
```

Here is an example:

```
1 || Le visage rustre
3 || la domination
2 || de la domination || visage rustre
... || ...
```

In case of multiple entries, the last value is considered.

### General notes

At the time being, CBLM (together with CBPT) is the only feature in Moses, which can be modified on-the-fly by means of commands passed through the input channel. However, as mentioned above, CBLM is not actually a language model, because it does not compute scores for n-grams across different translation options. Furthermore, the computed scores are not related to any probability distribution, and can change over time.

## 4.14 Pipeline Creation Language (PCL)

Building pipelines can be tedious and error-prone. Using Moses scripts to build pipelines can be hampered by the fact that scripts need to be able to parse the output of the previous script. Moving scripts to different positions in the pipeline is tricky and may require a code change! It would be better if the scripts were re-usable without change and users can start to build up a library of computational pieces that can be used in any pipeline in any position.

Since pipelines are widely used in machine translation, and given the problem outlined above, a more convenient and less error prone way of building pipelines quickly, with re-usable components, would aid construction.

A domain specific language called Pipeline Creation Language (PCL) has been developed part of the MosesCore<sup>72</sup> project (European Commission Grant Number 288487 under the 7th Framework Programme). PCL enables users to gather components into libraries, or packages, and re-use them in pipelines. Each component defines inputs and outputs which are checked by the PCL compiler to verify components are compatible with each other.

PCL is a general purpose language that can be used to construct non-recurrent software pipelines. In order to adapt your existing programs and script for use with PCL a Python wrapper must be defined for each program. This builds up a library of components which are combined with others in PCL files. The Python wrapper scripts must implement the following function interface:

- `get_name()` - Returns an object representing the name of the component. The `__str__()` function should be implemented to return a meaningful name.
- `get_inputs()` - Returns the inputs of the component. Components should only be defined with one input port. A list of input names must be returned.
- `get_outputs()` - Returns the outputs of the component. Components should only be defined with one output port. A list of output names must be returned.
- `get_configuration()` - Returns a list of names that represent the static data that shall be used to construct the component.
- `configure(args)` - This function is the component designer's chance to preprocess configuration injected at runtime. The `args` parameter is a dictionary that contains all the configuration provided to the pipeline. This function is to filter out, and optionally preprocess, the configuration used by this component. This function shall return an object containing the configuration necessary to construct this component.
- `initialise(config)` - This function is where the component designer defines the component's computation. The function receives the output object from the `configure()` function and must return a function that takes two parameters, an input object, and a state object. The input object is a dictionary that is received from the previous component in the pipeline, and the state object is the configuration for the component. The returned function should be used to define the component's computation.

Once your library of components have been written they can be combined using the PCL language. A PCL file defines one component which uses other defined components. For example, the following file defines a component that performs tokenisation for source and target files.

---

<sup>72</sup><http://www.statmt.org/mosescore/>



```

#
# Component definition: 2 input ports, 2 output ports
#
#           +-----+
# src_filename -->+      +--> tokenised_src_filename
#           |      |
# trg_filename  -->+      +--> tokenised_trg_filename
#           +-----+
#
import wrappers.tokenizer.tokenizer as tokeniser

component src_trg_tokeniser
inputs (src_filename), (trg_filename)
outputs (tokenised_src_filename), (tokenised_trg_filename)
configuration tokeniser.src.language,
tokeniser.src.tokenisation_dir,
tokeniser.trg.language,
tokeniser.trg.tokenisation_dir,
tokeniser.moses.installation
declare
src_tokeniser := new tokeniser with
tokeniser.src.language -> language,
tokeniser.src.tokenisation_dir -> tokenisation_dir,
tokeniser.moses.installation -> moses_installation_dir
trg_tokeniser := new tokeniser with
tokeniser.trg.language -> language,
tokeniser.trg.tokenisation_dir -> tokenisation_dir,
tokeniser.moses.installation -> moses_installation_dir
as
wire (src_filename -> filename),
(trg_filename -> filename) >>>
(src_tokeniser *** trg_tokeniser) >>>
wire (tokenised_filename -> tokenised_src_filename),
(tokenised_filename -> tokenised_trg_filename)

```

A PCL file is composed of the following bits:

- **Imports:** Optional imports can be specified. Notice that all components must be given an alias, in this case the component `wrappers.tokenizer.tokenizer` shall be referenced in this file by the name `tokeniser`.
- **Component:** This starts the component definition and provides the name. The component's name must be the same as the filename. E.g., a component in `fred.pcl` must be called `fred`.
- **Inputs:** Defines the inputs of the component. The example above defines a component with a two port input. Specifying a comma-separated list of names defines a one port input.

- **Outputs:** Defines the outputs of the component. The example above defines a component with a two port output. Specifying a comma-separated list of names defines a one port output.
- **Configuration:** Optional configuration for the component. This is static data that shall be used to construct components used in this component.
- **Declarations:** Optional declarations of components used in this component. Configuration is used to construct imported components
- **Definition:** The as portion of the component definition is an expression which defines how the construct components are to be combined to create the computation required for the component.

The definition of a component can use the following pre-defined components:

- **first** - This component takes one expression with a one port input and creates a two port input and output component. The provided component is applied only to the first port of the input.
- **second** - This component takes one expression with a one port input and creates a two port input and output component. The provided component is applied only to the second port of the input.
- **split** - Split is a component with one input port and two output ports. The value of the outputs is the input, i.e., splitting the input.
- **merge** - Merge values from the two port input to a one port output. A comma-separated list of **top** and **bottom** keywords subscripted with input names are used to map these values to a new name. E.g., `merge top[a] -> top_a, bottom[b] -> bottom_b` takes the a value of the top input and maps that value to a new name `top_a`, and the b value of the bottom input and maps that value to a new name `bottom_b`.
- **wire** - Wires are used to adapt one component's output to another's input. For wires with one input and output port then the wire mapping is a comma-separated mapping, e.g., `wire a -> next_a, b -> next_b` adapts a one port output component whose outputs are a and b to a one port component whose inputs are `next_a` and `next_b`. For wires with two input and output ports mappings are in comma-separated parentheses, e.g., `wire (a -> next_a, b -> next_b), (c -> next_c, d -> next_d)`. This wire adapts the top input from a to `next_a`, and b to `next_b`, and the bottom input from c to `next_c` and d to `next_d`.
- **if** - Conditional execution of a component can be achieved with the **if** component. This component takes three arguments: a conditional expression, a *then* component and an *else* component. If the condition is evaluated to a truthy value the *then* component is executed, otherwise the *else* component is executed. See the conditional example in the PCL Git repository for an example of usage.

Combinator operators used to compose the pipeline, they are:

- **>>>** - Composition. This operator composes two components. E.g., `a >>> b` creates a component in which a is executed before b.
- **\*\*\*** - Parallel execution. This operator creates a component in which the two components provided are executed in parallel. E.g., `a *** b` creates a component with two input and output ports.
- **&&&** - Parallel execution. The operator creates a component in which two components are executed in parallel from a single input port. E.g., `a &&& b` creates a component with one input port and two output ports.

Examples in the PCL Git repository show the usage of these operators and pre-defined components. Plus an example Moses training pipeline is available in `contrib/arrow-pipelines` directory of the `mosesdecoder` Git repository. Please see `contrib/arrow-pipelines/README` for details of how to compile and run this pipeline.

For more details of how to use PCL please see the latest manual at

```
contrib/arrow-pipelines/python/pcl/documentation/pcl-manual.latest.pdf
```

*Subsection last modified on February 13, 2015, at 04:52 PM*

## 4.15 Obsolete Features

### Contents

- Binary Phrase table (Section 4.15.1)
- Word-to-word alignment (Section 4.15.2)
- Binary Reordering Tables with On-demand Loading (Section 4.15.3)
- Continue Partial Translation (Section 4.15.4)
- Distributed Language Model (Section 4.15.5)
- Installing and Compiling (Section 4.15.5)
- Configuration (Section 4.15.5)
- Example (Section 4.15.5)
- Configuration (Section 4.15.5)
- Create Table (Section 4.15.5)
- Shard Model (Section 4.15.5)
- Create Bloom Filter (Section 4.15.5)
- Integration with Moses (Section 4.15.5)
- Using Multiple Translation Systems in the Same Server (Section 4.15.6)

### 4.15.1 Binary Phrase table

**Note** - You should **NOT** use this phrase-table anymore. The program to create will not be compiled by Moses any longer, and it will not be included in the decoder in the near future.

**Note 2**- Works with phrase-based models only.

You have to convert the standard ASCII phrase tables into the binary format. Here is an example (standard phrase table `phrase-table`, with 4 scores): -}

```
cat phrase-table | LC_ALL=C sort | bin/processPhraseTable \
-ttable 0 0 - -nscores 4 -out phrase-table
```

#### Options:

- `-ttable int int string` -- translation table file, use '-' for stdin
- `-out string` -- output file name prefix for binary translation table
- `-nscores int` -- number of scores in translation table

If you just want to convert a phrase table, the two integers in the `-ttable` option do not matter, so use 0's.

**Important:** If your data is encoded in UTF8, make sure you set the environment variable with the `LC_ALL=C` before sorting. If your phrase table is already sorted, you can skip that.

The output files will be:

```
phrase-table.binphr.idx
phrase-table.binphr.srctree
phrase-table.binphr.srcvoc
phrase-table.binphr.tgtdata
phrase-table.binphr.tgtvoc
```

In the Moses configuration file, specify only the file name stem `phrase-table` as phrase table and set the type to 1, i.e.:

```
[feature]
PhraseDictionaryBinary path=phrase-table ...
```

### 4.15.2 Word-to-word alignment

**This is on by default, so most of these arguments are not relevant**

There are 2 arguments to the decoder that enables it to print out the word alignment information

```
-alignment-output-file [file]
```

print out the word alignment for the best translation to a file.

```
-print-alignment-info-in-n-best
```

print the word alignment information of each entry in the n-best list as an extra column in the n-best file.

Word alignment is included in the phrase-table by default (as of November 2012). To exclude them, add

```
--NoWordAlignment
```

as an argument to the score program.

When binarizing the phrase-table, the word alignment is also included by default. To turn this behaviour off for the phrase-based binarizer: ~~processPhraseTable -no-alignment-info ...~~ Or

```
processPhraseTableMin -no-alignment-info ....
```

(For the compact phrase-table representation).

There is no way to exclude word alignment information from the chart-based binarization process.

**Phrase-based binary format** When word alignment information is stored, the two output files ".srctree" and ".tgtdata" will end with the suffix ".wa".

**Note:** The argument

```
-use-alignment-info
-print-alignment-info
```

has been deleted from the decoder. `-print-alignment-info` did nothing. `-use-alignment-info` is now inferred from the arguments

```
-alignment-output-file
-print-alignment-info-in-n-best
```

Additionally, the

```
-include-alignment-in-n-best
```

has been renamed

```
-include-segmentation-in-n-best
```

to reflect what it actually does.

The word alignment **MUST** be enabled during binarization, otherwise the decoder will

1. complain
2. carry on blindly but doesn't print any word alignment

#### 4.15.3 Binary Reordering Tables with On-demand Loading

The reordering tables may be also converted into a binary format. The command is slightly simpler:

```
mosesdecoder/bin/processLexicalTable -in reordering-table -out reordering-table
```

The file names for input and output are typically the same, since the actual output file names have similar extensions to the phrase table file names.

#### 4.15.4 Continue Partial Translation

**Alert: This functionality has been removed as of May 2013.**

This option forces Moses to start generating the translation from a non-empty hypothesis. This can be useful in situations, when you have already translated some part of the sentence and want to get a suggestion or an n-best-list of continuations.

Use `-continue-partial-translation` (`-cpt`) to activate this feature. With `-cpt`, Moses accepts also a special format of the input: three parameters delimited by the triple bar (`|||`). The first parameter is the string of output produced so far (used for LM scoring). The second parameter is the coverage vector of input words are already translated by the output so far, written as a string of "1"s and "0"s of the same length as there are words in the input sentence. The third parameter is the source sentence.

Example:

```
% echo "that is ||| 11000 ||| das ist ein kleines haus" | mooses -f mooses.ini -continue-partial-translation
that is a small house

% echo "that house ||| 10001 ||| das ist ein kleines haus" | mooses -f mooses.ini -continue-partial-translation
that house is a little
```

If the input does not fit to this pattern, it is treated like normal input with no words translated yet.

This type of input is currently **not** compatible with factored models or confusion networks. The standard non-lexicalized distortion works but more or less as one would expect (note that some input coverage vectors may prohibit translation under low distortion limits). The lexicalized reordering has not been tested.

### Options

- `-continue-partial-translation (-cpt)` -- activate the feature

#### 4.15.5 Distributed Language Model

##### **NB - THIS HAS BEEN REMOVED FROM MOSES (HIEU)**

In most cases, MT output improves significantly when more data is used to train the Language Model. More data however produces larger models, and it is very easy to produce a model which cannot be held in the main memory of a single machine. To overcome this, the Language Model can be distributed across many machines, allowing more data to be used at the cost of a performance overhead.

Support for Distributed Language Models in Moses are built on top of a bespoke distributed map implementation called DMap. DMap and support for Distributed Language Models are still in beta, and any feedback or bug reports are welcomed.

### Installing and Compiling

Before compiling Moses with DMap support, you must configure your DMap setup (see below). Once that has been done, run Moses' `configure` script with your normal options and `--with-dmaplm=<path-to-dmap>`, then the usual `make`, `make install`.

### Configuration

Configuring DMap is at the moment, a very crude process. One must edit the `src/DMap/Config.cpp` file by hand and recompile when making any changes. With the configuration being compiled in, this also means that once it is changed, any programs statically linked to DMap will have to be recompiled too. The file `src/DMap/Config.cpp` provides a good example configuration which is self explanatory.

### Example

In this example scenario, we have a Language Model trained on the `giga4` corpus which we wish to host across 4 servers using DMap. The model is a 5-gram model, containing roughly 210 million ngrams; the probabilities and backoff weights of ngrams will be uniformly quantised to 5 bit values.

**Configuration** Here is an example `Config.cpp` for such a set up:

```
config->setShardDirectory("/home/user/dmap");
config->addTableConfig(new TableConfigLossyDoubleHash(
"giga4",    // name of table
283845991, // number of cells (approx 1.23 * number of ngrams)
64,        // number of chunks (not too important, leave at 64)
(((uint64_t)1 << 61) - 1), // universal hashing P parameter
5789372245 % (((uint64_t)1 << 61) - 1), // universal hashing a parameter
3987420741 % (((uint64_t)1 << 61) - 1), // universal hashing b parameter
"/home/user/dmap/giga4.bf",
16,        // num_error_bits (higher -> fewer collisions but more memory)
10,        // num_value_bits (higher -> more accurate probabilities
// and backoff weights but more memory)
20));      // num_hashes (higher ->
// config->addStructConfig(new StructConfigLanguageModelBackoff(
"giga4",    // struct name
"giga4",    // lm table name
5,         // lm order
5,         // num logprob bits (these fields should add up to the number
// of value bits for the table)
5));      // num backoff bits
config->addServerConfig(new ServerConfig("server0.some.domain", 5000));
config->addServerConfig(new ServerConfig("server1.some.domain", 5000));
config->addServerConfig(new ServerConfig("server2.some.domain", 5000));
config->addServerConfig(new ServerConfig("server3.some.domain", 5000));
```

Note that the shard directory should be on a shared file system all Servers can access.

**Create Table** The command:

```
create_table giga4
```

will create the files for the shards.



**Shard Model** The model can now be split into chunks using the *shard* utility:

```
shard giga4 /home/user/dmap/giga4.arpa
```

**Create Bloom Filter** A Bloom filter is a probabilistic data structure encoding set membership in an extremely space efficient manner. When querying whether a given item is present in the set they encode, they can produce an error with a calculable probability. This error is one sided in that they can produce false positives, but never false negatives. To avoid making slow network requests, DMap keeps a local Bloom filter containing the set of ngrams in the Language Model. Before making a network request to get the probability of an ngram, DMap first checks to see if the ngram is present in the Bloom filter. If is not, then we know for certain the ngram is not present in the model and therefore not worth issuing a network request for. However, if the ngram is present in the filter, it might actually be in the model, or the filter may have produced a false positive.

To create a Bloom filter containing the ngrams of the Language Model, run this command:

```
ngrams < /home/user/dmap/giga4.arpa | mkbfs 134217728 2100000000 /home/user/dmap/giga4.bf
```

**Integration with Moses** The structure within DMap Moses should use as the Language Model should be put into a file, in this case at `/home/user/dmap/giga4.conf`:

```
giga4  
false
```

Note that if for testing or experimentation purposes you would like to have the whole model on the local machine instead of over the network, change the false to true. You must have sufficient memory to host the whole model, but decoding will be significantly faster.

To use this, put the following line in your `moses.ini` file:

```
11 0 0 5 /home/user/dmap/giga4.conf
```

### 4.15.6 Using Multiple Translation Systems in the Same Server

**Alert:** This functionality has been removed as of May 2013. A replacement is [Alternative Weight Settings](http://www.statmt.org/poses/?n=Advanced.AdvancedFeatures?action=edit)

The Moses server is now able to load multiple translation systems within the same server, and the client is able to decide which translation system that the server should use, on a per-sentence basis. The client does this by passing a `system` argument in the `translate` operation.

One possible use-case for this multiple models feature is if you want to build a server that translates both French and German into English, and uses a large English language model. Instead of running two copies of the Moses server, each with a copy of the English language model in memory, you can now run one Moses server instance, with the language model in memory, thus saving on RAM.

To use the multiple models feature, you need to make some changes to the standard Moses configuration file. A sample configuration file can be found here<sup>73</sup>.

The first piece of extra configuration required for a multiple models setup is to specify the available systems, for example

```
[translation-systems]
de D 0 R 0 L 0
fr D 1 R 1 L 1
```

This specifies that there are two systems (`de` and `fr`), and that the first uses decode path 0, reordering model 0, and language model 0, whilst the second uses the models with id 1. The multiple decode paths are specified with a stanza like

```
[mapping]
0 T 0
1 T 1
```

which indicates that the 0th decode path uses the 0th translation model, and the 1st decode path uses the 1st translation model. Using a language model specification like

```
[lmodel-file]
0 0 5 /disk4/translation-server/models/interpolated-lm
0 0 5 /disk4/translation-server/models/interpolated-lm
```

<sup>73</sup><http://www.statmt.org/poses/img/poses-en.ini>

means that the same language model can be used in two different systems with two different weights, but Moses will only load it once. The weights sections of the configuration file must have the correct numbers of weights for each of the models, and there must be a word penalty and linear distortion weight for each translation system. The lexicalised reordering weights (if any) must be specified in the `[weight-lr]` stanza, with the distortion penalty in the `[weight-d]` stanza.

*Subsection last modified on February 13, 2015, at 04:55 PM*

## 4.16 Sparse Features

Sparse feature functions in Moses allow for thousands of features that follow a specific pattern, typically lexical instantiations of a general feature function. Take for instance the **target word insertion** feature function, which allows the training of lexical indicators for any word (say, *the* or *fish*). Each lexicalized instantiation has its own feature weight, which is typically trained during tuning. Inserting a *the* should be fine, inserting the word *fish* not so much, and the learned feature weight should reflect this.

In Moses, all feature functions can contain sparse features and dense features. The number of dense feature has to be specified in advance in `moses.ini` file, e.g.,

```
KENLM num-features=1 ...
```

The decoder doesn't have to know whether a feature function contains sparse features. And by definition, the number of sparse features is not specified beforehand.

Sparse lexical features require a special weight file that contains the weight for each instantiation of a feature.

The weight file has to be specified in the `moses.ini` file:

```
[weight-file]
path/sparse-weights
```

This file may look like:

```
twi_fish -0.5
twi_of -0.001
[...]
```

By convention, the format for sparse features is

```
InstanceName_SparseFeatureName
```

Of course, you want to learn these feature weights during tuning, which requires the use of either PRO or kbMIRA - it does not work with plain MERT.

#### 4.16.1 Word Translation Features

There are three types of lexical feature function:

- word translation feature, which indicates if a specific source word was translated as a specific target word
- target word insertion, which indicates if a specific target word has no alignment point (aligns to no source word in the word alignment stored for the phrase pair)
- source word deletion, which indicates if a specific source word has no alignment point

##### Specification in `moses.ini`

The following lines need to be added to the configuration file:

```
[feature]
TargetWordInsertionFeature factor=FACTOR [path=FILE]
SourceWordDeletionFeature factor=FACTOR [path=FILE]
WordTranslationFeature input-factor=FACTOR output-factor=FACTOR \
[source-path=FILE] [target-path=FILE]-path= \
simple=1 source-context=0 target-context=0
```

Note that there is no corresponding weight setting for these features.

The optional word list files (one token per line) restrict the feature function to the specified words. If no word list file is specified, then features for all words are generated.

##### Specification with `experiment.perl`

Word translation features can be specified as follows:

```
TRAINING:sparse-features = \
"target-word-insertion top 50, source-word-deletion top 50, \
word-translation top 50 50"
```

This specifications includes

- target word insertion features for the top 50 most frequent target words
- source word deletion features for the top 50 most frequent source words
- word translation features for the top 50 most frequent target words and top 50 most frequent source words

Instead of top 50, you can also specify all when you do not want to have a restricted word list.

Moreover, for the word translation feature, by specifying factor 1-2, you can change input and output factor for the feature. For the deletion and insertion features, there is only one factor to specify, e.g., factor 1.

### 4.16.2 Phrase Length Features

The phrase length feature function creates three features for each phrase pair:

- the length of the source phrase (in tokens)
- the length of the target phrase
- the pair of the two values above

For instance, when the phrase *ein Riesenhaus* is translated into *a giant house*, then the three features p1\_s2 (2 source words), p1\_t3 (3 target words), and p1\_2,3 (2 source words into 3 target words) are triggered.

#### Specification in `moses.ini`

The following lines need to be added to the configuration file:

```
[feature]
PhraseLengthFeature
```

#### Specification with `experiment.perl`

The inclusion of the phrase length feature is similar to the word translation feature:

```
TRAINING:sparse-features = "phrase-length"
```

In case of using both the phrase length feature and the word translation features, you will need to include them in the same line.

### 4.16.3 Domain Features

Domain features flag each phrase pair on in which domain (or more accurately: which subset of the training data) they occur in.

#### Specification in `moses.ini`

Domain features are part of the phrase table, there is no specific support for his particular type of feature function. A sparse phrase table may include any other arbitrary features. Each line in the phrase table has to contain an additional field that lists the feature name and its log-probability value.

For example, the following phrase pair contains the domain feature flagging that the phrase pair occurred in the `europarl` part of the training corpus:

```
das Haus ||| the house ||| 0.8 0.5 0.8 0.5 2.718 ||| 0-0 1-1 \
||| 5000 5000 2500 ||| dom_europarl 1
```

If a phrase table contains sparse features, then this needs to be flagged in the configuration file by adding the word `sparse` after the phrase table file name.

#### Specification with `experiment.perl`

```
TRAINING:domain-features = "[sparse ](indicator|ratio|subset)"
```

There are various settings for domain adaptation features. It requires a domain file that indicates at which lines in the parallel corpus cover lines that stem from different [CORPUS] blocks (default, when used in `experiment.perl`, but a different domain-file can be also specified).

These features may included as sparse features or as core features in the phrase table, depending in having the prefix `Sparse` in the parameter.

There are three kind of features:

- Indicator: Each phrase pair is marked if it occurs in a specific domain
- Ratio: Each phrase pair is marked with  $\exp(0) \leq \log(r) \leq \exp(1)$  float feature depending on the ratio  $r$  how often it occurs in corpus  $r$ .
- Subset: Similar to the indicator feature, but if a phrase pair occurs in multiple domains if is marked with these domains in one feature
- Bin (not implemented, the idea is the count bin feature mentioned below but with marking count intervals for each domain).

#### 4.16.4 Count Bin Features

The frequency of a phrase pair in the training data may be a useful to determine its reliability. The count bin features are integrated into the phrase table, just like the domain features, so please check that documentation.

##### Specification with `experiment.perl`

The counts of phrase pairs get very sparse for frequent phrases. There are just not that many phrase pairs that occur exactly 634,343 times. Hence, we bin phrase pairs counts, for instance phrase pairs that occur once, twice, three to nine times, and more often.

In `experiment.perl` this is accomplished with an additional switch in `score settings`. For the example above this looks like this:

```
TRAINING:score-settings = "--[Sparse]CountBinFeature 1 2 3 10"
```

Based on the values that are given, different indicator features are included, depending on which interval count the phrase pair falls, e.g., ]2;3] = third bin.

#### 4.16.5 Bigram Features

TODO

#### 4.16.6 Soft Matching Features

Models with target syntax require an exact match between nonterminals in a rule and the left-hand-side label of rules that can be substituted into it. With the following rules, a model could be used to decode 'she slept here', but not 'she slept on the floor'.

```
S --> she slept AVP1 ||| sie schlief AVP1
AVP --> here ||| hier
PP --> on the floor ||| auf dem boden
```

With soft matching, we can allow substitutions of nonterminals even if they do not match.

##### Specification in `moses.ini`

The following lines need to be added to the configuration file:

```
[feature]
SoftMatchingFeature path=FILE
```

with FILE containing a user-defined list of allowed substitutions. For the example above, the file needs to contain the following line:

```
PP AVP
```

Each substitution (even exact matches) triggers a sparse feature which can be used to prefer some substitutions over others.

The SoftMatchingFeature operates on the target-side labels and is not (yet) implemented for the Scope3 and OnDisk phrase tables.

*Subsection last modified on April 04, 2014, at 04:06 PM*

## 4.17 Translating Web pages with Moses

*(Code and documentation written by Herve Saint-Amand.)*

We describe a small set of publicly available Perl scripts that provide the mechanisms to translate a Web page by retrieving it, extracting all sentences it contains, stripping them of any font style markup, translating them using the Moses system, re-inserting them in the document while preserving the layout of the page, and presenting the result to the user, providing a seamless translation system comparable to those offered by Google, BabelFish and others.

### 4.17.1 Introduction

#### **Purpose of this program**

Moses is a cutting-edge machine translation program that reflects the latest developments in the area of statistical machine translation research. It can be trained to translate between any two languages, and yields high quality results. However, the Moses program taken alone can only translate plain text, i.e., text stripped of any formatting or style information (as in .txt files). Also, it only deals with a single sentence at a time.

A program that can translate Web pages is a very useful tool. However, Web pages contain a lot of formatting information, indicating the color, font and style of each piece of text, along with its position in the global layout of the page. Most Web pages also contain more than one sentence or independent segment of text. For these reasons a Web page cannot be fed directly to Moses in the hope of obtaining a translated copy.



The scripts described in this document implement a Web page translation system that, at its core, relies on Moses for the actual translation task. The scripts' job, given a Web page to translate, is to locate and extract all strings of text in the page, split paragraphs into individual sentences, remove and remember any style information associated with the text, send the normalized, plain-text string to Moses for translation, re-apply the style onto the translated text and re-insert the sentence at its place in the original page structure, (hopefully) resulting in a translation of the original.

### **A word of warning**

These scripts are a proof-of-concept type of demonstration, and should not be taken for more than that. They most probably still contain bugs, and possibly even security holes. They are not appropriate for production environments.

### **Intended audience and system requirements**

This document is meant for testers and system administrators who wish to install and use the scripts, and/or to understand how they work.

Before starting, the reader should ideally possess basic knowledge of:

- UNIX-type command-line environments
- TCP/IP networking (know what a hostname and a port are)
- how to publish a Web page using a CGI script on an Apache server
- how to configure and operate the Moses decoder

and have the following resources available:

- an Apache (or similar) Web server
- the possibility of running CPU- and memory-intensive programs, either on the Web server itself (not recommended), or on one or several other machines that can be reached from the Web server
- Moses installed on those machines

### Overview of the architecture

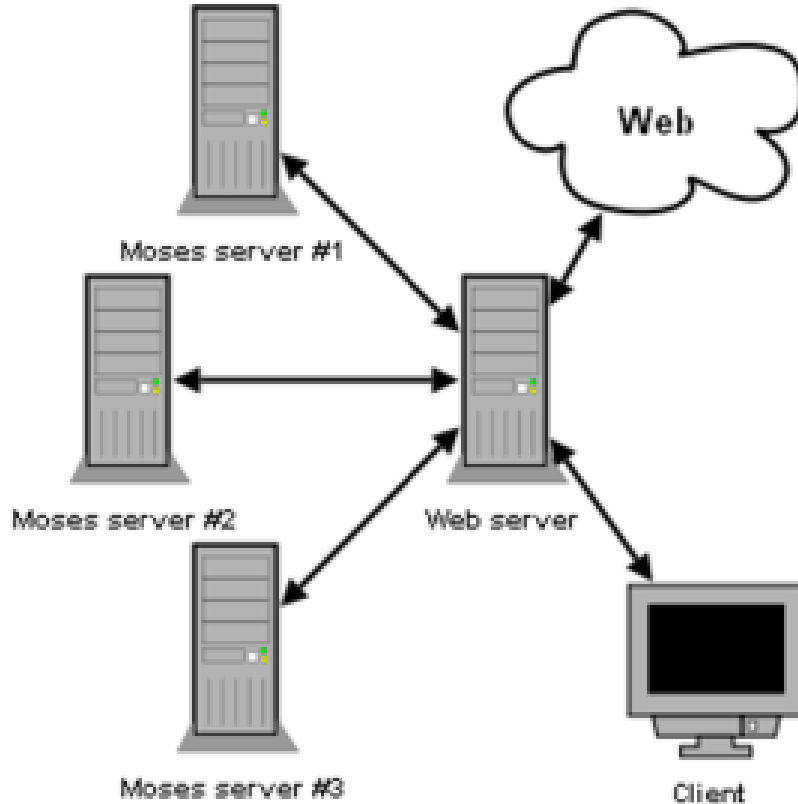

The following is a quick overview of how the whole system works. An attempt at illustrating the architecture is in the figure above. File names refer to files available from an Git repository, as explained in the download section.

1. The Moses system is installed and configured on one or several computers that we designate as **Moses servers**.
2. On each Moses server, a daemon process, implemented by `daemon.pl`, accepts network connections on a given port and copies everything it gets from those connections straight to Moses, sending back to the client what Moses printed back. This basically *plugs* Moses directly onto the network.
3. Another computer, which we designate as the **web server**, runs Apache (or similar) Web server software.
4. Through that server, the CGI scripts discussed in this document (`index.cgi`, `translate.cgi` and supporting files) are served to the client, providing the user interface to the system. It is a simple matter to configure `translate.cgi` so that it knows where the Moses servers are located.
5. A client requests `index.cgi` via the Web server. A form containing a textbox is served back, where the user can enter a URL to translate.
6. That form is submitted to `translate.cgi`, which does the bulk of the job. It fetches the page from the Web, extracts translatable plain text strings from it, sends those to the Moses servers for translation, inserts the translations back into the document, and serves the document back to the client. It adjusts links so that if any one is clicked in the translated document, a translated version will be fetched rather than the document itself.

The script containing all the interesting code, `translate.cgi`, is heavily commented, and programmers might be interested in reading it.

### Mailing list

Should you encounter problems you can't solve during the installation and operation of this program, you can write to the moses support mailing list at `moses-support@mit.edu`. Should you not encounter problems, the author (whose email is found in the source file headers) would be astonished to hear about it.

## 4.17.2 Detailed setup instructions

### Obtaining a copy of the scripts

The scripts are stored in the `contrib/web` directory in the Moses distribution.

### Setting up the Web server

The extracted source code is ready to be run, there is no installation procedure that compiles or copies files. The program is entirely contained within the directory that was downloaded from Github. It now needs to be placed on a Web server, in a properly configured location such that the CGI scripts (the two files bearing the `.cgi` extension) are executed when requested from a browser.

For instance, if you are on a shared Web server (e.g., a server provided by your university) and your user directory contains a directory named `public_html`, placing the `moses-web` directory inside `public_html` should make it available via the Web, at an address similar to `http://www.dept.uni/~you/moses-web/`.

### Troubleshooting

- **404 Not Found** Perhaps the source code folder is not in the right location? Double-check the directory names. See if the home folder (parent of `moses-web` itself) is reachable. Ask your administrator.
- **403 Forbidden**, or you see the Perl source code of the script in your browser} The server is not configured to execute CGI scripts in this directory. Move `moses-web` to the `cgi-bin` subdirectory of your Web home, if it exists. Create a `.htaccess` file in which you enable the `ExecCGI` option (see the Apache documentation).
- **Internal server error** Perhaps the scripts do not have the right permissions to be executed. Go in `moses-web` and type the command `chmod 755 *cgi`.

The scripts are properly installed once you can point your browser at the correct URL and you see the textbox in which you should enter the URL, and the 'Translate' button. Pressing the button won't work yet, however, as the Moses servers need to be installed and configured first.

## Setting up the Moses servers

You now need to install Moses and the `daemon.pl` script on at least one machine.

### Choosing machines for the Moses servers

Running Moses is a slow and expensive process, at least when compared to the world of Web servers where everything needs to be lightweight, fast and responsive. The machine selected for running the translator should have a recent, fast processor, and as many GBs of memory as possible (see the Moses documentation for more details).

Technically, the translations could be computed on the same machine that runs the Web server. However, the loads that Moses places on a system would risk seriously impacting the performance of the Web server. For that reason, we advise not running Moses on the same computer as the Web server, especially not if the server is a shared server, where several users host their files (such as Web servers typically provided by universities). In case of doubt we recommend you ask your local administrator.

For the sake of responsiveness, you may choose to run Moses on several machines at once. The burden of translation will then be split equally among all the hosts, thus more or less dividing the total translation time by the number of hosts used. If you have several powerful computers at your disposal, simply repeat the installation instructions that follow on each of the machines independently.

The main translation script, which runs on the Web server, will want to connect to the Moses servers via TCP/IP sockets. For this reason, the Moses servers must be reachable from the Web server, either directly or via SSH tunnels or other proxy mechanisms. Ultimately the translation script on the Web server must have a hostname/port address it can connect to for each Moses server.

### Installing the scripts

**Install Moses** For each Moses server, you will need to install and configure Moses for the language pair that you wish to use. If your Moses servers are all identical in terms of hardware, OS and available libraries, installing and training Moses on one machine and then copying the files over to the other ones should work, but your mileage may vary.

**Install `daemon.pl`** Once Moses is working, check out, on each Moses server, another copy of the `moses-web` source directory by following again the instructions in the download section. Open `bin/daemon.pl`, and edit the `$MOSES` and `$MOSES_INI` paths to point to the location of your moses binary and your `moses.ini` configuration file.

**Choose a port number** Now you must choose a port number for the daemon process to listen on. Pick any number between 1,024 and 49,151, ideally not a standard port for common programs and protocols to prevent interference with other programs (i.e., pick a port not mentioned in your `/etc/services` file).

**Start the daemon** To activate a Moses server, simply type, in a shell running on that server:

```
./daemon.pl <hostname> <port>
```

where `<hostname>` is the name of the host you're typing this on (found by issuing the `hostname` command), and `<port>` is the port you selected. It may be misleading that despite its name, this program does not fork a background process, it is the background process itself. To truly launch the process in the background so that it continues running after the shell is closed, this command might be more useful:

```
nohup ./daemon.pl <hostname> <port> &
```

The `bin/start-daemon-cluster.pl` script distributed with this program provides an automation mechanism that worked well in the original setup on the University of Saarland network. It was used to start and stop the Moses servers all at once, also setting up SSH tunneling on startup. Because it is very simple and trimmed to the requirements of that particular installation, we do not explain its use further here, but the reader might find inspiration in reading it.

**Test the Moses servers** The daemon should now be listening on the port you chose. When it receives a connection, it will read the input from that connection one line at a time, passing each line in turn to Moses for translation, and printing back the translation followed by a newline.

If you have the NetCat tool installed, you can test whether it worked by going to a shell on the Web server and typing `echo "Hello world" | nc <hostname> <port>`, replacing `Hello world` by a phrase in your source language if it is not English, and `<hostname>` and `<port>` by the values pointing to the Moses server you just set up. A translation should be printed back.

**Configure the tokenizer** The `translate.cgi` script uses external tokenizer and detokenizer scripts. These scripts adapt their regular expressions depending on the language parsed, and so tokenizing is improved if the correct language is selected. This is done by opening `translate.cgi` with your favourite text editor, and setting `$INPUT_LANG` and `$OUTPUT_LANG` to the appropriate language codes. Currently the existing language codes are the file extensions found in the `bin/nonbreaking_prefixes` directory. If yours are not there, simply use `en -- end-of-sentence` detection may then be suboptimal, and translation quality may be impacted, but the system will otherwise still function.

**Configure the Web server to connect to the Moses servers** The last remaining step is to tell the frontend Web server where to find the backend Moses servers. Still in `translate.cgi`, set the `@MOSES_ADDRESSES` array to the list of `hostname:port` strings identifying the Moses servers.

Here is a sample valid configuration for three Moses servers named `server01`, `server02` and `server03`, each with the daemon listening on port 7070:

```
my @MOSES_ADDRESSES = ("server01:7070", "server02:7070", "server03:7070");
```

**Stopping the daemons once done** The daemon processes continuously keep a copy of Moses running, so they consume memory even when idle. For this reason, we recommend that you stop them once they are not needed anymore, for instance by issuing this command on each Moses server: `killall daemon.pl`

*Subsection last modified on July 28, 2013, at 08:01 AM*

# 5

## Training Manual

### 5.1 Training

#### 5.1.1 Training process

We will start with an overview of the training process. This should give a feel for what is going on and what files are produced. In the following, we will go into more details of the options of the training process and additional tools.

The training process takes place in nine steps, all of them executed by the script

```
train-model.perl
```

The nine steps are

1. Prepare data (45 minutes)
2. Run GIZA++ (16 hours)
3. Align words (2:30 hours)
4. Get lexical translation table (30 minutes)
5. Extract phrases (10 minutes)
6. Score phrases (1:15 hours)
7. Build lexicalized reordering model (1 hour)
8. Build generation models
9. Create configuration file (1 second)

If you are running on a machine with multiple processors, some of these steps can be considerably sped up with the following option:

```
--parallel
```

The run times mentioned in the steps refer to a recent training run on the 751'000 sentence, 16 million word German-English Europarl corpus, on a 3GHz Linux machine.

If you wish to experiment with translation in both directions, step 1 and 2 can be reused, starting from step 3 the contents of the model directory get direction-dependent. In other words run steps 1 and 2, then make a copy of the whole experiment directory and continue two trainings from step 3.

### 5.1.2 Running the training script

For an standard phrase model, you will typically run the training script as follows.

Run the training script:

```
train-model.perl -root-dir . --corpus corpus/euro --f de --e en
```

There should be two files in the *corpus/* directory called *euro.de* and *euro.en*. These files should be sentence-aligned halves of the parallel corpus. *euro.de* should contain the German sentences, and *euro.en* should contain the corresponding English sentences.

More on the training parameters (Section 8.3) at the end of this manual. For corpus preparation, see the section on how to prepare training data (Section 5.2).

*Subsection last modified on May 04, 2010, at 11:05 PM*

## 5.2 Preparing Training Data

Training data has to be provided sentence aligned (one sentence per line), in two files, one for the foreign sentences, one for the English sentences:

```
>head -3 corpus/euro.*
==> corpus/euro.de <==
wiederaufnahme der sitzungsperiode
ich erkläre die am donnerstag , den 28. märz 1996 unterbrochene
sitzungsperiode des europaeischen parlaments fuer wiederaufgenommen .
begruessung

==> corpus/euro.en <==
resumption of the session
i declare resumed the session of the european parliament adjourned
on thursday , 28 march 1996 .
welcome
```

A few other points have to be taken care of:



- unix commands require the environment variable `LC_ALL=C`
- one sentence per line, no empty lines
- sentences longer than 100 words (and their corresponding translations) have to be eliminated (note that a shorter sentence length limit will speed up training)
- everything lowercased (use `lowercase.perl`)

### 5.2.1 Training data for factored models

You will have to provide training data in the format

```
word0factor0|word0factor1|word0factor2 word1factor0|word1factor1|word1factor2 ...
```

instead of the un-factored

```
word0 word1 word2
```

### 5.2.2 Cleaning the corpus

The script `clean-corpus-n.perl` is small script that cleans up a parallel corpus, so it works well with the training script.

It performs the following steps:

- removes empty lines
- removes redundant space characters
- drops lines (and their corresponding lines), that are empty, too short, too long or violate the 9-1 sentence ratio limit of GIZA++

The command syntax is:

```
clean-corpus-n.perl CORPUS L1 L2 OUT MIN MAX
```

For example: `clean-corpus-n.perl raw de en clean 1 50` takes the corpus files `raw.de` and `raw.en`, deletes lines longer than 50, and creates the output files `clean.de` and `clean.en`.

## 5.3 Factored Training

For training a factored model, you will specify a number of additional training parameters:

```
--alignment-factors FACTORMAP
--translation-factors FACTORMAPSET
--reordering-factors FACTORMAPSET
--generation-factors FACTORMAPSET
--decoding-steps LIST
```

### Alignment factors

It is usually better to carry out the word alignment (step 2-3 of the training process) on more general word representations with rich statistics. Even successful word alignment with words stemmed to 4 characters have been reported. For factored models, this suggests that word alignment should be done only on either the surface form or the stem/lemma.

Which factors are used during word alignment is set with the `--alignment-factors` switch. Let us formally define the parameter syntax:

- FACTOR = [ 0 - 9 ]+
- FACTORLIST = FACTOR [ , FACTOR ]\*
- FACTORMAP = FACTORLIST - FACTORLIST

The switch requires a FACTORMAP as argument, for instance `0-0` (using only factor 0 from source and target language) or `0,1,2-0,1` (using factors 0, 1, and 2 from the source language and 0 and 1 from the target language).

Typically you may want to train the word alignment using surface forms or lemmas.

### 5.3.1 Translation factors

The purpose of training factored translation model is to create one or more translation tables between a subset of the factors. All translation tables are trained from the same word alignment, and are specified with the switch `--translation-factors`.

To define the syntax, we have to extend our parameter syntax with

- FACTORMAPSET = FACTORMAP[+FACTORMAP]\*

since we want to specify multiple mappings.

One example is `--translation-factors 0-0+1-1,2`, which create the two tables

```
phrase-table.0-0.gz
phrase-table.1-1,2.gz
```

### 5.3.2 Reordering factors

Reordering tables can be trained with `--reordering-factors`. Syntax is the same as for translation factors.

### 5.3.3 Generation factors

Finally, we also want to create generation tables between target factors. Which tables to generate is specified with `--generation-factors`, which takes a `FACTORMAPSET` as a parameter. Note that this time the mapping is between target factors, not between source and target factors.

One example is `--generation-factors 0-1` which creates a generation table between factor 0 and 1.

### 5.3.4 Decoding steps

The mapping from source words in factored representation into target words in factored representation takes place in a number of mapping steps (either using a translation table or a generation table). These steps are specified with the switch `--decoding-steps LIST`.

For example `--decoding-steps t0,g0,t1,t2,g1` specifies that mapping takes place in form of an initial translation step using translation table 0, then a generation step using generation table 0, followed by two translation steps using translation tables 1 and 2, and finally a generation step using generation table 1. (The specific names `t0`, `t1`, ... are automatically assigned to translation tables in the order you define them with `--translation-factors`, and likewise for `g0` etc.)

It is possible to specify multiple decoding paths, for instance by `--decoding-steps t0,g0,t1,t2,g1:t3`, where colons separate the paths. Translation options are generated from each decoding path and used during decoding.

*Subsection last modified on July 28, 2013, at 09:27 AM*

## 5.4 Training Step 1: Prepare Data

The parallel corpus has to be converted into a format that is suitable to the GIZA++ toolkit. Two vocabulary files are generated and the parallel corpus is converted into a numberized format.

The vocabulary files contain words, integer word identifiers and word count information:

```

==> corpus/de.vcb <==
1      UNK      0
2      ,        928579
3      .        723187
4      die      581109
5      der      491791
6      und      337166
7      in       230047
8      zu       176868
9      den      168228
10     ich      162745

==> corpus/en.vcb <==
1      UNK      0
2      the      1085527
3      .        714984
4      ,        659491
5      of       488315
6      to       481484
7      and      352900
8      in       330156
9      is       278405
10     that     262619

```

The sentence-aligned corpus now looks like this:

```

> head -9 corpus/en-de-int-train.snt
1
3469 5 2049
4107 5 2 1399
1
10 3214 4 116 2007 2 9 5254 1151 985 6447 2049 21 44 141 14 2580 3
14 2213 1866 2 1399 5 2 29 46 3256 18 1969 4 2363 1239 1111 3
1
7179
306

```

A sentence pair now consists of three lines: First the frequency of this sentence. In our training process this is always 1. This number can be used for weighting different parts of the training corpus differently. The two lines below contain word ids of the foreign and the English sentence. In the sequence 4107 5 2 1399 we can recognize of (5) and the (2).

GIZA++ also requires words to be placed into word classes. This is done automatically by calling the `mkcls` program. Word classes are only used for the IBM reordering model in GIZA++. A peek into the foreign word class file:

```
> head corpus/de.vcb.classes
!      14
"      14
#      30
%      31
&      10
'      14
(      10
)      14
+      31
,      11
```

*Subsection last modified on July 14, 2006, at 02:07 AM*

## 5.5 Training Step 2: Run GIZA++

GIZA++ is a freely available implementation of the IBM models. We need it as a initial step to establish word alignments. Our word alignments are taken from the intersection of bidirectional runs of GIZA++ plus some additional alignment points from the union of the two runs.

Running GIZA++ is the most time consuming step in the training process. It also requires a lot of memory (1-2 GB RAM is common for large parallel corpora).

GIZA++ learns the translation tables of IBM Model 4, but we are only interested in the word alignment file:

```
> zcat giza.de-en/de-en.A3.final.gz | head -9
# Sentence pair (1) source length 4 target length 3 alignment score : 0.00643931
wiederaufnahme der sitzungsperiode
NULL ({} ) resumption ({} 1 ) of ({} ) the ({} 2 ) session ({} 3 )
# Sentence pair (2) source length 17 target length 18 alignment score : 1.74092e-26
ich erkläre die am donnerstag , den 28. märz 1996 unterbrochene sitzungsperiode
des europaischen parlaments fuer wiederaufgenommen .
NULL ({} 7 ) i ({} 1 ) declare ({} 2 ) resumed ({} ) the ({} 3 ) session ({} 12 )
of ({} 13 ) the ({} ) european ({} 14 ) parliament ({} 15 )
adjourned ({} 11 16 17 ) on ({} ) thursday ({} 4 5 ) , ({} 6 ) 28 ({} 8 )
march ({} 9 ) 1996 ({} 10 ) . ({} 18 )
# Sentence pair (3) source length 1 target length 1 alignment score : 0.012128
begrueßung
NULL ({} ) welcome ({} 1 )
```

In this file, after some statistical information and the foreign sentence, the English sentence is listed word by word, with references to aligned foreign words: The first word `resumption` (`{ 1 }`) is aligned to the first German word `wiederaufnahme`. The second word of (`{ }`) is unaligned. And so on.

Note that each English word may be aligned to multiple foreign words, but each foreign word may only be aligned to at most one English word. This one-to-many restriction is reversed in the inverse GIZA++ training run:

```
> zcat giza.en-de/en-de.A3.final.gz | head -9
# Sentence pair (1) source length 3 target length 4 alignment score : 0.000985823
resumption of the session
NULL ({ }) wiederaufnahme ({ 1 2 }) der ({ 3 }) sitzungsperiode ({ 4 })
# Sentence pair (2) source length 18 target length 17 alignment score : 6.04498e-19
i declare resumed the session of the european parliament adjourned on thursday ,
28 march 1996 .
NULL ({ }) ich ({ 1 }) erkläre ({ 2 10 }) die ({ 4 }) am ({ 11 })
donnerstag ({ 12 }) , ({ 13 }) den ({ }) 28. ({ 14 }) maerz ({ 15 })
1996 ({ 16 }) unterbrochene ({ 3 }) sitzungsperiode ({ 5 }) des ({ 6 7 })
europaeischen ({ 8 }) parlaments ({ 9 }) fuer ({ }) wiederaufgenommen ({ })
. ({ 17 })
# Sentence pair (3) source length 1 target length 1 alignment score : 0.706027
welcome
NULL ({ }) begruessung ({ 1 })
```

### 5.5.1 Training on really large corpora

GIZA++ is not only the slowest part of the training, it is also the most critical in terms of memory requirements. To better be able to deal with the memory requirements, it is possible to train a preparation step on parts of the data that involves an additional program called `snt2cooc`.

For practical purposes, all you need to know is that the switch `--parts n` may allow training on large corpora that would not be feasible otherwise (a typical value for `n` is 3).

This is currently not a problem for Europarl training, but is necessary for large Arabic and Chinese training runs.

### 5.5.2 Training in parallel

Using the `--parallel` option will fork the script and run the two directions of GIZA++ as independent processes. This is the best choice on a multi-processor machine.

If you have only single-processor machines and still wish to run the two GIZA++ processes in parallel, use the following (rather obsolete) trick. Support for this is not fully user friendly, some manual involvement is essential.

- First you start training the usual way with the additional switches `--last-step 2 --direction 1`, which runs the data preparation and one direction of GIZA++ training
- When the GIZA++ step started, start a second training run with the switches `--first-step 2 --direction 2`. This runs the second GIZA++ run in parallel, and then continues the rest of the model training. (Beware of race conditions! The second GIZA++ run might finish earlier than the first one to training step 3 might start too early!)

*Subsection last modified on July 28, 2013, at 09:47 AM*

## 5.6 Training Step 3: Align Words

To establish word alignments based on the two GIZA++ alignments, a number of heuristics may be applied. The default heuristic `grow-diag-final` starts with the intersection of the two alignments and then adds additional alignment points.

Other possible alignment methods:

- `intersection`
- `grow` (only add block-neighboring points)
- `grow-diag` (without final step)
- `union`
- `srctotgt` (only consider word-to-word alignments from the source-target GIZA++ alignment file)
- `tgttosrc` (only consider word-to-word alignments from the target-source GIZA++ alignment file)

Alternative alignment methods can be specified with the switch `--alignment`.

Here, the pseudo code for the default heuristic:

```
GROW-DIAG-FINAL(e2f, f2e):
neighboring = ((-1,0), (0,-1), (1,0), (0,1), (-1,-1), (-1,1), (1,-1), (1,1))
alignment = intersect(e2f, f2e);
GROW-DIAG(); FINAL(e2f); FINAL(f2e);

GROW-DIAG():
iterate until no new points added
for english word e = 0 ... en
for foreign word f = 0 ... fn
if ( e aligned with f )
for each neighboring point ( e-new, f-new ):
if ( ( e-new not aligned or f-new not aligned ) and
( e-new, f-new ) in union( e2f, f2e ) )
add alignment point ( e-new, f-new )
FINAL(a):
for english word e-new = 0 ... en
for foreign word f-new = 0 ... fn
```

```

if ( ( e-new not aligned or f-new not aligned ) and
( e-new, f-new ) in alignment a )
add alignment point ( e-new, f-new )

```

To illustrate this heuristic, see the example in the Figure below with the intersection of the two alignments for the second sentence in the corpus above

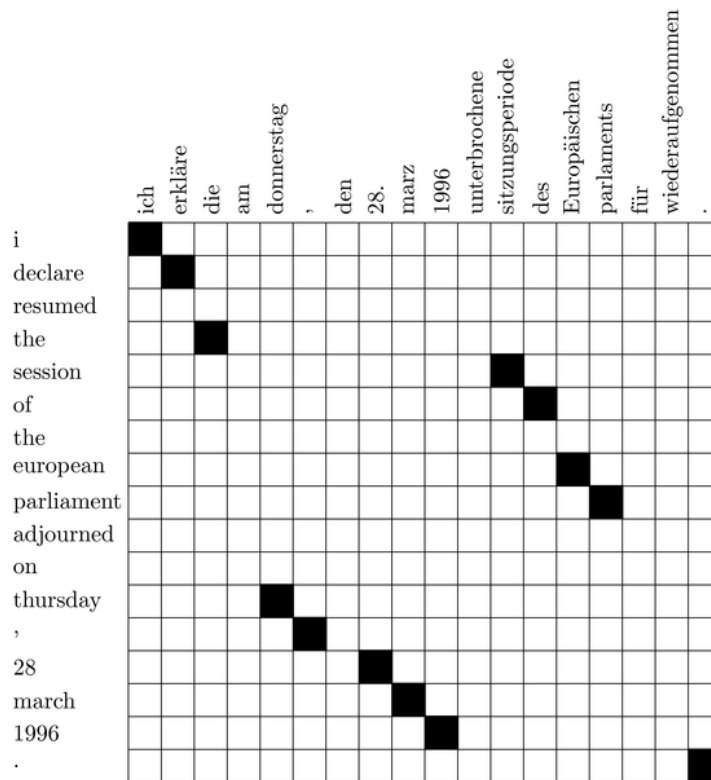

and then add some additional alignment points that lie in the union of the two alignments



	ich	erkläre	die	am	donnerstag	,	den	28.	marz	1996	unterbrochene	sitzungsperiode	des	Europäischen	parlaments	für	wiederaufgenommen	.	
i	■																		
declare		■																	
resumed											■								
the			■																
session												■							
of													■						
the														■					
european															■				
parliament																■			
adjourned																	■	■	
on																		■	■
thursday				■	■														
,						■													
28							■												
march								■											
1996									■										
.																			■

This alignment has a blatant error: the alignment of the two verbs is mixed up. `resumed` is aligned to `unterbrochene`, and `adjourned` is aligned to `wiederaufgenommen`, but it should be the other way around.

To conclude this section, a quick look into the files generated by the word alignment process:

```

==> model/aligned.de <==
wiederaufnahme der sitzungsperiode
ich erkläre die am donnerstag , den 28. märz 1996 unterbrochene sitzungsperiode
des europaeischen parlaments fuer wiederaufgenommen .
begruessung

==> model/aligned.en <==
resumption of the session
i declare resumed the session of the european parliament adjourned on
thursday , 28 march 1996 .
welcome

==> model/aligned.grow-diag-final <==
0-0 0-1 1-2 2-3
0-0 1-1 2-3 3-10 3-11 4-11 5-12 7-13 8-14 9-15 10-2 11-4 12-5 12-6 13-7
14-8 15-9 16-9 17-16
0-0

```

The third file contains alignment information, one alignment point at a time, in form of the position of the foreign and English word.

*Subsection last modified on April 26, 2012, at 06:17 PM*

## 5.7 Training Step 4: Get Lexical Translation Table

Given this alignment, it is quite straight-forward to estimate a maximum likelihood lexical translation table. We estimate the  $w(e|f)$  as well as the inverse  $w(f|e)$  word translation table. Here are the top translations for `europa` into English:

```
> grep ' europa ' model/lex.f2n | sort -nrk 3 | head
europe europa 0.8874152
european europa 0.0542998
union europa 0.0047325
it europa 0.0039230
we europa 0.0021795
eu europa 0.0019304
europeans europa 0.0016190
euro-mediterranean europa 0.0011209
europa europa 0.0010586
continent europa 0.0008718
```

*Subsection last modified on July 14, 2006, at 02:15 AM*

## 5.8 Training Step 5: Extract Phrases

In the phrase extraction step, all phrases are dumped into one big file. Here is the top of that file:

```
> head model/extract
wiederaufnahme ||| resumption ||| 0-0
wiederaufnahme der ||| resumption of the ||| 0-0 1-1 1-2
wiederaufnahme der sitzungsperiode ||| resumption of the session ||| 0-0 1-1 1-2 2-3
der ||| of the ||| 0-0 0-1
der sitzungsperiode ||| of the session ||| 0-0 0-1 1-2
sitzungsperiode ||| session ||| 0-0
ich ||| i ||| 0-0
ich erkläre ||| i declare ||| 0-0 1-1
erkläre ||| declare ||| 0-0
sitzungsperiode ||| session ||| 0-0
```

The content of this file is for each line: foreign phrase, English phrase, and alignment points. Alignment points are pairs (foreign,english). Also, an inverted alignment file `extract.inv` is generated, and if the lexicalized reordering model is trained (default), a reordering file `extract.o`.

*Subsection last modified on July 14, 2006, at 02:15 AM*

## 5.9 Training Step 6: Score Phrases

Subsequently, a translation table is created from the stored phrase translation pairs. The two steps are separated, because for larger translation models, the phrase translation table does not fit into memory. Fortunately, we never have to store the phrase translation table into memory — we can construct it on disk.

To estimate the phrase translation probability  $\phi(e|f)$  we proceed as follows: First, the `extract` file is sorted. This ensures that all English phrase translations for an foreign phrase are next to each other in the file. Thus, we can process the file, one foreign phrase at a time, collect counts and compute  $\phi(e|f)$  for that foreign phrase  $f$ . To estimate  $\phi(f|e)$ , the inverted file is sorted, and then  $\phi(f|e)$  is estimated for an English phrase at a time.

Next to phrase translation probability distributions  $\phi(f|e)$  and  $\phi(e|f)$ , additional phrase translation scoring functions can be computed, e.g. lexical weighting, word penalty, phrase penalty, etc. Currently, lexical weighting is added for both directions and a fifth score is the phrase penalty.

```
> grep '| in europe |' model/phrase-table | sort -nrk 7 -t\| | head
in europa ||| in europe ||| 0.829007 0.207955 0.801493 0.492402
europas ||| in europe ||| 0.0251019 0.066211 0.0342506 0.0079563
in der europaeischen union ||| in europe ||| 0.018451 0.00100126 0.0319584 0.0196869
in europa , ||| in europe ||| 0.011371 0.207955 0.207843 0.492402
europaeischen ||| in europe ||| 0.00686548 0.0754338 0.000863791 0.046128
im europaeischen ||| in europe ||| 0.00579275 0.00914601 0.0241287 0.0162482
fuer europa ||| in europe ||| 0.00493456 0.0132369 0.0372168 0.0511473
in europa zu ||| in europe ||| 0.00429092 0.207955 0.714286 0.492402
an europa ||| in europe ||| 0.00386183 0.0114416 0.352941 0.118441
der europaeischen ||| in europe ||| 0.00343274 0.00141532 0.00099583 0.000512159
```

Currently, four different phrase translation scores are computed:

1. inverse phrase translation probability  $\phi(f|e)$
2. inverse lexical weighting  $lex(f|e)$
3. direct phrase translation probability  $\phi(e|f)$
4. direct lexical weighting  $lex(e|f)$

Previously, there was another score:

1. phrase penalty (always  $exp(1) = 2.718$ )

This has now been superceded by it's own feature function, `PhrasePenalty`.

### Using a subset of scores

You may not want to use all the scores in your translation table. The following options allow you to remove some of the scores:

- `NoLex` -- do not use lexical scores (removes score 2 and 4)
- `OnlyDirect` -- do not use the inverse scores (removes score 1 and 2)

These settings have to be specified with the setting `-score-options` when calling the script `train-model.perl`, for instance:

```
train-model.perl [... other settings ...] -score-options '--NoLex'
```

*NB* - the `consolidate` program (that runs after score) also has a few arguments. For example, it has

- `PhraseCount` -- add the old phrase count feature (score 5)

However, this can't be set with by the `train-model.perl` script.

### Good Turing discounting

Singleton phrase pairs tend to have overestimated phrase translation probabilities. Consider the extreme case of a source phrase that occurs only once in the corpus and has only one translation. The corresponding phrase translation probability  $\phi(e|f)$  would be 1.

To obtain better phrase translation probabilities, the observed counts may be reduced by *expected* counts which takes unobserved events into account. Borrowing a method from language model estimation, Good Turing discounting can be used to reduce the actual counts (such as 1 in the example above) and reduce it to a more realistic number (maybe 0.3). The value of the adjusted count is determined by an analysis of the number of singleton, twice-occurring, thrice-occurring, etc. phrase pairs that were extracted.

To use Good Turing discounting of the phrase translation probabilities, you have to specify `--GoodTuring` as one of the `-score-options`, as in the section above. The adjusted counts are reported to `STDERR`.

### Word-to-word alignment

An enhanced version of the scoring script outputs the word-to-word alignments between  $f$  and  $e$  as they are in the files (`extract` and `extract.inv`) generated in the previous training step "Extract Phrases" (Section 5.8).

The alignments information are reported in the fourth fields. The format is identical to the alignment output obtained when the GIZA++ output has been symmetrized prior to phrase extraction.

```
> grep '| in europe |' model/phrase-table | sort -nrk 7 -t\| | head
in europa ||| in europe ||| 0.829007 0.207955 ||| 0-0 1-1 ||| ...
europas ||| in europe ||| ... ||| 0-0 0-1 ||| ...
in der europaeischen union ||| in europe ||| ... ||| 0-0 2-1 3-1 |||
in europa , ||| in europe ||| ... ||| 0-0 1-1 ||| ...
europaeischen ||| in europe ||| ... ||| 0-1 ||| ...
im europaeischen ||| in europe ||| ... ||| 0-0 1-1 |||
```

For instance:

```
in der europaeischen union ||| in europe ||| 0-0 2-1 3-1 ||| ...
```

means

```
German      -> English
in          -> in
der         ->
europaeischen -> europe
union       -> europe
```

The word-to-word alignments come from one word alignment (see training step "Align words" (Section 5.6)).

The alignment information is also used in SCFG-rules for the chart-decoder to link non-terminals together in the source and target side. In this instance, the alignment information is not an option, but a necessity. For example, the following Moses SCFG rule

```
[X][X] miss [X][X] [X] ||| [X][X] [X][X] manques [X] ||| ... ||| 0-1 2-0 ||| ...
```

is formatted as this in the Hiero format:

```
[X] ||| [X,1] miss [X,2] ||| [X,2] [X,1] manques ||| ....
```

ie. this rule reorders the 1st and 3rd non-terminals in the source.

Therefore, the same alignment field can be used for word-alignment and non-terminal co-indexes. However, I'm (Hieu) sure if anyone has implemented this in the chart decoder yet

### Columns in the phrase-table

There is a maximum of 7 columns in the phrase table:

1. Source phrase
2. Target phrase
3. Scores
4. Alignment
5. Counts
6. Sparse feature scores
7. Key-value properties

*Subsection last modified on December 02, 2014, at 02:30 PM*

## 5.10 Training Step 7: Build reordering model

By default, only a distance-based reordering model is included in final configuration. This model gives a cost linear to the reordering distance. For instance, skipping over two words costs twice as much as skipping over one word.

However, additional conditional reordering models, so called lexicalized reordering models, may be build. There are three types of lexicalized reordering models in Moses that are based on Koehn et al. (2005)<sup>1</sup> and Galley and Manning (2008)<sup>2</sup>. The Koehn at al. model determines the orientation of two phrases based on word alignments at training time, and based on phrase alignments at decoding time. The other two models are based on Galley and Manning. The phrase-based model uses phrases both at training and decoding time, and the hierarchical model allows combinations of several phrases for determining the orientation.

The lexicalized reordering models are specified by a configuration string, containing five parts, that account for different aspects:

- **Modeltype** - the type of model used (see above)
  - **wbe** - word-based extraction (but phrase-based at decoding). This is the original model in Moses. **DEFAULT**
  - **phrase** - phrase-based model
  - **hier** - hierarchical model
- **Orientation** - Which classes of orientations that are used in the model
  - **mslr** - Considers four different orientations: **monotone**, **swap**, **discontinuous-left**, **discontinuous-right**
  - **msd** - Considers three different orientations: **monotone**, **swap**, **discontinuous** (the two discontinuous classes of the mslr model are merged into one class)
  - **monotonicity** - Considers two different orientations: **monotone** or **non-monotone** (**swap** and **discontinuous** of the msd model are merged into the **non-monotone** class)

<sup>1</sup><http://homepages.inf.ed.ac.uk/pkoehn/publications/iwslt05-report.pdf>

<sup>2</sup><http://www.aclweb.org/anthology/D/D08/D08-1089.pdf>

- leftright - Considers two different orientations: left or right (the four classes in the mslr model are merged into two classes, swap and discontinuous-left into left and monotone and discontinuous-right into right)
- **Directionality** - Determines if the orientation should be modeled based on the previous or next phrase, or both.
  - backward - determine orientation with respect to previous phrase **DEFAULT**
  - forward - determine orientation with respect to following phrase
  - bidirectional - use both backward and forward models
- **language** - decides which language to base the model on
  - fe - conditioned on both the source and target languages
  - f - conditioned on the source language only
- **collapsing** - determines how to treat the scores
  - allff - treat the scores as individual feature functions **DEFAULT**
  - collapseff - collapse all scores in one direction into one feature function

any possible configuration of these five factors is allowed. It is always necessary to specify orientation and language. The other three factors use the default values indicated above if they are not specified. Some examples of possible models are:

- msd-bidirectional-fe (this model is commonly used, for instance it is the model used in the WMT baselines<sup>3</sup>)
- wbe-msd-bidirectional-fe-allff same model as above
- mslr-f
- wbe-backward-mslr-f-allff same model as above
- phrase-msd-bidirectional-fe
- hier-mslr-bidirectional-fe
- hier-leftright-forward-f-collapseff

and of course distance.

Which reordering model(s) that are used (and built during the training process, if necessary) can be set with the switch `-reordering`, e.g.:

```
-reordering distance
-reordering msd-bidirectional-fe
-reordering msd-bidirectional-fe,hier-mslr-bidirectional-fe
-reordering distance,msd-bidirectional-fe,hier-mslr-bidirectional-fe
```

Note that the distance model is always included, so there is no need to specify it.

The number of features that are created with a lexical reordering model depends on the type of the model. If the flag `allff` is used, a `msd` model has three features, one each for the probability that the phrase is translated monotone, swapped, or discontinuous, a `mslr` model has four features and a `monotonicity` or `leftright` model has two features. If a `bidirectional` model is used, then the number of features doubles - one for each direction. If `collapseff` are used there is one feature for each direction, regardless of which orientation types that are used.

There are also a number of other flags that can be given to `train-model.perl` that concerns the reordering models:

<sup>3</sup><http://www.statmt.org/wmt11/baseline.html>

- `--reordering-smooth` - specifies the smoothing constant to be used for training lexicalized reordering models. If the letter `u` follows the constant, smoothing is based on actual counts. (default 0.5)
- `--max-lexical-reordering` - if this flag is used, the extract file will contain information for the mslr orientations for all three model types, `wbe`, `phrase` and `hier`. Otherwise the extract file will contain the minimum information that is needed based on which reordering model config strings that are given.

*Subsection last modified on July 28, 2013, at 04:55 AM*

## 5.11 Training Step 8: Build generation model

The generation model is build from the target side of the parallel corpus.

By default, forward and backward probabilities are computed. If you use the switch `--generation-type single` only the probabilities in the direction of the step are computed.

*Subsection last modified on May 05, 2010, at 07:00 PM*

## 5.12 Training Step 9: Create Configuration File

As a final step, a configuration file for the decoder is generated with all the correct paths for the generated model and a number of default parameter settings.

This file is called `model/moses.ini`

You will also need to train a language model. This is described in the decoder manual.

Note that the configuration file set `--by default--` the usage of SRILM as a LM toolkit. If you prefer to use another LM toolkit, change the configuration file as described here<sup>4</sup>

*Subsection last modified on September 26, 2011, at 10:16 AM*

## 5.13 Building a Language Model

### 5.13.1 Language Models in Moses

The language model should be trained on a corpus that is suitable to the domain. If the translation model is trained on a parallel corpus, then the language model should be trained on the output side of that corpus, although using additional training data is often beneficial.

Our decoder works with the following language models:

- the SRI language modeling toolkit<sup>5</sup>, which is freely available.

<sup>4</sup><http://www.statmt.org/moses/?n=FactoredTraining.BuildingLanguageModel#ntoc1>

<sup>5</sup><http://www.speech.sri.com/projects/srilm/>



- the IRST language modeling toolkit<sup>6</sup>, which is freely available and open source.
- the RandLM language modeling toolkit<sup>7</sup>, which is freely available and open source.
- the KenLM language modeling toolkit<sup>8</sup>, which is included in Moses by default.
- the DALM language modeling toolkit<sup>9</sup>, which is freely available and open source.
- the OxLM language modeling toolkit<sup>10</sup>, which is freely available and open source.
- the NPLM language modeling toolkit<sup>11</sup>, which is freely available and open source.

To use these language models, they have to be compiled with the proper option:

- `--with-srilm=<root dir of the SRILM toolkit>`
- `--with-irstlm=<root dir of the IRSTLM toolkit>`
- `--with-randlm=<root dir of the RandLM toolkit>`
- `--with-dalm=<root dir of the DALM toolkit>`
- `--with-oxlm=<root dir of the OxLM toolkit>`
- `--with-nplm=<root dir of the NPLM toolkit>`

KenLM is compiled by default. In the Moses configuration file, the type (SRI/IRST/RandLM/KenLM/DALM) of the LM is specified by the feature function class, eg.

```
[feature]
SRILM path=filename.srilm order=3 .....
```

or

```
IRSTLM path=filename.irstlm ...
```

or

```
RANDLM path=filename.irstlm ...
```

or

```
KENLM path=filename.arpa ...
```

<sup>6</sup><http://sourceforge.net/projects/irstlm/>

<sup>7</sup><http://sourceforge.net/projects/randlm/>

<sup>8</sup><http://kheafield.com/code/kenlm/>

<sup>9</sup><https://github.com/jnory/DALM>

<sup>10</sup><https://github.com/pauldb89/oxlm>

<sup>11</sup><https://github.com/moses-smt/nplm>

or

```
DALM path=filename.dalm ...
```

The toolkits all come with programs that create a language model file, as required by our decoder. ARPA files are generally exchangeable, so you can estimate with one toolkit and query with a different one.

### 5.13.2 Enabling the LM OOV Feature

Moses offers the option to add an additional LM feature that counts the number of occurrences of unknown words in a hypothesis. Most language model implementations in Moses support this feature. To enable it, add `oov-feature=1` to the language model line in `moses.ini`:

```
...LM path=... oov-feature=1 ...
```

### 5.13.3 Building a LM with the SRILM Toolkit

A language model can be created by calling:

```
ngram-count -text CORPUS_FILE -lm SRILM_FILE
```

The command works also on compressed (gz) input and output. There are a variety of switches that can be used, we recommend `-interpolate` `-kndiscount`.

### 5.13.4 On the IRSTLM Toolkit

Moses can also use language models created with the IRSTLM toolkit (see Federico & Cettolo, (ACL WS-SMT, 2007)<sup>12</sup>). The commands described in the following are supplied with the IRSTLM toolkit that has to be downloaded<sup>13</sup> and compiled separately.

IRSTLM toolkit handles LM formats which permit to reduce both storage and decoding memory requirements, and to save time in LM loading. In particular, it provides tools for:

- building (huge) LMs (Section 5.13.4)
- quantizing LMs (Section 5.13.4)
- compiling LMs (possibly quantized) into a binary format (Section 5.13.4)
- accessing binary LMs through the memory mapping mechanism (Section 5.13.4)
- query class and chunk LMs (Section 5.13.4)

<sup>12</sup><http://www.aclweb.org/anthology-new/W/W07/W07-0712.pdf>

<sup>13</sup><http://sourceforge.net/projects/irstlm>

## Compiling IRSTLM

Compiling IRSTLM requires:

1. automake 1.9 or higher
2. autoconf 2.59 or higher
3. libtool 2.2.6 or higher

Download IRSTLM as follows:

```
wget http://sourceforge.net/projects/irstlm/files/irstlm/irstlm-5.80/irstlm-5.80.06.tgz/download
```

Un-archive the file `irstlm-5.80.06.tgz`

```
tar zxvf irstlm-5.80.06.tgz
```

To install IRSTLM, follow the instruction reported in the `irstlm-5.80.06/README`.

The binaries and libraries will be installed in the installation directory, in `bin/` and `lib/`, respectively.

## Building Huge Language Models

Training a language model from huge amounts of data can be definitively memory and time expensive. The IRSTLM toolkit features algorithms and data structures suitable to estimate, store, and access very large LMs. IRSTLM is open source and can be downloaded from here<sup>14</sup>.

Typically, LM estimation starts with the collection of n-grams and their frequency counters. Then, smoothing parameters are estimated for each n-gram level; infrequent n-grams are possibly pruned and, finally, a LM file is created containing n-grams with probabilities and back-off weights. This procedure can be very demanding in terms of memory and time if applied to huge corpora. IRSTLM provides a simple way to split LM training into smaller and independent steps, which can be distributed among independent processes.

The procedure relies on a training script that makes little use of computer memory and implements the Witten-Bell smoothing method. (An approximation of the modified Kneser-Ney smoothing method is also available.) First, create a special directory `stat` under your working directory, where the script will save lots of temporary files; then, simply run the script `build-lm.sh` as in the example:

---

<sup>14</sup><http://sourceforge.net/projects/irstlm>

```
build-lm.sh -i "gunzip -c corpus.gz" -n 3 -o train.irstlm.gz -k 10
```

The script builds a 3-gram LM (option `-n`) from the specified input command (`-i`), by splitting the training procedure into 10 steps (`-k`). The LM will be saved in the output (`-o`) file `train.irstlm.gz` with an intermediate ARPA format. This format can be properly managed through the `compile-lm` command in order to produce a compiled version or a standard ARPA version of the LM.

For a detailed description of the procedure and other commands available under IRSTLM please refer to the user manual supplied with the package.

### Binary Language Models

You can convert your language model file (created either with the SRILM `ngram-count` command or with the IRSTLM toolkit) into a compact binary format with the command:

```
compile-lm language-model.srlm language-model.blm
```

Moses compiled with the IRSTLM toolkit is able to properly handle that binary format; the setting of `moses.ini` for that file is:

```
IRSTLM order=3 factor=0 path=language-model.blm
```

The binary format allows LMs to be efficiently stored and loaded. The implementation privileges memory saving rather than access time.

### Quantized Language Models

Before compiling the language model, you can quantize (see Federico & Bertoldi, (ACL WS-SMT, 2006)<sup>15</sup>) its probabilities and back-off weights with the command:

```
quantize-lm language-model.srlm language-model.qsrlm
```

Hence, the binary format for this file is generated by the command:

<sup>15</sup><http://www.aclweb.org/anthology/W/W06/W06-3113>

```
compile-lm language-model.qsrilm language-model.qblm
```

The resulting language model requires less memory because all its probabilities and back-off weights are now stored in 1 byte instead of 4. No special setting of the configuration file is required: Moses compiled with the IRSTLM toolkit is able to read the necessary information from the header of the file.

### Memory Mapping

It is possible to avoid the loading of the LM into the central memory by exploiting the memory mapping mechanism. Memory mapping permits the decoding process to directly access the (binary) LM file stored on the hard disk.

*Warning:* In case of parallel decoding in a cluster of computers, each process will access the same file. The possible large number of reading requests could overload the driver of the hard disk which the LM is stored on, and/or the network. One possible solution to such a problem is to store a copy of the LM on the local disk of each processing node, for example under the */tmp/* directory.

In order to activate the access through the memory mapping, simply add the suffix *.mm* to the name of the LM file (which must be stored in the binary format) and update the Moses configuration file accordingly.

As an example, let us suppose that the 3gram LM has been built and stored in binary format in the file

```
language-model.blm
```

Rename it for adding the *.mm* suffix:

```
mv language-model.blm language-model.blm.mm
```

or create a properly named symbolic link to the original file:

```
ln -s language-model.blm language-model.blm.mm
```

Now, the activation of the memory mapping mechanism is obtained simply by updating the Moses configuration file as follows:

```
IRSTLM order=3 factor=0 path=language-model.blm.mm
```

### Class Language Models and more

Typically, LMs employed by Moses provide the probability of n-grams of single factors. In addition to the standard way, the IRSTLM toolkit allows Moses to query the LMs in other different ways. In the following description, it is assumed that the target side of training texts contains words which are concatenation of  $N \geq 1$  fields separated by the character #. Similarly to factored models, where the word is not anymore a simple token but a vector of factors that can represent different levels of annotation, here the word can be the concatenation of different tags for the surface form of a word, e.g.:

```
word#lemma#part-of-speech#word-class
```

Specific LMs for each tag can be queried by Moses simply by adding a fourth parameter in the line of the configuration file devoted to the specification of the LM. The additional parameter is a file containing (at least) the following header:

```
FIELD <int>
```

Possibly, it can also include a one-to-one map which is applied to each component of n-grams before the LM query:

```
w1 class(w1)
w2 class(w2)
...
wM class(wM)
```

The value of <int> determines the processing applied to the n-gram components, which are supposed to be strings like `field0#field1#...#fieldN`:

- -1: the strings are used as they are; if the map is given, it is applied to the whole string before the LM query
- 0-9: the field number <int> is selected; if the map is given, it is applied to the selected field

- 00-99: the two fields corresponding to the two digits are selected and concatenated together using the character `_` as separator. For example, if `<int>=21`, the LM is queried with n-grams of strings `field2_field1`. If the map is given, it is applied to the field corresponding to the first digit.

The last case is useful for lexicalization of LMs: if the fields `n. 2` and `1` correspond to the POS and lemma of the actual word respectively, the LM is queried with n-grams of `POS_lemma`.

**Chunk Language Models** A particular processing is performed whenever fields are supposed to correspond to *microtags*, i.e. the per-word projections of chunk labels. The processing aims at collapsing the sequence of microtags defining a chunk to the label of that chunk. The chunk LM is then queried with n-grams of chunk labels, in an asynchronous manner with respect to the sequence of words, as in general chunks consist of more words.

The collapsing operation is automatically activated if the sequence of microtags is:

```
(TAG TAG+ TAG+ ... TAG+ TAG)
```

or

```
TAG( TAG+ TAG+ ... TAG+ TAG)
```

Both those sequences are collapsed into a single chunk label (let us say `CHNK`) as long as `(TAG / TAG(, TAG+ and TAG)` are all mapped into the same label `CHNK`. The map into different labels or a different use/position of characters (`,` `+` and `)` in the lexicon of tags prevent the collapsing operation.

Currently (Aug 2008), lexicalized chunk LMs are still under investigation and only non-lexicalized chunk LMs are properly handled; then, the range of admitted `<int>` values for this kind of LMs is `-1...9`, with the above described meaning.

### 5.13.5 RandLM

If you really want to build the largest LMs possible (for example, a 5-gram trained on one hundred billion words then you should look at the RandLM. This takes a very different approach to either the SRILM or the IRSTLM. It represents LMs using a randomized data structure (technically, variants of Bloom filters). This can result in LMs that are ten times smaller than those created using the SRILM (and also smaller than IRSTLM), but at the cost of making decoding about four times slower. RandLM is multithreaded now, so the speed reduction should be less of a problem.

Technical details of randomized language modelling can be found in a ACL paper (see Talbot and Osborne, (ACL 2007)<sup>16</sup>)

<sup>16</sup><http://aclweb.org/anthology-new/P/P07/P07-1065.pdf>

## Installing RandLM

RandLM is available at Sourceforge<sup>17</sup>.

After extracting the tar ball, go to the directory `src` and type `make`.

For integrating RandLM into Moses, please see above.

## Building a randomized language model

The `buildlm` binary (in `randlm/bin`) preprocesses and builds randomized language models.

The toolkit provides three ways for building a randomized language models:

1. from a tokenised corpus (this is useful for files around 100 million words or less)
2. from a precomputed backoff language model in ARPA format (this is useful if you want to use a precomputed SRILM model)
3. from a set of precomputed ngram-count pairs (this is useful if you need to build LMs from billions of words. RandLM has supporting Hadoop scripts).

The former type of model will be referred to as a **CountRandLM** while the second will be referred to as a **BackoffRandLM**. Models built from precomputed ngram-count pairs are also of type "CountRandLM". CountRandLMs use either StupidBackoff or else Witten-Bell smoothing. BackoffRandLM models can use any smoothing scheme that the SRILM implements. Generally, CountRandLMs are smaller than BackoffRandLMs, but use less sophisticated smoothing. When using billions of words of training material there is less of a need for good smoothing and so CountRandLMs become appropriate.

The following parameters are important in all cases:

- `struct`: The randomized data structure used to represent the language model (currently only BloomMap and LogFreqBloomFilter).
- `order`: The order of the n-gram model e.g., 3 for a trigram model.
- `falsepos`: The false positive rate of the randomized data structure on an inverse log scale so `-falsepos 8` produces a false positive rate of  $1/2^8$ .
- `values`: The quantization range used by the model. For a CountRandLM quantisation is performed by taking a logarithm. The base of the logarithm is set as  $2^{\lceil 1/\text{values} \rceil}$ . For a BackoffRandLM a binning quantisation algorithm is used. The size of the codebook is set as  $2^{\lceil \text{values} \rceil}$ . A reasonable setting in both cases is `-values 8`.
- `input-path`: The location of data to be used to create the language model.
- `input-type`: The format of the input data. The following four formats are supported
  - for a CountRandLM:
    - \* `corpus` tokenised corpora one sentence per line;
    - \* `counts` n-gram counts file (one count and one n-gram per line);
  - Given a 'corpus' file the toolkit will create a 'counts' file which may be reused (see examples below).
  - for a BackoffRandLM:
    - \* `arpa` an ARPA backoff language model;
    - \* `backoff` language model file (two floats and one n-gram per line).

<sup>17</sup><http://sourceforge.net/projects/randlm/>



- Given an arpa file the toolkit will create a 'backoff' file which may be reused (see examples below).
- `output-prefix`: Prefix added to all output files during the construction of a randomized language model.

**Example 1: Building directly from corpora** The command

```
./builddlm -struct BloomMap -falsepos 8 -values 8 -output-prefix model -order 3 < corpus
```

would produce the following files:-

```
model.BloomMap      <- the randomized language model
model.counts.sorted <- n-gram counts file
model.stats         <- statistics file (counts of counts)
model.vcb          <- vocabulary file (not needed)
```

`model.BloomMap`: This randomized language model is ready to use on its own (see 'Querying a randomized language model' below).

`model.counts.sorted`: This is a file in the RandLM 'counts' format with one count followed by one n-gram per line. It can be specified as shown in Example 3 below to avoid recomputation when building multiple randomized language models from the same corpus.

`model.stats`: This statistics file contains counts of counts and can be specified via the optional parameter '`-statspath`' as shown in Example 3 to avoid recomputation when building multiple randomized language models from the same data.

**Example 2: Building from an ARPA file (from another toolkit)** The command

```
./builddlm -struct BloomMap -falsepos 8 -values 8 -output-prefix model -order 3 \
-input-path precomputed.bo -input-type arpa
```

(where `precomputed.bo` contains an ARPA-formatted backoff model) would produce the following files:

```
model.BloomMap      <- the randomized language model
model.backoff       <- RandLM backoff file
model.stats         <- statistics file (counts of counts)
model.vcb          <- vocabulary file (not needed)
```

`model.backoff` is a RandLM formatted copy of the ARPA model. It can be reused in the same manner as the `model.counts.sorted` file (see Example 3).

**Example 3: Building a second randomized language model from the same data** The command

```
./buildlm -struct BloomMap -falsepos 4 -values 8 -output-prefix model4 -order 3
-input-path model.counts.sorted -input-type counts -stats-path model.stats
```

would construct a new randomized language model (`model4.BloomMap`) from the same data as used in Example 1 but with a different error rate (here `-falsepos 4`). This usage avoids re-tokenizing the corpus and recomputing the statistics file.

### Building Randomised LMs from 100 Billion Words using Hadoop

At some point you will discover that you cannot build a LM using your data. RandLM natively uses a disk-based method for creating n-grams and counts, but this will be slow for large corpora. Instead you can create these ngram-count pairs using Hadoop (Map-Reduce). The RandLM release has Hadoop scripts which take raw text files and create ngram-counts. We have built randomised LMs this way using more than 110 billion tokens.

The procedure for using Hadoop is as follows:

- You first load raw and possibly tokenised text files onto the Hadoop Distributed File System (DFS). This will probably involve commands such as:

```
Hadoop dfs -put myFile data/
```

- You then create ngram-counts using Hadoop (here a 5-gram):

```
perl hadoop-lm-count.prl data data-counts 5 data-counting
```

- You then upload the counts to the Unix filesystem:

```
perl hadoopRead.prl data-counts | gzip - > /unix/path/to/counts.gz
```

- These counts can then be passed to RandLM:

```
./builddlm -estimator batch -smoothing WittenBell -order 5 \
-values 12 -struct LogFreqBloomFilter -tmp-dir /disk5/miles \
-output-prefix giga3.rlm -output-dir /disk5/miles -falsepos 12 \
-keep-tmp-files -sorted-by-ngram -input-type counts \
-input-path /disk5/miles/counts.gz
```

### Querying Randomised Language Models

Moses uses its own interface to the randLM, but it may be interesting to query the language model directly. The `querylm` binary (in `randlm/bin`) allows a randomized language model to be queried. Unless specified the scores provided by the tool will be conditional log probabilities (subject to randomisation errors).

The following parameters are available:-

- `randlm`: The path of the randomized language model built using the `builddlm` tool as described above.
- `test-path`: The location of test data to be scored by the model.
- `test-type`: The format of the test data: currently corpus and ngrams are supported. corpus will treat each line in the test file as a sentence and provide scores for all n-grams (adding `<s>` and `</s>`). ngrams will score each line once treating each as an independent n-gram.
- `get-counts`: Return the counts of n-grams rather than conditional log probabilities (only supported by `CountRandLM`).
- `checks`: Applies sequential checks to n-grams to avoid unnecessary false positives.

Example: The command

```
./querylm -randlm model.BloomMap -test-path testfile -test-type ngrams -order 3 > scores
```

would write out conditional log probabilities one for each line in the file `test-file`.

- Finally, you then tell `randLM` to use these pre-computed counts.

#### 5.13.6 KenLM

KenLM is a language model that is simultaneously fast and low memory. The probabilities returned are the same as SRI, up to floating point rounding. It is maintained by Ken Heafield, who provides additional information on his website<sup>18</sup>, such as benchmarks<sup>19</sup> comparing speed and memory use against the other language model implementations. KenLM is distributed with Moses and compiled by default. KenLM is fully thread-safe for use with multi-threaded Moses.

<sup>18</sup><http://kheafield.com/code/kenlm/>

<sup>19</sup><http://kheafield.com/code/kenlm/benchmark/>

## Estimation

The `lmplz` program estimates language models with Modified Kneser-Ney smoothing and no pruning. Pass the order (`-o`), an amount of memory to use for building (`-S`), and a location to place temporary files (`-T`). Note that `-S` is compatible with GNU sort so e.g. 1G = 1 gigabyte and 80% means 80% of physical RAM. It scales to much larger models than SRILM can handle and does not resort to approximation like IRSTLM does.

```
bin/lmplz -o 5 -S 80% -T /tmp <text >text.arpa
```

See the page on estimation<sup>20</sup> for more.

**Using the EMS** To use `lmplz` in EMS set the following three parameters to your needs and copy the fourth one as is.

```
# path to lmplz binary
lmplz = $moses-bin-dir/lmplz
# order of the language model
order = 3
# additional parameters to lmplz (check lmplz help message)
settings = "-T $working-dir/tmp -S 10G"
# this tells EMS to use lmplz and tells EMS where lmplz is located
lm-training = "$moses-script-dir/generic/trainlm-lmplz.perl -lmplz $lmplz"
```

## Querying

ARPA files can be read directly:

```
KENLM factor=<factor> order=<order> path=filename.arpa
```

but the binary format loads much faster and provides more flexibility. The `<order>` field is ignored. By contrast, SRI silently returns incorrect probabilities if you get it wrong (Kneser-Ney smoothed probabilities for lower-order n-grams are conditioned on backing off).

<sup>20</sup><http://kheafield.com/code/kenlm/estimation/>

**Binary file** Using the binary format significantly reduces loading time. It also exposes more configuration options. The `kenlm/build_binary` program converts ARPA files to binary files:

```
kenlm/build_binary filename.arpa filename.binary
```

This will build a binary file that can be used in place of the ARPA file. Note that, unlike IRST, the file extension does not matter; the binary format is recognized using magic bytes. You can also specify the data structure to use:

```
kenlm/build_binary trie filename.arpa filename.binary
```

where valid values are `probing`, `sorted`, and `trie`. The default is `probing`. Generally, I recommend using `probing` if you have the memory and `trie` if you do not. See benchmarks for details. To determine the amount of RAM each data structure will take, provide only the arpa file:

```
kenlm/build_binary filename.arpa
```

Bear in mind that this includes only language model size, not the phrase table or decoder state. Building the trie entails an on-disk sort. You can optimize this by setting the sorting memory with `-S` using the same options as GNU sort e.g. `100M`, `1G`, `80%`. Final model building will still use the amount of memory needed to store the model. The `-T` option lets you customize where to place temporary files (the default is based on the output file name).

```
kenlm/build_binary -T /tmp/trie -S 1G trie filename.arpa filename.binary
```

**Full or lazy loading** KenLM supports lazy loading via `mmap`. This allows you to further reduce memory usage, especially with `trie` which has good memory locality. This is specified by another arguments in the feature function for the KENLM feature function:

```
KENLM ... lazyken=<true/false>
```

I recommend fully loading if you have the RAM for it; it actually takes less time to load the full model and use it because the disk does not have to seek during decoding. Lazy loading works best with local disk and is not recommended for networked filesystems.

**Probing** Probing is the fastest and default data structure. Unigram lookups happen by array index. Bigrams and longer n-grams are hashed to 64-bit integers which have very low probability of collision, even with the birthday attack<sup>21</sup>. This 64-bit hash is the key to a probing hash table where values are probability and backoff.

A linear probing hash table is an array consisting of blanks (zeros) and entries with non-zero keys. Lookup proceeds by hashing the key modulo the array size, starting at this point in the array, and scanning forward until the entry or a blank is found. The ratio of array size to number of entries is controlled by the probing multiplier parameter  $p$ . This is a time-space tradeoff: space is linear in  $p$  and time is  $O(p/(p-1))$ . The value of  $p$  can be set at binary building time e.g.

```
kenlm/build_binary -p 1.2 probing filename.arpa filename.binary
```

sets a value of 1.2. The default value is 1.5 meaning that one third of the array is blanks.

**Trie** The trie data structure uses less memory than all other options (except RandLM with stupid backoff), has the best memory locality, and is still faster than any other toolkit. However, it does take longer to build. It works in much the same way as SRI and IRST's inverted option. Like probing, unigram lookup is an array index. Records in the trie have a word index, probability, backoff, and pointer. All of the records for n-grams of the same order are stored consecutively in memory. An n-gram's pointer is actually the index into the (n+1)-gram array where block of (n+1)-grams with one more word of history starts. The end of this block is found by reading the next entry's pointer. Records within the block are sorted by word index. Because the vocabulary ids are randomly permuted, a uniform key distribution applies. Interpolation search within each block finds the word index and its corresponding probability, backoff, and pointer. The trie is compacted by using the minimum number of bits to store each integer. Probability is always non-positive, so the sign bit is also removed.

Since the trie stores many vocabulary ids and uses the minimum number of bits to do so, vocabulary filtering is highly effective for reducing overall model size even if less n-grams of higher order are removed.

**Quantization** The trie supports quantization to any number of bits from 1 to 25. To quantize to 8 bits, use `-q 8`. If you want to separately control probability and backoff quantization, use `-q` for probability and `-b` for backoff.

**Array compression (also known as *Chop*)** The trie pointers comprise a sorted array. These can be compressed using a technique from Raj and Whittaker by chopping off bits and storing offsets instead. The `-a` option acts as an upper bound on the number of bits to chop; it will never chop more bits than minimizes memory use. Since this is a time-space tradeoff (time is linear in the number of bits chopped), you can set the upper bound number of bits to chop using `-a`. To minimize memory, use `-a 64`. To save time, specify a lower limit e.g. `-a 10`.

<sup>21</sup>[http://en.wikipedia.org/wiki/Birthday\\_attack](http://en.wikipedia.org/wiki/Birthday_attack)

**Vocabulary lookup** The original strings are kept at the end of the binary file and passed to Moses at load time to obtain or generate Moses IDs. This is why lazy binary loading still takes a few seconds. KenLM stores a vector mapping from Moses ID to KenLM ID. The cost of this vector and Moses-side vocabulary word storage are not included in the memory use reported by `build_binary`. However, benchmarks<sup>22</sup> report the entire cost of running Moses.

### 5.13.7 OxLM

Please consult the documentation at <https://github.com/pauldb89/oxlm>

### 5.13.8 NPLM

NPLM is a neural network language model toolkit (homepage)<sup>23</sup>. We currently recommend installing a fork<sup>24</sup> which allows pre-multiplication of the input embedding and training with a single hidden layer for faster decoding.

#### Training

[the steps below are automated in the script `mosesdecoder/scripts/training/train-neurallm.py`] first, prepare the training data by extracting the vocabulary and converting it into numberized n-grams:

```
prepareNeuralLM --train_text mydata.txt --ngram_size 5 \  
--vocab_size 100000 --write_words_file words \  
--train_file train.ngrams \  
--validation_size 500 --validation_file validation.ngrams
```

this generates the files `train.ngrams`, `validation.ngrams`, and `words`.

then, train the actual neural network. This step can take very long, and you may need to adjust the amount of training data or number of epochs accordingly.

```
trainNeuralNetwork --train_file train.ngrams \  
--validation_file validation.ngrams \  
--num_epochs 10 \  
--words_file words \  
--model_prefix model \  
--input_embedding_dimension 150 \  
--num_hidden 0 \  
--output_embedding_dimension 750
```

<sup>22</sup><http://kheafield.com/code/kenlm/benchmark/>

<sup>23</sup><http://nlg.isi.edu/software/nplm/>

<sup>24</sup><https://github.com/moses-smt/nplm>

This configuration roughly corresponds to the settings described in (Vaswani et al. 2013)<sup>25</sup>, except that '--num\_hidden 0' results in a model with a single hidden layer, which is recommended for decoder integration.

**future cost estimates (<null> word)** Vaswani et al. (2013)<sup>26</sup> recommend using special null words which are the weighted average of all input embeddings to pad lower-order estimates. To do this, add <null> to the vocabulary file 'words' (**before** training the network), and perform the following command after training:

```
mosesdecoder/scripts/training/bilingual-lm/averageNullEmbedding.py \
-p /path/to/nplm/python \
-i input_model.nnlm \
-o output_model.nnlm \
-t train.ngrams
```

## Querying

to use a NPLM model during decoding, define it as a feature function in the moses configuration file:

```
[feature]
NeuralLM factor=<factor> order=<order> path=filename
```

## Use in EMS

Minimally, add the following to the [LM] section of your EMS config:

```
[LM:neural]
nplm-dir = /path/to/nplm/install
raw-corpus = /path/to/training/corpus
nplm = yes
```

You can use the variables `epochs`, `order` and `nplm-settings` to configure NPLM.

<sup>25</sup><http://nlg.isi.edu/software/nplm/vaswani-emnlp13.pdf>

<sup>26</sup><http://nlg.isi.edu/software/nplm/vaswani-emnlp13.pdf>



### 5.13.9 Bilingual Neural LM

An implementation of Devlin et al. (2014)<sup>27</sup>, a neural network language model that uses a target-side history as well as source-side context, is implemented in Moses as BilingualLM. It uses NPLM (Section 5.13.7) as back-end (check its installation instructions).

#### Training

The BilingualLM requires aligned parallel text for training. It uses the same format conventions as the train-model script.

First, extract the numbered n-grams:

```
mosesdecoder/scripts/training/bilingual-lm/extract_training.py --working-dir <working_dir> \  
--corpus <corpus_file_prefix> \  
--source-language <L1> \  
--target-language <L2> \  
--align <aligned_file.grow-diag-final-and> \  
--prune-target-vocab 100000 \  
--prune-source-vocab 100000 \  
--target-context 5 \  
--source-context 4
```

this configuration is for a 5-gram language model with 9 source context words (the affiliated source word and a window of 4 words to its left and right) for a total n-gram-size of 14.

then, train a neural network model:

```
mosesdecoder/scripts/training/bilingual-lm/train_nplm.py \  
--working-dir <working_dir> \  
--corpus <corpus_file_prefix> \  
--nplm-home </path/to/nplm> \  
--ngram-size 14 \  
--hidden 0 \  
--output-embedding 750 \  
--threads <number_of_threads>
```

'--hidden 0' results in a neural network with a single hidden layer, which is recommended for fast SMT decoding.

lastly, average the <null> word embedding as per the instructions here (Section 5.13.8).

<sup>27</sup><http://acl2014.org/acl2014/P14-1/pdf/P14-1129.pdf>

## Querying

to use a bilingual NPLM model during decoding, define it as a feature function in the Moses configuration file:

```
[feature]
BilingualNPLM order=5 source_window=4 path=/path/to/model source_vocab=/path/to/vocab.source target_vocab=/path/to/vocab.target
```

the model, vocab.source and vocab.target file are all in the working directory used for training the bilingual LM.

## Use in EMS

Minimally, add the following to the [LM] section of your EMS config:

```
[LM:comb]
nplm-dir = /path/to/nplm/install
order = 5
source-window = 4
bilingual-lm = yes
```

You can use the variables `epochs` to set the training epochs, `bilingual-lm-settings` to pass settings to the extraction script, and `nplm-settings` to control NPLM training.

### 5.13.10 Bilingual N-gram LM (OSM)

The Operation Sequence Model as described in Durrani et al. (2011)<sup>28</sup> and Durrani et al. (2013)<sup>29</sup> is a bilingual language model that also integrates reordering information.

To enable the OSM model in phrase-based decoder, just put the following in the EMS config file:

```
operation-sequence-model = "yes"
operation-sequence-model-order = 5
operation-sequence-model-settings = ""
```

If the data has been augmented with additional factors, then use (for example)

<sup>28</sup><http://aclweb.org/anthology/P/P11/P11-1105.pdf>

<sup>29</sup><http://aclweb.org/anthology/P/P13/P13-2071.pdf>

```
operation-sequence-model-settings = "--factor 0-0+1-1"
```

"0-0" will learn OSM model over lexical forms and "1-1" will learn OSM model over second factor (POS/Morph/Cluster-id etc.). Learning operation sequences over generalized representations such as POS/Morph tags/word classes, enables the model to overcome data sparsity Durrani et al. (2014)<sup>30</sup>.

If you want to train OSM model manually:

### Training

```
/path-to-moses/scripts/OSM/OSM-Train.perl --corpus-f corpus.fr --corpus-e corpus.en --alignment
aligned.grow-diag-final-and --order 5 --out-dir /path-to-experiment/model/OSM --moses-src-
dir /path-to-moses/ --srilm-dir /path-to-srilm/bin/i686-m64 --factor 0-0
```

### Querying

Added to model/moses.ini

```
[feature]
```

```
...
```

```
OpSequenceModel name=OpSequenceModel0 num-features=5 path=/path-to-experiment/model/OSM/operat
```

```
... [weight]
```

```
...
```

```
OpSequenceModel0= 0.08 -0.02 0.02 -0.001 0.03
```

```
...
```

### Interpolated OSM Model

OSM model trained from the plain concatenation of in-domain data with large and diverse multi-domain data is sub-optimal. When other domains are sufficiently larger and/or different than the in-domain, the probability distribution can skew away from the target domain resulting in poor performance. The LM-like nature of the model provides motivation to apply methods such as perplexity optimization for model weighting. The idea is to train OSM model on each domain separately and interpolate them by optimizing perplexity on held-out tuning set. To know more read Durrani et al. (2015)<sup>31</sup>.

### Usage

Provide tuning files as additional parameter in the settings. For example:

<sup>30</sup><http://www.statmt.org/OSMOSES/factor-v2.pdf>

<sup>31</sup><http://alt.qcri.org/~ndurrani/pubs/joint-models-domain.pdf>

```
interpolated-operation-sequence-model = "yes"
operation-sequence-model-order = 5
operation-sequence-model-settings = "--factor 0-0 --tune /path-to-tune-folder/tune_file --srilm-dir /path-to-srilm/bin/i686-m64"
```

This method requires word-alignment for the source and reference tuning files to generate operation sequences. This can be done using force-decoding of tuning set or by aligning tuning sets along with the training. The folder should contain files as (for example (tune.de , tune.en , tune.align).

Interpolation script does not work with LMPLZ and will require SRILM installation.

### 5.13.11 Dependency Language Model (RDLM)

RDLM (Sennrich 2015)<sup>32</sup> is a language model for the string-to-tree decoder with a dependency grammar. It should work with any corpus with projective dependency annotation in ConLL format, converted into the Moses format with the script `mosesdecoder/scripts/training/wrappers/conll2moses`. It depends on NPLM (Section 5.13.7) for neural network training and querying.

#### Training

RDLM is trained on a corpus annotated with dependency syntax. The training scripts support the same format as used for training a string-to-tree translation model. An example EMS for string-to-dependency training with Moses is provided here<sup>33</sup>. To train RDLM on additional monolingual data, or test it on some held-out test/dev data, parse and process it in the same way that the parallel corpus has been processed. This includes tokenization, parsing, truecasing, compound splitting etc.

RDLM is split into two neural network models, which can be trained with `train_rdlm.py`. An example command for training follows:

```
mkdir working_dir_head
mkdir working_dir_label
mosesdecoder/scripts/training/rdlm/train_rdlm.py --nplm-home /path/to/nplm --working-dir working_dir_head \ \ --output-dir /path/to/output_directory --output-mo
mosesdecoder/scripts/training/rdlm/train_rdlm.py --nplm-home /path/to/nplm --working-dir working_dir_label \ \ --output-dir /path/to/output_directory --output-mo
```

for more options, run `train_rdlm.py --help`. Parameters you may want to adjust include the size of the vocabulary and the neural network layers, and the number of training epochs.

<sup>32</sup><https://tacl2013.cs.columbia.edu/ojs/index.php/tacl/article/view/510>

<sup>33</sup><https://github.com/rsennrich/wmt2014-scripts/tree/master/example>

## Decoding

To use RDLM during decoding, add the following line to your mooses.ini config:

```
[feature]
RDLM path_head_lm=/path/to/rdlm_head.model.nplm path_label_lm=/path/to/rdlm_label.model.nplm context_up=2 context_left=3

[weight]
RDLM 0.1 0.1
```

*Subsection last modified on December 01, 2015, at 04:18 PM*

## 5.14 Tuning

### 5.14.1 Overview

During decoding, Moses scores translation hypotheses using a linear model. In the traditional approach, the features of the model are the probabilities from the language models, phrase/rule tables, and reordering models, plus word, phrase and rule counts. Recent versions of Moses support the augmentation of these **core features** with **sparse features** (Section 7.7), which may be much more numerous.

**Tuning** refers to the process of finding the optimal weights for this linear model, where optimal weights are those which maximise translation performance on a small set of parallel sentences (the **tuning set**). Translation performance is usually measured with Bleu, but the tuning algorithms all support (at least in principle) the use of other performance measures. Currently (July 2013) only the MERT implementation supports any metrics other than Bleu - it has support for TER, PER CDER and others as well as support for interpolations of metrics. The interest in sparse features has led to the development of new tuning algorithms, and Moses contains implementations of some of these.

For an extensive survey of tuning methods in MT, see Neubig and Watanabe, 2016<sup>34</sup>

There are essentially two classes of tuning algorithms used in statistical MT: **batch** and **online**. Examples of each of these classes of algorithms are listed in the following sections.

### 5.14.2 Batch tuning algorithms

Here the whole tuning set is decoded, usually generating an n-best list or a lattice, then the model weights are updated based on this decoder output. The tuning set is then re-decoded with the new weights, the optimisation repeated, and this iterative process continues until some convergence criterion is satisfied. All the batch algorithms in Moses are controlled by the inaccurately named `mert-moses.pl`, which runs the 'outer loop' (i.e. the repeated decodes). Running this script with no arguments displays usage information.

<sup>34</sup><http://www.phontron.com/paper/neubig16cl.pdf>

## MERT

Minimum error rate training (MERT) was introduced by Och (2003)<sup>35</sup>. For details on the Moses implementation, see Bertoldi et al, (2009)<sup>36</sup>. This line-search based method is probably still the most widely used tuning algorithm, and the default option in Moses. It does not support the use of more than about 20-30 features, so for sparse features you should use one of the other algorithms.

## Lattice MERT

A variant of MERT which uses lattices instead of n-best lists. This was implemented by Kārlis Goba and Christian Buck at the Fourth Machine Translation Marathon in January 2010. It is based on the work of Macherey et al. (2008)<sup>37</sup> and is available here<sup>38</sup>.

## PRO

Pairwise ranked optimization (Hopkins and May, 2011)<sup>39</sup> works by learning a weight set that ranks translation hypotheses in the same order as the metric (e.g. Bleu). Passing the argument `--pairwise-ranked` to `mert-moses.pl` enables PRO.

## Batch MIRA

Also known as k-best MIRA (Cherry and Foster, 2012)<sup>40</sup>, this is a version of MIRA (a margin-based classification algorithm) which works within a batch tuning framework. To use batch MIRA, you need to pass the `--batch-mira` argument to `mert-moses.pl`. See below (Section 5.14.5) for more detail.

### 5.14.3 Online tuning algorithms

These methods requires much tighter integration with the decoder. Each sentence in the tuning set is decoded in turn, and based on the results of the decode the weights are updated before decoding the next sentence. The algorithm may iterate through the tuning set multiple times.

## MIRA

The MIRA tuning algorithm (Chiang, 2012)<sup>41</sup>; (Hasler et al, 2011)<sup>42</sup> was inspired by the passive-aggressive algorithms of Koby Crammer, and their application to structured prediction by Ryan MacDonald. After decoding each sentence, MIRA updates the weights only if the metric ranks the output sentence with respect to a (pseudo-)reference translation differently from the model.

<sup>35</sup><http://www.aclweb.org/anthology/P/P03/P03-1021.pdf>

<sup>36</sup><http://homepages.inf.ed.ac.uk/bhaddow/prague-mert.pdf>

<sup>37</sup><http://research.google.com/pubs/pub34629.html>

<sup>38</sup><https://github.com/christianbuck/Moses-Lattice-MERT>

<sup>39</sup><http://www.aclweb.org/anthology/D11-1125.pdf>

<sup>40</sup><http://aclweb.org/anthology-new/N/N12/N12-1047.pdf>

<sup>41</sup><http://www.jmlr.org/papers/volume13/chiang12a/chiang12a.pdf>

<sup>42</sup><http://ufal.mff.cuni.cz/pbml/96/art-hasler-haddow-koehn.pdf>

### 5.14.4 Metrics

By default, tuning is optimizing the BLEU score of translating the specified tuning set. You can also use other metrics, and even combinations of metrics.

For instance,

```
mert-moses.pl [...] --mertargs="--sctype TER,BLEU --sconfig weights:0.6+0.4"
```

optimizes based on both the TER score and the BLEU score with a balance of 60

The following metrics are supported:

- BLEU - the popular **bi**lingual **e**valuation **u**nderstudy (Papineni et al., 2001<sup>43</sup>)
- BLEUDOC
- TER - edit distance with moves (Snover et al., 2006<sup>44</sup>)
- PER - position-independent word error rate (number of matching words)
- WER - word error rate (cannot deal with moves)
- CDER - word error rate with block movement (Leusch et al., 2006<sup>45</sup>)
- METEOR - recall oriented metric with stem / synonym matching (Lavie et al., 2007<sup>46</sup>)

### 5.14.5 Tuning in Practice

#### Multiple references

To specify multiple references to `mert-moses.pl`, name each reference file with a prefix followed by a number. Pass the prefix as the reference and ensure that the prefix does not exist.

#### ZMERT Tuning

Kamil Kos created `contrib/zmert-moses.pl`, a Java replacement for `mert-moses.pl` for those who wish to use ZMERT. The `zmert-moses.pl` script supports most of the `mert-moses.pl` parameters, therefore the transition to the new `zmert` version should be relatively easy. For more details on supported parameters run `zmert-moses.pl --help`.

ZMERT can support multiple metrics ZMERT homepage<sup>47</sup>. For instance, SemPOS<sup>48</sup> which is based on the tectogrammatical layer, see TectoMT<sup>49</sup>.

ZMERT JAR, version 1.41 needs to be downloaded from Omar Zaidan's website<sup>50</sup>. If you would like to add a new metric, please, modify the `zmert/zmert.jar` file in the following way:

<sup>43</sup><http://www.mt-archive.info/IBM-2001-Papineni.pdf>

<sup>44</sup><http://mt-archive.info/AMTA-2006-Snover.pdf>

<sup>45</sup><http://www.aclweb.org/anthology/E06-1031>

<sup>46</sup><http://www.aclweb.org/anthology/W/W07/W07-0734.pdf>

<sup>47</sup><http://www.cs.jhu.edu/~ozaidan/zmert/>

<sup>48</sup><http://ufal.mff.cuni.cz/pbml/92/art-pbml92-kos-bojar.pdf>

<sup>49</sup><http://ufal.mff.cuni.cz/tectomt>

<sup>50</sup><http://www.cs.jhu.edu/~ozaidan/zmert/>

1. extract `zmert.jar` content by typing `jar xf zmert.jar`
2. modify the files (probably a copy of `NewMetric.java.template`)
3. recompile java files by `javac *.java`
4. create a new version of `zmert.jar` by typing `jar cvfM zmert.jar *.java* *.class`

### k-best batch MIRA Tuning

This is hope-fear MIRA built as a drop-in replacement for MERT; it conducts online training using aggregated k-best lists as an approximation to the decoder's true search space. This allows it to handle large features, and it often out-performs MERT once feature counts get above 10.

You can tune using this system by adding `--batch-mira` to your `mert-moses.pl` command. This replaces the normal call to the `mert` executable with a call to `kbmira`.

I recommend also adding the flag `--return-best-dev` to `mert-moses.pl`. This will copy the `moses.ini` file corresponding to the highest-scoring development run (as determined by the evaluator executable using BLEU on `run*.out`) into the final `moses.ini`. This can make a fairly big difference for MIRA's test-time accuracy.

You can also pass through options to `kbmira` by adding `--batch-mira-args 'whatever'` to `mert-moses.pl`. Useful `kbmira` options include:

- `-J n`: changes the number of inner MIRA loops to `n` passes over the data. Increasing this value to 100 or 300 can be good for working with small development sets. The default, 60, is ideal for development sets with more than 1000 sentences.
- `-C n`: changes MIRA's C-value to `n`. This controls regularization. The default, 0.01, works well for most situations, but if it looks like MIRA is over-fitting or not converging, decreasing C to 0.001 or 0.0001 can sometimes help.
- `--streaming`: stream k-best lists from disk rather than load them into memory. This results in very slow training, but may be necessary in low-memory environments or with very large development sets.

Run `kbmira --help` for a full list of options.

So, a complete call might look like this:

```
$MOSES_SCRIPTS/training/mert-moses.pl work/dev.fr work/dev.en \
$MOSES_BIN/moses work/model/moses.ini --mertdir $MOSES_BIN \
--rootdir $MOSES_SCRIPTS --batch-mira --return-best-dev \
--batch-mira-args '-J 300' --decoder-flags '-threads 8 -v 0'
```

Please give it a try. If it's not working as advertised, send Colin Cherry an e-mail.

For more information on batch MIRA, check out the paper:

*Colin Cherry and George Foster*: "Batch Tuning Strategies for Statistical Machine Translation", NAACL, June 2012, pdf<sup>51</sup>

<sup>51</sup>[https://sites.google.com/site/colinacherry/Cherry\\_Foster\\_NAACL\\_2012.pdf](https://sites.google.com/site/colinacherry/Cherry_Foster_NAACL_2012.pdf)



Anticipating some questions:

[Q: Does it only handle BLEU?] [A: Yes, for now. There's nothing stopping people from implementing other metrics, so long as a reasonable sentence-level version of the metric can be worked out. Note that you generally need to retune kbmira's C-value for different metrics. I'd also change --return-best-dev to use the new metric as well.]

[Q: Have you tested this on a cluster?] [A: No, I don't have access to a Sun Grid cluster - I would love it if someone would test that scenario for me. But it works just fine using multi-threaded decoding. Since training happens in a batch, decoding is embarrassingly parallel.]

### **Tree-to-string and tree-to-tree tuning**

When tuning with tree input, make sure you set the inputtype argument to the mert script

```
mert-moses.pl --inputtype 3 ...
```

*Subsection last modified on June 13, 2016, at 02:01 PM*



# 6

## Background

### 6.1 Background

Statistical Machine Translation as a research area started in the late 1980s with the Candide project at IBM. IBM's original approach maps individual words to words and allows for deletion and insertion of words.

Lately, various researchers have shown better translation quality with the use of phrase translation. Phrase-based MT can be traced back to Och's alignment template model, which can be re-framed as a phrase translation system. Other researchers used augmented their systems with phrase translation, such as Yamada, who use phrase translation in a syntax-based model.

Marcu introduced a joint-probability model for phrase translation. At this point, most competitive statistical machine translation systems use phrase translation, such as the CMU, IBM, ISI, and Google systems, to name just a few. Phrase-based systems came out ahead at a recent international machine translation competition (DARPA TIDES Machine Translation Evaluation 2003-2006 on Chinese-English and Arabic-English).

Of course, there are other ways to do machine translation. Most commercial systems use transfer rules and a rich translation lexicon. Machine translation research was focused on transfer-based systems in the 1980s and on knowledge based systems that use an interlingua representation as an intermediate step between input and output in the 1990s.

There are also other ways to do statistical machine translation. There is some effort in building syntax-based models that either use real syntax trees generated by syntactic parsers, or tree transfer methods motivated by syntactic reordering patterns.

The phrase-based statistical machine translation model we present here was defined by Koehn et al. (2003)<sup>1</sup>. See also the description by Zens (2002)<sup>2</sup>. The alternative phrase-based methods differ in the way the phrase translation table is created, which we discuss in detail below.

---

<sup>1</sup><http://acl.ldc.upenn.edu/N/N03/N03-1017.pdf>

<sup>2</sup>[http://www.rzens.com/Zens\\_KI\\_2002.pdf](http://www.rzens.com/Zens_KI_2002.pdf)

### 6.1.1 Model

The figure below illustrates the process of phrase-based translation. The input is segmented into a number of sequences of consecutive words (so-called *phrases*). Each phrase is translated into an English phrase, and English phrases in the output may be reordered.

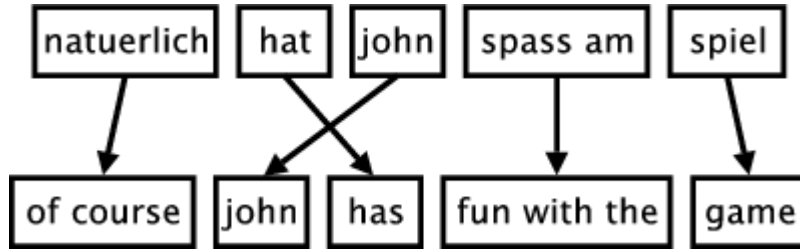

In this section, we will define the phrase-based machine translation model formally. The phrase translation model is based on the noisy channel model. We use Bayes rule to reformulate the translation probability for translating a foreign sentence  $\mathbf{f}$  into English  $\mathbf{e}$  as

$$\operatorname{argmax}_{\mathbf{e}} p(\mathbf{e}|\mathbf{f}) = \operatorname{argmax}_{\mathbf{e}} p(\mathbf{f}|\mathbf{e}) p(\mathbf{e})$$

This allows for a language model  $p(\mathbf{e})$  and a separate translation model  $p(\mathbf{f}|\mathbf{e})$ .

During decoding, the foreign input sentence  $\mathbf{f}$  is segmented into a sequence of  $I$  phrases  $\bar{f}_1^I$ . We assume a uniform probability distribution over all possible segmentations.

Each foreign phrase  $\bar{f}_i$  in  $\bar{f}_1^I$  is translated into an English phrase  $\bar{e}_i$ . The English phrases may be reordered. Phrase translation is modeled by a probability distribution  $\phi(\bar{f}_i|\bar{e}_i)$ . Recall that due to the Bayes rule, the translation direction is inverted from a modeling standpoint.

Reordering of the English output phrases is modeled by a relative distortion probability distribution  $d(\text{start}_i, \text{end}_{i-1})$ , where  $\text{start}_i$  denotes the start position of the foreign phrase that was translated into the  $i$ th English phrase, and  $\text{end}_{i-1}$  denotes the end position of the foreign phrase that was translated into the  $(i-1)$ th English phrase.

We use a simple distortion model  $d(\text{start}_i, \text{end}_{i-1}) = \alpha^{|\text{start}_i - \text{end}_{i-1}|}$  with an appropriate value for the parameter  $\alpha$ .

In order to calibrate the output length, we introduce a factor  $\omega$  (called word cost) for each generated English word in addition to the trigram language model  $p_{\text{LM}}$ . This is a simple means to optimize performance. Usually, this factor is larger than 1, biasing toward longer output.

In summary, the best English output sentence  $\mathbf{e}_{\text{best}}$  given a foreign input sentence  $\mathbf{f}$  according to our model is

$$\mathbf{e}_{\text{best}} = \operatorname{argmax}_{\mathbf{e}} p(\mathbf{e}|\mathbf{f}) = \operatorname{argmax}_{\mathbf{e}} p(\mathbf{f}|\mathbf{e}) p_{\text{LM}}(\mathbf{e}) \omega^{\text{length}(\mathbf{e})}$$

where  $p(\mathbf{f}|\mathbf{e})$  is decomposed into

$$p(\bar{f}_1^I|\bar{e}_1^I) = \Phi_{i=1}^I \phi(\bar{f}_i|\bar{e}_i) d(\text{start}_i, \text{end}_{i-1})$$

### 6.1.2 Word Alignment

When describing the phrase-based translation model so far, we did not discuss how to obtain the model parameters, especially the phrase probability translation table that maps foreign phrases to English phrases.

Most recently published methods on extracting a phrase translation table from a parallel corpus start with a word alignment. Word alignment is an active research topic. For instance, this problem was the focus as a shared task at a recent data driven machine translation workshop<sup>3</sup>. See also the systematic comparison by Och and Ney (Computational Linguistics, 2003).

At this point, the most common tool to establish a word alignment is to use the toolkit GIZA++<sup>4</sup>. This toolkit is an implementation of the original IBM models that started statistical machine translation research. However, these models have some serious draw-backs. Most importantly, they only allow at most one English word to be aligned with each foreign word. To resolve this, some transformations are applied.

First, the parallel corpus is aligned bidirectionally, e.g., Spanish to English and English to Spanish. This generates two word alignments that have to be reconciled. If we intersect the two alignments, we get a high-precision alignment of high-confidence alignment points. If we take the union of the two alignments, we get a high-recall alignment with additional alignment points. See the figure below for an illustration.

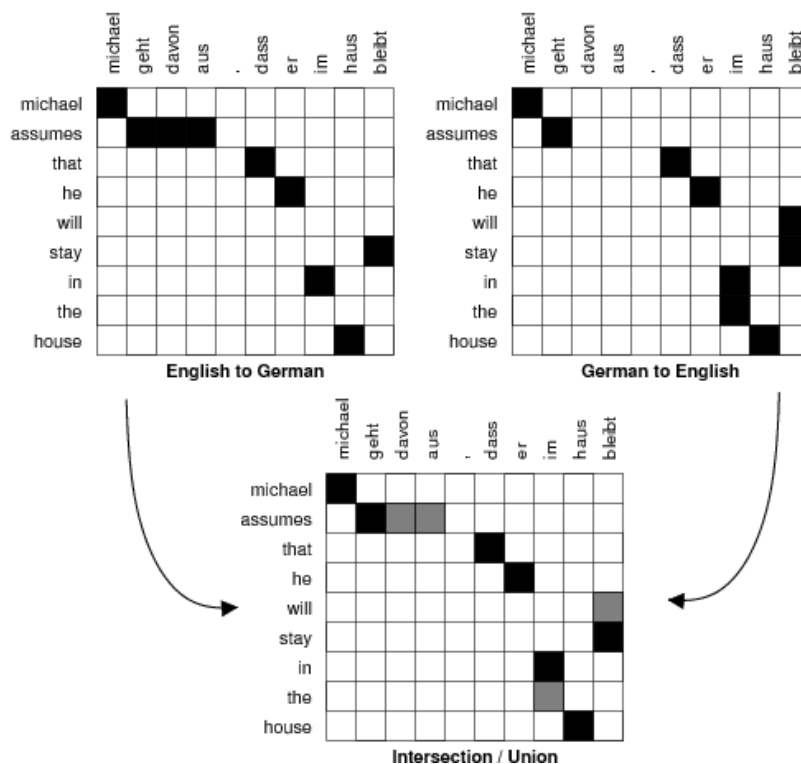

Researchers differ in their methods where to go from here. We describe the details below.

<sup>3</sup><http://www.statmt.org/wpt05/>

<sup>4</sup><http://www.isi.edu/~och/GIZA++.html>

### 6.1.3 Methods for Learning Phrase Translations

Most of the recently proposed methods use a word alignment to learn a phrase translation table. We discuss three such methods in this section and one exception.

#### Marcu and Wong

First, the exception: Marcu and Wong (EMNLP, 2002) proposed to establish phrase correspondences directly in a parallel corpus. To learn such correspondences, they introduced a phrase-based joint probability model that simultaneously generates both the source and target sentences in a parallel corpus.

Expectation Maximization learning in Marcu and Wong's framework yields both (i) a joint probability distribution  $\phi(\bar{e}, \bar{f})$ , which reflects the probability that phrases  $\bar{e}$  and  $\bar{f}$  are translation equivalents; (ii) and a joint distribution  $d(i,j)$ , which reflects the probability that a phrase at position  $i$  is translated into a phrase at position  $j$ .

To use this model in the context of our framework, we simply marginalize the joint probabilities estimated by Marcu and Wong (EMNLP, 2002) to conditional probabilities. Note that this approach is consistent with the approach taken by Marcu and Wong themselves, who use conditional models during decoding.

#### 6.1.4 Och and Ney

Och and Ney (Computational Linguistics, 2003) propose a heuristic approach to refine the alignments obtained from GIZA++. At a minimum, all alignment points of the intersection of the two alignments are maintained. At a maximum, the points of the union of the two alignments are considered. To illustrate this, see the figure below. The intersection points are black, the additional points in the union are shaded grey.

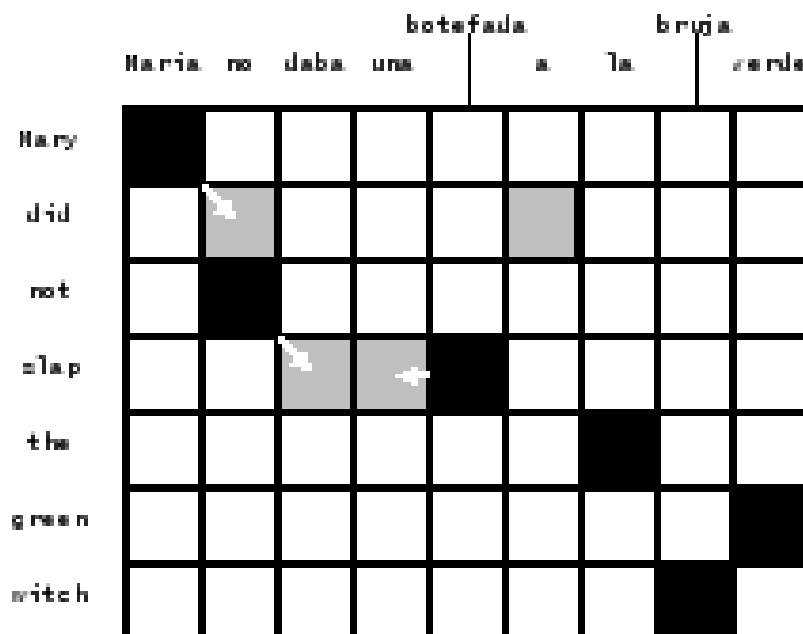

Och and Ney explore the space between intersection and union with expansion heuristics that start with the intersection and add additional alignment points. The decision which points to add may depend on a number of criteria:

- In which alignment does the potential alignment point exist? Foreign-English or English-foreign?
- Does the potential point neighbor already established points?
- Does *neighboring* mean directly adjacent (block-distance), or also diagonally adjacent?
- Is the English or the foreign word that the potential point connects unaligned so far? Are both unaligned?
- What is the lexical probability for the potential point?

Och and Ney (Computational Linguistics, 2003) are ambiguous in their description about which alignment points are added in their refined method. We reimplemented their method for Moses, so we will describe this interpretation here.

Our heuristic proceeds as follows: We start with intersection of the two word alignments. We only add new alignment points that exist in the union of two word alignments. We also always require that a new alignment point connects at least one previously unaligned word.

First, we expand to only directly adjacent alignment points. We check for potential points starting from the top right corner of the alignment matrix, checking for alignment points for the first English word, then continue with alignment points for the second English word, and so on.

This is done iteratively until no alignment point can be added anymore. In a final step, we add non-adjacent alignment points, with otherwise the same requirements.

We collect all aligned phrase pairs that are consistent with the word alignment: The words in a legal phrase pair are only aligned to each other, and not to words outside. The set of bilingual phrases **BP** can be defined formally (Zens, KI 2002) as:

$$BP(f_1^J, e_1^J, A) = \{(f_j^{j+m}, e_i^{i+n})\} : \forall (i', j') \in A : j \leq j' \leq j + m \leftrightarrow i \leq i' \leq i + m$$

See the figure below for some examples what this means. All alignment points for words that are part of the phrase pair have to be in the phrase alignment box. It is fine to have unaligned words in a phrase alignment, even at the boundary.

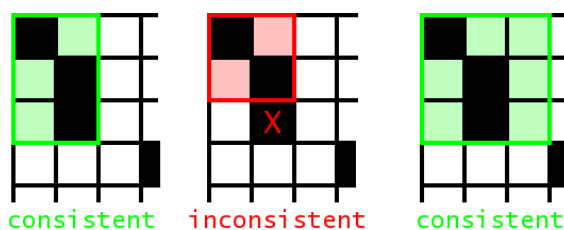

The figure below displays all the phrase pairs that are collected according to this definition for the alignment from our running example.

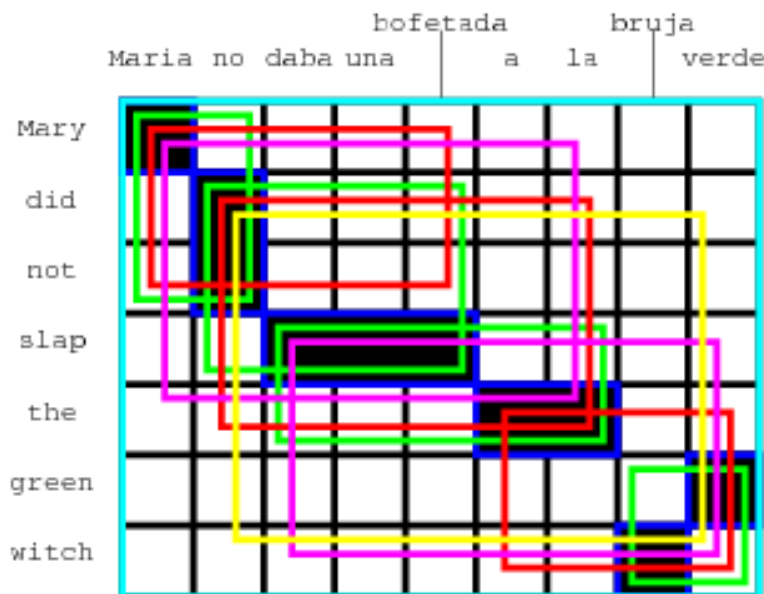

(Maria, Mary), (no, did not), (slap, daba una bofetada), (a la, the), (bruja, witch), (verde, green), (Maria no, Mary did not), (no daba una bofetada, did not slap), (daba una bofetada a la, slap the), (bruja verde, green witch), (Maria no daba una bofetada, Mary did not slap), (no daba una bofetada a la, did not slap the), (a la bruja verde, the green witch) (Maria no daba una bofetada a la, Mary did not slap the), (daba una bofetada a la bruja verde, slap the green witch), (no daba una bofetada a la bruja verde, did not slap the green witch), (Maria no daba una bofetada a la bruja verde, Mary did not slap the green witch)

Given the collected phrase pairs, we estimate the phrase translation probability distribution by relative frequency:  $\phi(\bar{f}|\bar{e}) = \text{count}(\bar{f},\bar{e}) / \sum_{\bar{f}} \text{count}(\bar{f},\bar{e})$

No smoothing is performed, although lexical weighting addresses the problem of sparse data. For more details, see our paper on phrase-based translation (Koehn et al, HLT-NAACL 2003).

### Tillmann

Tillmann (EMNLP, 2003) proposes a variation of this method. He starts with phrase alignments based on the intersection of the two GIZA++ alignments and uses points of the union to expand these. See his presentation for details.

### Venugopal, Zhang, and Vogel

Venugopal et al. (ACL 2003) allows also for the collection of phrase pairs that are violated by the word alignment. They introduce a number of scoring methods take consistency with the word alignment, lexical translation probabilities, phrase length, etc. into account.

Zhang et al. (2003) proposes a phrase alignment method that is based on word alignments and tries to find a unique segmentation of the sentence pair, as it is done by Marcu and Wong directly. This enables them to estimate joint probability distributions, which can be marginalized into conditional probability distributions.

Vogel et al. (2003) reviews these two methods and shows that the combining phrase tables generated by different methods improves results.



## 6.2 Decoder

This section describes the Moses decoder from a more theoretical perspective. The decoder was originally developed for the phrase model proposed by Marcu and Wong. At that time, only a greedy hill-climbing decoder was available, which was insufficient for our work on noun phrase translation (Koehn, PhD, 2003).

The decoder implements a beam search and is roughly similar to work by Tillmann (PhD, 2001) and Och (PhD, 2002). In fact, by reframing Och’s alignment template model as a phrase translation model, the decoder is also suitable for his model, as well as other recently proposed phrase models.

We start this section with defining the concept of translation options, describe the basic mechanism of beam search, and its necessary components: pruning, future cost estimates. We conclude with background on n-best list generation.

### 6.2.1 Translation Options

Given an input string of words, a number of phrase translations could be applied. We call each such applicable phrase translation a *translation option*. This is illustrated in the figure below, where a number of phrase translations for the Spanish input sentence *Maria no daba una bofetada a la bruja verde* are given.

Maria	no	daba	una	bofetada	a	la	bruja	verde
Mary	not	give	a	slap	to	the	witch	green
	did not		a slap		by		green witch	
	no		slap		to the			
	did not give				to			
					the			
			slap			the witch		

These translation options are collected before any decoding takes place. This allows a quicker lookup than consulting the whole phrase translation table during decoding. The translation options are stored with the information

- first foreign word covered
- last foreign word covered
- English phrase translation
- phrase translation probability

Note that only the translation options that can be applied to a given input text are necessary for decoding. Since the entire phrase translation table may be too big to fit into memory, we can restrict ourselves to these translation options to overcome such computational concerns. We may even generate a phrase translation table on demand that only includes valid translation options for a given input text. This way, a full phrase translation table (that may be computationally too expensive to produce) may never have to be built.

### 6.2.2 Core Algorithm

The phrase-based decoder we developed employs a beam search algorithm, similar to the one used by Jelinek (book "Statistical Methods for Speech Recognition", 1998) for speech recognition. The English output sentence is generated left to right in form of hypotheses.

This process illustrated in the figure below. Starting from the initial hypothesis, the first expansion is the foreign word *Maria*, which is translated as *Mary*. The foreign word is marked as translated (marked by an asterisk). We may also expand the initial hypothesis by translating the foreign word *bruja* as *witch*.

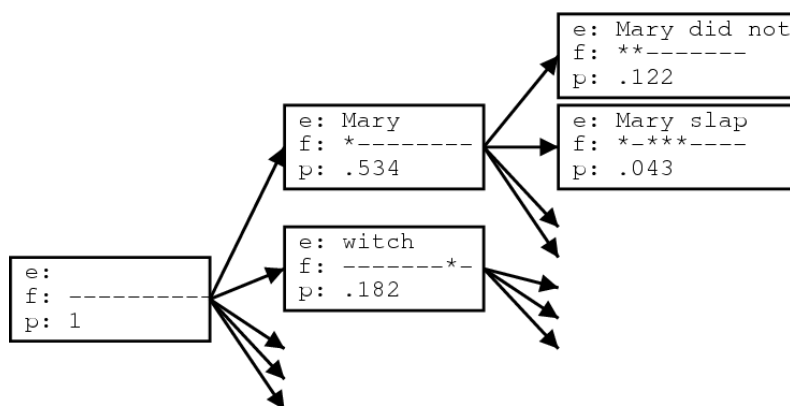

We can generate new hypotheses from these expanded hypotheses. Given the first expanded hypothesis we generate a new hypothesis by translating *no* with *did not*. Now the first two foreign words *Maria* and *no* are marked as being covered. Following the back pointers of the hypotheses we can read off the (partial) translations of the sentence.

Let us now describe the beam search more formally. We begin the search in an initial state where no foreign input words are translated and no English output words have been generated. New states are created by extending the English output with a phrasal translation of that covers some of the foreign input words not yet translated.

The current cost of the new state is the cost of the original state multiplied with the translation, distortion and language model costs of the added phrasal translation. Note that we use the informal concept *cost* analogous to probability: A high cost is a low probability.

Each search state (hypothesis) is represented by

- a back link to the best previous state (needed for finding the best translation of the sentence by back-tracking through the search states)
- the foreign words covered so far
- the last two English words generated (needed for computing future language model costs)
- the end of the last foreign phrase covered (needed for computing future distortion costs)
- the last added English phrase (needed for reading the translation from a path of hypotheses)
- the cost so far
- an estimate of the future cost (is precomputed and stored for efficiency reasons, as detailed in below in special section)

Final states in the search are hypotheses that cover all foreign words. Among these the hypothesis with the lowest cost (highest probability) is selected as best translation.

The algorithm described so far can be used for exhaustively searching through all possible translations. In the next sections we will describe how to optimize the search by discarding hypotheses that cannot be part of the path to the best translation. We then introduce the concept of comparable states that allow us to define a beam of good hypotheses and prune out hypotheses that fall out of this beam. In a later section, we will describe how to generate an (approximate) n-best list.

### 6.2.3 Recombining Hypotheses

Recombining hypothesis is a risk-free way to reduce the search space. Two hypotheses can be recombined if they agree in

- the foreign words covered so far
- the last two English words generated
- the end of the last foreign phrase covered

If there are two paths that lead to two hypotheses that agree in these properties, we keep only the cheaper hypothesis, e.g., the one with the least cost so far. The other hypothesis cannot be part of the path to the best translation, and we can safely discard it.

Note that the inferior hypothesis can be part of the path to the second best translation. This is important for generating n-best lists.

### 6.2.4 Beam Search

While the recombination of hypotheses as described above reduces the size of the search space, this is not enough for all but the shortest sentences. Let us estimate how many hypotheses (or, states) are generated during an exhaustive search. Considering the possible values for the properties of unique hypotheses, we can estimate an upper bound for the number of states by  $N \sim 2^{n_f} |V_e|^2 n_f$  where  $n_f$  is the number of foreign words, and  $|V_e|$  the size of the English vocabulary. In practice, the number of possible English words for the last two words generated is much smaller than  $|V_e|^2$ . The main concern is the exponential explosion from the  $2^{n_f}$  possible configurations of foreign words covered by a hypothesis. Note this causes the problem of machine translation to become NP-complete (Knight, Computational Linguistics, 1999) and thus dramatically harder than, for instance, speech recognition.

In our beam search we compare the hypotheses that cover the same *number* of foreign words and prune out the inferior hypotheses. We could base the judgment of what inferior hypotheses are on the cost of each hypothesis so far. However, this is generally a very bad criterion, since it biases the search to first translating the easy part of the sentence. For instance, if there is a three word foreign phrase that easily translates into a common English phrase, this may carry much less cost than translating three words separately into uncommon English words. The search will prefer to start the sentence with the easy part and discount alternatives too early.

So, our measure for pruning out hypotheses in our beam search does not only include the cost so far, but also an estimate of the future cost. This future cost estimation should favor hypotheses that already covered difficult parts of the sentence and have only easy parts left,

and discount hypotheses that covered the easy parts first. We describe the details of our future cost estimation in the next section.

Given the cost so far and the future cost estimation, we can prune out hypotheses that fall outside the beam. The beam size can be defined by threshold and histogram pruning. A relative threshold cuts out a hypothesis with a probability less than a factor  $\alpha$  of the best hypotheses (e.g.,  $\alpha = 0.001$ ). Histogram pruning keeps a certain number  $n$  of hypotheses (e.g.,  $n = 100$ ).

Note that this type of pruning is not risk-free (opposed to the recombination, which we described earlier). If the future cost estimates are inadequate, we may prune out hypotheses on the path to the best scoring translation. In a particular version of beam search, A\* search, the future cost estimate is required to be *admissible*, which means that it never overestimates the future cost. Using best-first search and an admissible heuristic allows pruning that is risk-free. In practice, however, this type of pruning does not sufficiently reduce the search space. See more on search in any good Artificial Intelligence text book, such as the one by Russel and Norvig ("Artificial Intelligence: A Modern Approach").

The figure below gives pseudo-code for the algorithm we used for our beam search. For each number of foreign words covered, a hypothesis stack is created. The initial hypothesis is placed in the stack for hypotheses with no foreign words covered. Starting with this hypothesis, new hypotheses are generated by committing to phrasal translations that covered previously unused foreign words. Each derived hypothesis is placed in a stack based on the number of foreign words it covers.

```

initialize hypothesisStack[0 .. nf];
create initial hypothesis hyp_init;
add to stack hypothesisStack[0];
for i=0 to nf-1:
  for each hyp in hypothesisStack[i]:
    for each new_hyp that can be derived from hyp:
      nf[new_hyp] = number of foreign words covered by new_hyp;
      add new_hyp to hypothesisStack[nf[new_hyp]];
      prune hypothesisStack[nf[new_hyp]];
  find best hypothesis best_hyp in hypothesisStack[nf];
output best path that leads to best_hyp;

```

We proceed through these hypothesis stacks, going through each hypothesis in the stack, deriving new hypotheses for this hypothesis and placing them into the appropriate stack (see figure below for an illustration). After a new hypothesis is placed into a stack, the stack may have to be pruned by threshold or histogram pruning, if it has become too large. In the end, the best hypothesis of the ones that cover all foreign words is the final state of the best translation. We can read off the English words of the translation by following the back links in each hypothesis.

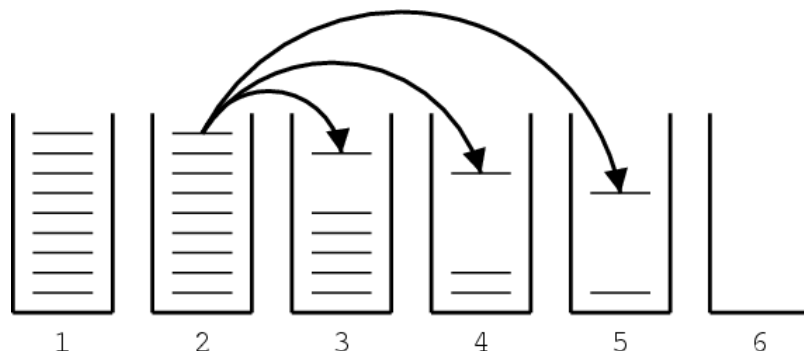

### 6.2.5 Future Cost Estimation

Recall that for excluding hypotheses from the beam we do not only have to consider the cost so far, but also an estimate of the future cost. While it is possible to calculate the cheapest possible future cost for each hypothesis, this is computationally so expensive that it would defeat the purpose of the beam search.

The future cost is tied to the foreign words that are not yet translated. In the framework of the phrase-based model, not only may single words be translated individually, but also consecutive sequences of words as a phrase.

Each such translation operation carries a translation cost, language model costs, and a distortion cost. For our future cost estimate we consider only translation and language model costs. The language model cost is usually calculated by a trigram language model. However, we do not know the preceding English words for a translation operation. Therefore, we approximate this cost by computing the language model score for the generated English words alone. That means, if only one English word is generated, we take its unigram probability. If two words are generated, we take the unigram probability of the first word and the bigram probability of the second word, and so on.

For a sequence of foreign words multiple overlapping translation options exist. We just described how we calculate the cost for each translation option. The cheapest way to translate the sequence of foreign words includes the cheapest translation options. We approximate the cost for a path through translation options by the product of the cost for each option.

To illustrate this concept, refer to the figure below. The translation options cover different consecutive foreign words and carry an estimated cost  $c_{ij}$ . The cost of the shaded path through the sequence of translation options is  $c_{01}c_{12}c_{25} = 1.9578 \cdot 10^{-7}$ .

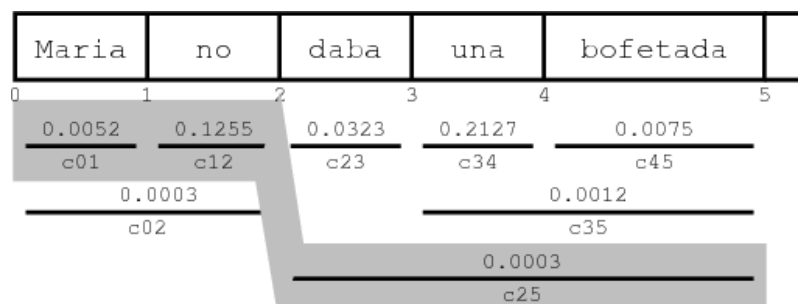

The cheapest path for a sequence of foreign words can be quickly computed with dynamic programming. Also note that if the foreign words not covered so far are two (or more) disconnected sequences of foreign words, the combined cost is simply the product of the costs for each contiguous sequence. Since there are only  $n(n+1)/2$  contiguous sequences for  $n$  words, the future cost estimates for these sequences can be easily precomputed and cached for each input sentence. Looking up the future costs for a hypothesis can then be done very quickly by table lookup. This has considerable speed advantages over computing future cost on the fly.

### 6.2.6 N-Best Lists Generation

Usually, we expect the decoder to give us the best translation for a given input according to the model. But for some applications, we might also be interested in the second best translation, third best translation, and so on.

A common method in speech recognition, that has also emerged in machine translation is to first use a machine translation system such as our decoder as a base model to generate a set of candidate translations for each input sentence. Then, additional features are used to rescore these translations.

An n-best list is one way to represent multiple candidate translations. Such a set of possible translations can also be represented by word graphs (Ueffing et al., EMNLP 2002) or forest structures over parse trees (Langkilde, EACL 2002). These alternative data structures allow for more compact representation of a much larger set of candidates. However, it is much harder to detect and score global properties over such data structures.

#### Additional Arcs in the Search Graph

Recall the process of state expansions. The generated hypotheses and the expansions that link them form a graph. Paths branch out when there are multiple translation options for a hypothesis from which multiple new hypotheses can be derived. Paths join when hypotheses are recombined.

Usually, when we recombine hypotheses, we simply discard the worse hypothesis, since it cannot possibly be part of the best path through the search graph (in other words, part of the best translation).

But since we are now also interested in the second best translation, we cannot simply discard information about that hypothesis. If we would do this, the search graph would only contain one path for each hypothesis in the last hypothesis stack (which contains hypotheses that cover all foreign words).

If we store information that there are multiple ways to reach a hypothesis, the number of possible paths also multiplies along the path when we traverse backward through the graph.

In order to keep the information about merging paths, we keep a record of such merges that contains

- identifier of the previous hypothesis
- identifier of the lower-cost hypothesis
- cost from the previous to higher-cost hypothesis

The figure below gives an example for the generation of such an arc: in this case, the hypotheses 2 and 4 are equivalent in respect to the heuristic search, as detailed above. Hence, hypothesis 4 is deleted. But since we want to keep the information about the path leading from hypothesis 3 to 2, we store a record of this arc. The arc also contains the cost added from hypothesis 3 to 4. Note that the cost from hypothesis 1 to hypothesis 2 does not have to be stored, since it can be recomputed from the hypothesis data structures.

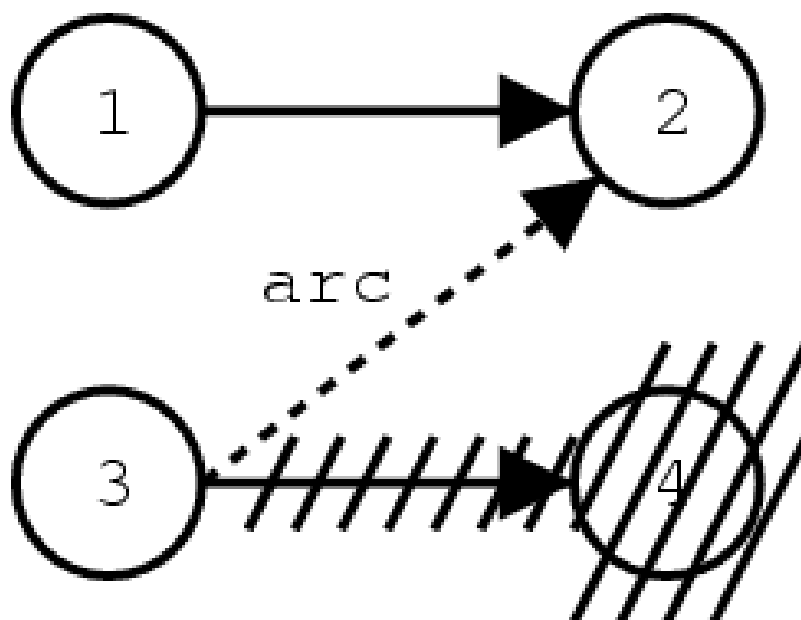

### Mining the Search Graph for an n-Best List

The graph of the hypothesis space can be also be viewed as a probabilistic finite state automaton. The hypotheses are states, and the records of back-links and the additionally stored arcs are state transitions. The added probability scores when expanding a hypothesis are the costs of the state transitions.

Finding the n-best path in such a probabilistic finite state automaton is a well-studied problem. In our implementation, we store the information about hypotheses, hypothesis transitions, and additional arcs in a file that can be processed by the finite state toolkit Carmel<sup>5</sup>, which we use to mine the n-best lists. This toolkit uses the `_n_` shortest paths algorithm by Eppstein (FOCS, 1994).

Our method is related to work by Ueffing (2002) for generating n-best lists for IBM Model 4.

*Subsection last modified on July 28, 2013, at 09:56 AM*

<sup>5</sup><http://www.isi.edu/licensed-sw/carmel/>

### 6.3 Factored Translation Models

The current state-of-the-art approach to statistical machine translation, so-called phrase-based models, are limited to the mapping of small text chunks (phrases) without any explicit use of linguistic information, may it be morphological, syntactic, or semantic. Such additional information has been demonstrated to be valuable by integrating it in pre-processing or post-processing.

However, a tighter integration of linguistic information into the translation model is desirable for two reasons:

- Translation models that operate on more general representations, such as lemmas instead of surface forms of words, can draw on richer statistics and overcome the data sparseness problems caused by limited training data.
- Many aspects of translation can be best explained on a morphological, syntactic, or semantic level. Having such information available to the translation model allows the direct modeling of these aspects. For instance: reordering at the sentence level is mostly driven by general syntactic principles, local agreement constraints show up in morphology, etc.

Therefore, we developed a framework for statistical translation models that tightly integrates additional information. Our framework is an extension of the phrase-based approach. It adds additional annotation at the word level. A word in our framework is not anymore only a token, but a vector of factors that represent different levels of annotation (see figure below).

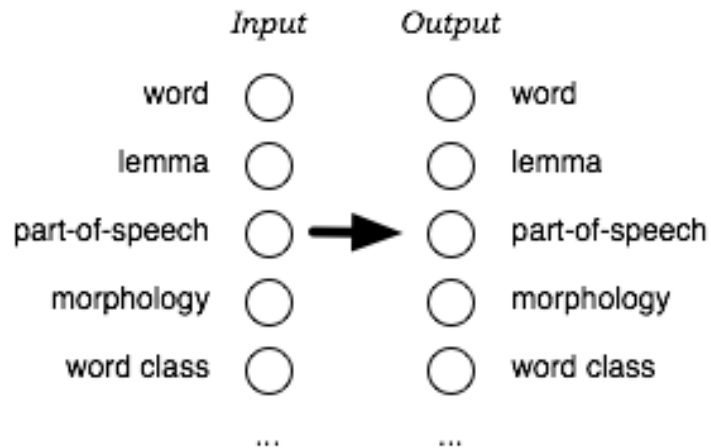

#### 6.3.1 Motivating Example: Morphology

One example to illustrate the short-comings of the traditional surface word approach in statistical machine translation is the poor handling of morphology. Each word form is treated as a token in itself. This means that the translation model treats, say, the word *house* completely independent of the word *houses*. Any instance of *house* in the training data does not add any knowledge to the translation of *houses*.

In the extreme case, while the translation of *house* may be known to the model, the word *houses* may be unknown and the system will not be able to translate it. While this problem does not



show up as strongly in English - due to the very limited morphological production in English - it does constitute a significant problem for morphologically rich languages such as Arabic, German, Czech, etc.

Thus, it may be preferable to model translation between morphologically rich languages on the level of lemmas, and thus pooling the evidence for different word forms that derive from a common lemma. In such a model, we would want to translate lemma and morphological information separately, and combine this information on the output side to ultimately generate the output surface words.

Such a model can be defined straight-forward as a factored translation model. See figure below for an illustration of this model in our framework.

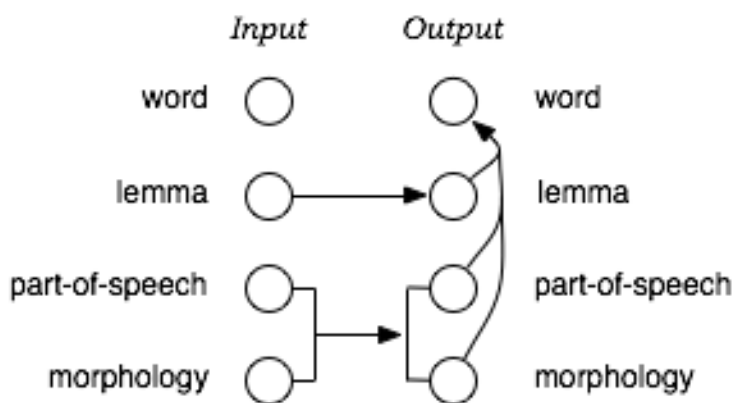

Note that while we illustrate the use of factored translation models on such a linguistically motivated example, our framework also applies to models that incorporate statistically defined word classes, or any other annotation.

### 6.3.2 Decomposition of Factored Translation

The translation of factored representations of input words into the factored representations of output words is broken up into a sequence of **mapping steps** that either **translate** input factors into output factors, or **generate** additional output factors from existing output factors.

Recall the example of a factored model motivated by morphological analysis and generation. In this model the translation process is broken up into the following three mapping steps:

- **Translate** input lemmas into output lemmas
- **Translate** morphological and POS factors
- **Generate** surface forms given the lemma and linguistic factors

Factored translation models build on the phrase-based approach, which defines a segmentation of the input and output sentences into phrases. Our current implementation of factored translation models follows strictly the phrase-based approach, with the additional decomposition of phrase translation into a sequence of mapping steps. Since all mapping steps operate on the same phrase segmentation of the input and output sentence into phrase pairs, we call these **synchronous factored models**.

Let us now take a closer look at one example, the translation of the one-word phrase *h"aus* into English. The representation of *h"aus* in German is: surface-form *h"aus* | lemma *haus* | part-of-speech *NN* | count *plural* | case *nominative* | gender *neutral*.

The three mapping steps in our morphological analysis and generation model may provide the following applicable mappings:

- **Translation:** Mapping lemmas
  - *haus* -> *house, home, building, shell*
- **Translation:** Mapping morphology
  - *NN|plural-nominative-neutral* -> *NN|plural, NN|singular*
- **Generation:** Generating surface forms
  - *house|NN|plural* -> *houses*
  - *house|NN|singular* -> *house*
  - *home|NN|plural* -> *homes*
  - ...

We call the application of these mapping steps to an input phrase **expansion**. Given the multiple choices for each step (reflecting the ambiguity in translation), each input phrase may be expanded into a list of translation options. The German *h"aus|haus|NN|plural-nominative-neutral* may be expanded as follows:

- **Translation:** Mapping lemmas
  - { *?|house|?|?, ?|home|?|?, ?|building|?|?, ?|shell|?|?* }
- **Translation:** Mapping morphology
  - { *?|house|NN|plural, ?|home|NN|plural, ?|building|NN|plural, ?|shell|NN|plural, ?|house|NN|singular, ...* }
- **Generation:** Generating surface forms
  - { *houses|house|NN|plural, homes|home|NN|plural, buildings|building|NN|plural, shells|shell|NN|plural, house|house|NN|singular, ...* }

### 6.3.3 Statistical Model

Factored translation models follow closely the statistical modeling approach of phrase-based models (in fact, phrase-based models are a special case of factored models). The main difference lies in the preparation of the training data and the type of models learned from the data.

#### Training

The training data (a parallel corpus) has to be annotated with the additional factors. For instance, if we want to add part-of-speech information on the input and output side, we need to obtain part-of-speech tagged training data. Typically this involves running automatic tools on the corpus, since manually annotated corpora are rare and expensive to produce.

Next, we need to establish a word-alignment for all the sentences in the parallel training corpus. Here, we use the same methodology as in phrase-based models (symmetrized GIZA++ alignments). The word alignment methods may operate on the surface forms of words, or on any of the other factors. In fact, some preliminary experiments have shown that word alignment based on lemmas or stems yields improved alignment quality.

Each mapping step forms a component of the overall model. From a training point of view this means that we need to learn translation and generation tables from the word-aligned parallel corpus and define scoring methods that help us to choose between ambiguous mappings.

Phrase-based translation models are acquired from a word-aligned parallel corpus by extracting all phrase-pairs that are consistent with the word alignment. Given the set of extracted phrase pairs with counts, various **scoring functions** are estimated, such as conditional phrase translation probabilities based on relative frequency estimation or lexical translation probabilities based on the words in the phrases.

In our approach, the models for the translation steps are acquired in the same manner from a word-aligned parallel corpus. For the specified factors in the input and output, phrase mappings are extracted. The set of phrase mappings (now over factored representations) is scored based on relative counts and word-based translation probabilities.

The tables for generation steps are estimated on the output side only. The word alignment plays no role here. In fact, additional monolingual data may be used. The generation model is learned on a word-for-word basis. For instance, for a generation step that maps surface forms to part-of-speech, a table with entries such as (*fish*, *NN*) is constructed. One or more scoring functions may be defined over this table, in our experiments we used both conditional probability distributions, e.g.,  $p(\textit{fish}|\textit{NN})$  and  $p(\textit{NN}|\textit{fish})$ , obtained by maximum likelihood estimation.

An important component of statistical machine translation is the language model, typically an n-gram model over surface forms of words. In the framework of factored translation models, such sequence models may be defined over any factor, or any set of factors. For factors such as part-of-speech tags, building and using higher order n-gram models (7-gram, 9-gram) is straight-forward.

### Combination of Components

As in phrase-based models, factored translation models can be seen as the combination of several components (language model, reordering model, translation steps, generation steps). These components define one or more feature functions that are combined in a log-linear model:

$$\mathbf{e}|\mathbf{f} = \exp \sum_{i=1}^n \lambda_i h_i(\mathbf{e}, \mathbf{f})$$

To compute the probability of a translation  $\mathbf{e}$  given an input sentence  $\mathbf{f}$ , we have to evaluate each feature function  $h_i$ . For instance, the feature function for a bigram language model component is ( $m$  is the number of words  $e_i$  in the sentence  $\mathbf{e}$ ):

$$h_{1m}(\mathbf{e}, \mathbf{f}) = p_{1m}(\mathbf{e}) = p(e_1)p(e_2|p_1)\dots p(e_m|e_{m-1})$$

Let us now consider the feature functions introduced by the translation and generation steps of factored translation models. The translation of the input sentence  $\mathbf{f}$  into the output sentence  $\mathbf{e}$  breaks down to a set of phrase translations  $(\bar{f}_j, \bar{e}_j)$ .

For a translation step component, each feature function  $h_t$  is defined over the phrase pairs  $(\bar{f}_j, \bar{e}_j)$  given a scoring function  $\tau$ :

$$h_t(\mathbf{e}, \mathbf{f}) = \sum_j \tau(\bar{f}_j, \bar{e}_j)''$$

For a generation step component, each feature function  $h_g$  given a scoring function  $\gamma$  is defined over the output words  $e_k$  only:

$$h_g(\mathbf{e}, \mathbf{f}) = \sum_k \gamma(e_k)$$

The feature functions follow from the scoring functions  $(\tau, \gamma)$  acquired during the training of translation and generation tables. For instance, recall our earlier example: a scoring function for a generation model component that is a conditional probability distribution between input and output factors, e.g.,  $\gamma(\text{fish}, NN, \text{singular}) = p(NN|\text{fish})$ .

The feature weights  $\lambda_i$  in the log-linear model are determined with the usual minimum error rate training method.

### Efficient Decoding

Compared to phrase-based models, the decomposition of phrase translation into several mapping steps creates additional computational complexity. Instead of a simple table lookup to obtain the possible translations for an input phrase, now multiple tables have to be consulted and their content combined.

In phrase-based models it is easy to identify the entries in the phrase table that may be used for a specific input sentence. These are called **translation options**. We usually limit ourselves to the top 20 translation options for each input phrase.

The beam search decoding algorithm starts with an empty hypothesis. Then new hypotheses are generated by using all applicable translation options. These hypotheses are used to generate further hypotheses in the same manner, and so on, until hypotheses are created that cover the full input sentence. The highest scoring complete hypothesis indicates the best translation according to the model.

How do we adapt this algorithm for factored translation models? Since all mapping steps operate on the same segmentation, the **expansions** of these mapping steps can be efficiently pre-computed prior to the heuristic beam search, and stored as translation options. For a given input phrase, all possible translation options are thus computed before decoding (recall the earlier example, where we carried out the expansion for one input phrase). This means that the fundamental search algorithm does not change.

However, we need to be careful about combinatorial explosion of the number of translation options given a sequence of mapping steps. In other words, the expansion may create too many translation options to handle. If one or many mapping steps result in a vast increase of (intermediate) expansions, this may become unmanageable. We currently address this problem by early pruning of expansions, and limiting the number of translation options per input phrase to a maximum number, by default 50. This is, however, not a perfect solution.

## 6.4 Confusion Networks Decoding

Machine translation input currently takes the form of simple sequences of words. However, there are increasing demands to integrate machine translation technology in larger information processing systems with upstream natural language and/or speech processing tools (such as named entity recognizers, automatic speech recognizers, morphological analyzers, etc.). These upstream processes tend to generate multiple, erroneous hypotheses with varying confidence. Current MT systems are designed to process only one input hypothesis, making them vulnerable to errors in the input. We extend current MT decoding methods to process multiple, ambiguous hypotheses in the form of an input lattice. A lattice representation allows an MT system to arbitrate between multiple ambiguous hypotheses from upstream processing so that the best translation can be produced.

As lattice has usually a complex topology, an approximation of it, called **confusion network**, is used instead. The extraction of a confusion network from a lattice can be performed by means of a publicly available `lattice-tool` contained in the **SRILM toolkit**. See the SRILM manual pages<sup>6</sup> for details and user guide.

### 6.4.1 Confusion Networks

A **Confusion Network (CN)**, also known as a **sausage**, is a weighted directed graph with the peculiarity that each path from the start node to the end node goes through all the other nodes.

Each edge is labeled with a word and a (posterior) probability. The total probability of all edges between two consecutive nodes sum up to 1. Notice that this is not a strict constraint from the point of view of the decoder; any score can be provided. A path from the start node to the end node is scored by multiplying the scores of its edges. If the previous constrain is satisfied, the product represents the likelihood of the path, and the sum of the likelihood of all paths equals to 1.

Between any two consecutive nodes, one (at most) special word `_eps_` can be inserted; `_eps_` words allows paths having different lengths.

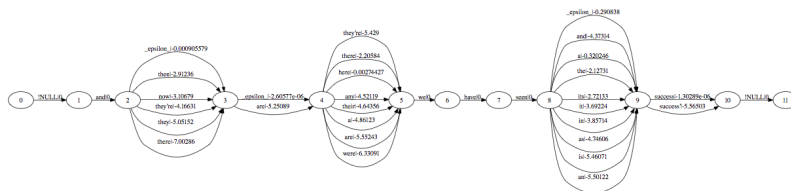

Any path within a CN represents a **realization** of the CN. Realizations of a CN can differ in terms of either sequence of words or total score. It is possible that two (or more) realizations have the same sequence of words, but different scores. Word lengths can also differ due to presence of the `_eps_`. This is a list of some realization of the previous CN.

<sup>6</sup><http://www.speech.sri.com/projects/srilm/manpages>

aus der Zeitung	score=0.252	length=3
Aus der Zeitung	score=0.126	length=3
Zeitung	score=0.021	length=1
Haus Zeitungs	score=0.001	length=2

### Notes

- A CN contains all paths of the lattice which is originated from.
- A CN can contain more paths than the lattice which is originated from (due `_eps_`).

### 6.4.2 Representation of Confusion Network

Moses adopts the following computer-friendly representation for a CN.

```
Haus 0.1 aus 0.4 _eps_ 0.3 Aus 0.2
der 0.9 _eps_ 0.1
Zeitung 0.7 _eps_ 0.2 Zeitungs 0.1
```

where a line contains the alternative edges (words and probs) between two consecutive nodes.

In the factored representation, each line gives alternatives over the full factor space:

```
Haus|N 0.1 aus|PREP 0.4 Aus|N 0.4 _eps_|_eps_ 0.1
der|DET 0.1 der|PREP 0.8 _eps_|_eps_ 0.1
Zeitung|N 0.7 _eps_|_eps_ 0.2 Zeitungs|N 0.1
```

Notice that if you project the above CN on a single factor, repetitions of factors must be merged and the respective probs summed up. The corresponding word-projected CN is the one of the first example, while the part-of-speech projected CN is:

```
N 0.5 PREP 0.4 _eps_ 0.1
DET 0.1 PREP 0.8 _eps_ 0.1
N 0.8 _eps_ 0.2
```

## 6.5 Word Lattices

A word lattice is a directed acyclic graph with a single start point and edges labeled with a word and weight. Unlike confusion networks which additionally impose the requirement that every path must pass through every node, word lattices can represent any finite set of strings (although this generality makes word lattices slightly less space-efficient than confusion networks). However, in general a word lattice can represent an exponential number of sentences in polynomial space. Here is an example lattice showing possible ways of decomposing some compound words in German:

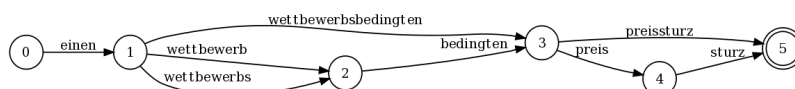

Moses can decode input represented as a word lattice, and, in most useful cases, do this far more efficiently than if each sentence encoded in the lattice were decoded serially. When Moses translates input encoded as a word lattice the translation it chooses maximizes the translation probability along *any* path in the input (but, to be clear, a single translation hypothesis in Moses corresponds to a single path through the input lattice).

### 6.5.1 How to represent lattice inputs

Lattices are encoded by ordering the nodes in a topological ordering (there may be more than one way to do this- in general, any one is as good as any other, but see the comments on `-max-phrase-length` below) and using this ordering to assign consecutive numerical IDs to the nodes. Then, proceeding in order through the nodes, each node lists its *outgoing* edges and any weights associated with them. For example, the above lattice can be written in the Moses format (also called the Python lattice format -- PLF):

```
(
(
('einen', 1.0, 1),
),
(
('wettbewerbsbedingten', 0.5, 2),
('wettbewerbs', 0.25, 1),
('wettbewerb', 0.25, 1),
),
(
('bedingten', 1.0, 1),
),
(
('preissturz', 0.5, 2),
('preis', 0.5, 1),
),
),
```

```
(
('sturz', 1.0, 1),
),
)
```

The second number is the probability associated with an edge. The third number is distance between the start and end nodes of the edge, defined as the numerical ID of the end node minus the numerical ID of the start node. Note that the nodes must be numbered in topological order for the distance calculation.

Typically, one writes lattices this with no spaces, on a single line as follows:

```
((('einen', 1.0, 1),), ((('wettbewerbsbedingten', 0.5, 2), ('wettbewerbs', 0.25, 1), \
('wettbewerb', 0.25, 1),), ((('bedingten', 1.0, 1),), ((('preissturz', 0.5, 2), \
('preis', 0.5, 1),), ((('sturz', 1.0, 1),),),)
```

### 6.5.2 Configuring mooses to translate lattices

To indicate that mooses will be reading lattices in PLF format, you need to specify `-inputtype 2` on the command line or in the `mooses.ini` configuration file. Additionally, it is necessary to specify the feature weight that will be used to incorporate arc probability (may not necessarily be a probability!) into the translation model. To do this, add `-weight-i X` where `X` is any real number.

In word lattices, the phrase length limit imposed by the `-max-phrase-length` parameter (default: 20) limits the difference between the indices of the start and the end node of a phrase. If your lattice contains long jumps, you may need to increase `-max-phrase-length` and/or renumber the nodes to make the jumps smaller.

### 6.5.3 Verifying PLF files with `checkplf`

The command `mooses-cmd/src/checkplf` reads a PLF (lattice format) input file and verifies the format as well as producing statistics.

Here's an example running the application on buggy input:

```
./checkplf < tanaka.plf
Reading PLF from STDIN...
Line 1: edge goes beyond goal node at column position 8, edge label = '&#65332;&#65313;&#65326;&#65313;&#65323;&#65313;'
Goal node expected at position 12, but edge references a node at position 13
```

Here's an example running the application on good input:



```
christopher-dyers-macbook:src redpony$ ./checkplf < ok.plf
Reading PLF from STDIN...
PLF format appears to be correct.
STATISTICS:
Number of lattices: 1
Total number of nodes: 7
Total number of edges: 9
Average density: 1.28571 edges/node
Total number of paths: 4
Average number of paths: 4
```

#### 6.5.4 Citation

If you use Moses's lattice translation in your research, please cite the following paper:

Chris Dyer, Smaranda Muresan, and Philip Resnik. Generalizing Word Lattice Translation<sup>7</sup>. In *Proceedings of the Annual Meeting of the Association for Computational Linguistics (ACL)*, July 2008.

*Subsection last modified on March 08, 2013, at 04:39 PM*

## 6.6 Publications

If you use Moses for your research, please cite the following paper in you publications:

- Philipp Koehn, Hieu Hoang, Alexandra Birch, Chris Callison-Burch, Marcello Federico, Nicola Bertoldi, Brooke Cowan, Wade Shen, Christine Moran, Richard Zens, Chris Dyer, Ondrej Bojar, Alexandra Constantin, Evan Herbst, **Moses: Open Source Toolkit for Statistical Machine Translation**, Annual Meeting of the Association for Computational Linguistics (ACL), demonstration session, Prague, Czech Republic, June 2007.

You can find out more on how Moses works from the following papers:

- Philipp Koehn and Hieu Hoang. **Factored Translation Models**, Conference on Empirical Methods in Natural Language Processing (EMNLP), Prague, Czech Republic, June 2007.
- Richard Zens and Hermann Ney. **Efficient Phrase-table Representation for Machine Translation with Applications to Online MT and Speech Translation**, Proceedings of the Human Language Technology Conference of the North American Chapter of the Association for Computational Linguistics (HLT-NAACL), Rochester, NY, April 2007.
- Nicola Bertoldi, Richard Zens, Marcello Federico and Wade Shen, **Efficient Speech Translation through Confusion Network Decoding**, IEEE Transactions on Audio, Speech, and Language Processing, vol. 16, no. 9, pp. 1696-1705, 2008
- Philipp Koehn **An Experimental Management System**, Proceedings of the Machine Translation Marathon 2010, The Prague Bulletin of Mathematical Linguistics, vol. 94, pp. 86-96, 2010.

<sup>7</sup><http://aclweb.org/anthology-new/P/P08/P08-1115.pdf>

- Kenneth Heafield: **KenLM: Faster and Smaller Language Model Queries**, Proceedings of the Sixth Workshop on Statistical Machine Translation (WMT), 2011.
- Marcin Junczys-Dowmunt: **Phrasal Rank-Encoding: Exploiting Phrase Redundancy and Translational Relations for Phrase Table Compression**, Proceedings of the Machine Translation Marathon 2012, The Prague Bulletin of Mathematical Linguistics, vol. 98, pp. 63-74, 2012.
- Nadir Durrani, Alexander Fraser, Helmut Schmid, Hieu Hoang, Philipp Koehn. **Can Markov Models Over Minimal Translation Units Help Phrase-Based SMT?**, Proceedings of the 51st Annual Conference of the Association for Computational Linguistics (ACL), Sofia, Bulgaria, August.
- Nadir Durrani, Hassan Sajjad, Hieu Hoang, Philipp Koehn. **Integrating an Unsupervised Transliteration Model into Statistical Machine Translation**, Proceedings of the 14th Conference of the European Chapter of the Association for Computational Linguistics (EACL), Gothenburg, Sweden, April 2014

*Subsection last modified on August 12, 2014, at 12:05 PM*

# 7

## Code Guide

### 7.1 Code Guide

#### 7.1.1 Github, branching, and merging

If you want to code with Moses, you should create your own repository in one of a number of ways.

The preference is that you fork the repository if you're doing long-term research. If you fixed a bug, please commit it yourself, or create a pull request.

- **Clone the moses github repository** to your hard disk and work with it:

```
git clone https://github.com/moses-smt/mosesdecoder.git mymoses
cd mymoses
edit files ....
git commit -am "Check in"
```

You don't need a github login or permission to do this. All changes are stored on your own hard disk

- **Clone AND branch the repository:**

```
git clone https://github.com/moses-smt/mosesdecoder.git mymoses
cd mymoses
git checkout -b mybranch
edit files ....
git commit -am "Check in"
```

You still don't need a github login or permission to do this.

- **Clone and branch AND push to github:**

```
git clone https://github.com/moses-smt/mosesdecoder.git mymoses
cd mymoses
git checkout -b mybranch
edit files ....
git commit -am "Check in"
git push origin mybranch
edit files ....
git commit -am "Check in again"
git push
```

You need a github account. And you have to ask one of the Moses administrators to add you as a committer to the Moses repository.

NB. To delete a LOCAL branch:

```
git branch -D new-branch
```

To delete a branch on the github server:

```
git push origin --delete new-branch
```

- **Fork the repository.** You need a github account. You don't need permission from the Moses administrators. Log into github.com on their website, and go to the Moses page:

```
https://github.com/moses-smt/mosesdecoder
```

Press the **Fork** button. This creates a new repository only you have write access to. Clone that repository and do whatever you want. Eg.

```
git clone https://github.com/hieuhoang/mosesdecoder.git
cd hieuhoang
edit files ....
git commit -am "Check in again"
git push
```

- **Clone and check into master**

```
git clone https://github.com/moses-smt/mosesdecoder.git mymoses
cd mymoses
edit files ....
git commit -am "Check in"
git push
```

You need a github account and write permission to the Moses repository.

- **Create pull request.** Fork a repository and read the instructions here:

```
https://help.github.com/articles/using-pull-requests
```

### Working with multiple branches

Assuming you've done **Fork the repository**, you can merge the latest changes from the main Moses repository with this command:

```
git pull https://github.com/moses-smt/mosesdecoder.git
```

In your own repository, you can create branches and switch between them using

```
git checkout -b new-branch
edit files...
git commit -am "check in"

git checkout master
edit files...
...
```

To get the latest changes from the main Moses repository to your branch, on your fork:

```
git checkout master
git pull https://github.com/moses-smt/mosesdecoder.git
git checkout new-branch
git merge master
```

## Regression test

If you've changed any of the C++ code and intend to check into the main Moses repository, please run the **regression test** to make sure you haven't broken anything:

```
git submodule init
git submodule update
./bjam with-irstlm=... --with-srilm=... {\bf -a --with-regtest} >& reg.out &
```

Check the output for any failures:

```
grep FAIL reg.out
```

## Contact the administrators

Contact Hieu Hoang or Barry Haddow, or any of the other administrators you might know, if you need help or permission to the github repository.

### 7.1.2 The code

This section gives an overview of the code. All the source code is commented for Doxygen, so you can browse a current snapshot of the source documentation<sup>1</sup>. Moses is implemented using object-oriented principles, and you can get a good idea of its class organization from this documentation

The source code is in the following directories

- `moses/util` contains some shared utilities, such as code for reading and parsing files, and for hash tables. This was originally part of KenLM.
- `moses/lm` contains KenLM, Moses default language model.
- `moses/src` contains the code for the decoder
- `moses/src/LM` contains the language model wrappers used by the decoder
- Other subdirectories of `moses/src` contain some more specialised parts of the decoder, such as alternative chart decoding algorithms.
- `moses-cmd/src` contains code relevant to the command line version of the phrase-based decoder
- `moses-cmd/src` contains code relevant to the command line version of the chart-based decoder
- `mert` contains the code for the Moses mert implementation, originally described here<sup>2</sup>

In the following, we provide a short walk-through of the decoder.

<sup>1</sup><http://www.statmt.org/moses/html/hierarchy.html>

<sup>2</sup><http://homepages.inf.ed.ac.uk/bhaddow/prague-mert.pdf>

### 7.1.3 Quick Start

- The main function: `moses-cmd/src/Main.cpp`
- Initialize the decoder
  - `moses/src/Parameter.cpp` specifies parameters
  - `moses/src/StaticData.cpp` contains globals, loads tables
- Process a sentence
  - `Manager.cpp` implements the decoding algorithm
  - `TranslationOptionCollection.cpp` contains translation options
  - `Hypothesis.cpp` represents partial translation
  - `HypothesisStack.cpp` contain viable hypotheses, implements pruning
- Output results: `moses-cmd/src/Main.cpp`
  - `moses-cmd/src/Iostream::OutputBestHypo` print best translation
  - n-best lists generated in `Manager.cpp`, output in `Iostream.cpp`

### 7.1.4 Detailed Guides

- Style Guide (Section 7.2)
- Background on factor, word, and phrase data structure (Section 7.3)
- Chart decoder (Section 7.4)
- Multithreading (Section 7.5)
- Adding feature functions (Section 7.6)

*Subsection last modified on July 28, 2013, at 08:33 AM*

## 7.2 Coding Style

To ensure maintainability and consistency, please follow the recommendations below when developing Moses.

### 7.2.1 Formatting

**Indentations** are 2 spaces. No tab characters allowed in the code. To ensure that your code follows this format run `scripts/other/beautify.perl` in the directory of the source code.

**Opening braces** are on a separate line, for instance:

```
if (expr) {  
  ...  
}
```

However, there is one special case, namely functions: they have the opening brace at the beginning of the next line, thus:

```
int Function(int x)
{
  body of function
}
```

**Upper/lowercase:** Start all functions and class names with capital letters. Start all variable with small letter. Start all class variable with `m_`. For instance:

```
void CalcNBest(size_t count, LatticePathList &ret) const;
Sentence m_source;
```

Use **long variable names**, not variables called `s`, `q`, or `qb`<sup>7</sup>.

**Do not use Hungarian notation**<sup>3</sup>.

## 7.2.2 Comments

The code will be parsed by Doxygen to create online documentation<sup>4</sup>. To support this, you have to add comments for each class, function, and class variable. More information is available at the Doxygen<sup>5</sup> web site.

**Class** definitions in the `*.h` file need to be preceded by a block starting with `/**`, for instance:

```
/** The Manager class implements a stack decoding algorithm.
 * Hypotheses are organized in stacks. One stack contains all hypothesis that have
 * the same number of foreign words translated. The data structure for hypothesis
 * stacks is the class HypothesisStack. The data structure for a hypothesis
 * is the class Hypothesis.
 [...]
 **/
class Manager
```

**Class member variable** definitions in `*.h` must be followed by a comment that starts with `/*!`, for instance:

<sup>3</sup>[http://en.wikipedia.org/wiki/Hungarian\\_notation](http://en.wikipedia.org/wiki/Hungarian_notation)

<sup>4</sup><http://www.statmt.org/moses/html/hierarchy.html>

<sup>5</sup><http://www.stack.nl/~dimitri/doxygen/docblocks.html>



```
size_t m_maxNumFactors;  //!< max number of factors on both source and target sides
```

**Functions** in the \*.cpp file need to be preceded by a block starting with /\*\*, for instance:

```
/**
 * Main decoder loop that translates a sentence by expanding
 * hypotheses stack by stack, until the end of the sentence.
 */
void Manager::ProcessSentence()
```

Function parameters are described by param, for instance:

```
/** Create translation options that exactly cover a specific input span.
 * Called by CreateTranslationOptions() and ProcessUnknownWord()
 * \param decodeGraph list of decoding steps
 * \param factorCollection input sentence with all factors
 * \param startPos first position in input sentence
 * \param lastPos last position in input sentence
 * \param adhereTableLimit whether phrase & generation table limits are adhered to
 */
void TranslationOptionCollection::CreateTranslationOptionsForRange(
const DecodeGraph &decodeGraph
, size_t startPos
, size_t endPos
, bool adhereTableLimit)
{
```

In addition the definition in the \*.h must be preceded by a short comment that starts with //!<. This comment will be displayed in the beginning of the class definition. For instance:

```
//! load all language models as specified in ini file
bool LoadLanguageModels();
```

### 7.2.3 Data types and methods

- Code for cross-platform compatibility.

- Use object-orientated designs, including
  - Create Get/Set functions rather than exposing class variables.
  - Label functions, variables and arguments as const where possible.
  - Prefer references over pointers
  - General styles
  - Prefer enum types over integers
  - Resolve compiler warnings as well as errors
  - Delete tracing/debugging code once they are not needed.

### 7.2.4 Source Control Etiquette

- Do not check in non-compilable code, or if functionality is reduced
- Ignore the above if you need to, just let people know
- Check-in your work often to avoid resolution conflicts
- Add log messages to check-ins
- Check in make/project files. However, you are not required to update project files other than the ones you use.

*Subsection last modified on May 26, 2015, at 06:41 PM*

## 7.3 Factors, Words, Phrases

Moses is the implemented of a factored translation model. This means that each word is represented by a vector of factors, which are typically word, part-of-speech tags, etc. It also means that the implementation is a bit more complicated than a non-factored translation model.

This section intends to provide some documentation of how factors, words, and phrases are implemented in Moses.

### 7.3.1 Factors

The class `Factor`<sup>6</sup> implements the most basic unit of representing text in Moses. In essence it is a string.

Factors do not know about their own type (which component in the word vector they represent), this is referred to as its `FactorType` when needed. This factor type is implemented as a `size_t`, i.e. an integer. What a factor really represents (be it a surface form or a part of speech tag), does not concern the decoder at all. All the decoder knows is that there are a number of factors that are referred to by their factor type, i.e. an integer index.

Since we do not want to store the same strings over and over again, the class `FactorCollection`<sup>7</sup> contains all known factors. The class has one global instance, and it provides the essential functions to check if a newly constructed factor already exists and to add a factor. This enables the comparison of factors by the cheaper comparison of the pointers to factors. Think of the `FactorCollection` as the global factor dictionary.

<sup>6</sup>[http://www.statmt.org/moses/html/classMoses\\_1\\_1Factor.html](http://www.statmt.org/moses/html/classMoses_1_1Factor.html)

<sup>7</sup>[http://www.statmt.org/moses/html/d2/d9f/classMoses\\_1\\_1FactorCollection.html](http://www.statmt.org/moses/html/d2/d9f/classMoses_1_1FactorCollection.html)

### 7.3.2 Words

A word is, as we said, a vector of factors. The class `Word`<sup>8</sup> implements this. As data structure, it is an array over pointers to factors. This does require the code to know what the array size is, which is set by the global `MAX_NUM_FACTORS`. The word class implements a number of functions for comparing and copying words, and the addressing of individual factors.

Again, a word does not know, how many factors it really has. So, for instance, when you want to print out a word with all its factors, you need to provide also the factor types that are valid within the word. See the function `Word::GetString` for details.

### 7.3.3 Factor Types

This is a good place to note that referring to words gets a bit more complicated. If more than one factor is used, it does not mean that all the words in the models have all the factors. Take again the example of a two-factored representation of words as surface form and part-of-speech. We may still use a simple surface word language model, so for that language model, a word only has one factor.

We expect the input to the decoder to have all factors specified and during decoding the output will have all factors of all words set. The process may not be a straight-forward mapping of the input word to the output word, but it may be decomposed into several mapping steps that either translate input factors into output factors, or generate additional output factors from existing output factors.

At this point, keep on mind that a `Factor` has a `FactorType` and a `Word` has a `vector<FactorType>`, but these are not internally stored with the `Factor` and the `Word`.

Related to factor types is the class `FactorMask`<sup>9</sup>, which is a bit array indicating which factors are valid for a particular word.

### 7.3.4 Phrases

Since decoding proceeds in the translation of input phrases to output phrases, a lot of operation involve the class `Phrase`<sup>10</sup>. Since the total number of input and output factors is known to the decoder (it has to be specified in the configuration file `moses.ini`), phrases are also a bit smarter about copying and comparing.

The `Phrase` class implements many useful functions, and two other classes are derived from it:

- The simplest form of input, a sentence as string of words, is implemented in the class `Sentence`<sup>11</sup>.
- The class `TargetPhrase`<sup>12</sup> may be somewhat misleadingly named, since it not only contains a output phrase, but also a phrase translation score, future cost estimate, pointer to source phrase, and potentially word alignment information.

*Subsection last modified on April 26, 2012, at 09:34 PM*

---

<sup>8</sup>[http://www.statmt.org/moses/html/d7/dc4/classMoses\\_1\\_1Word.html](http://www.statmt.org/moses/html/d7/dc4/classMoses_1_1Word.html)

<sup>9</sup>[http://www.statmt.org/moses/html/db/d41/classMoses\\_1\\_1FactorMask.html](http://www.statmt.org/moses/html/db/d41/classMoses_1_1FactorMask.html)

<sup>10</sup>[http://www.statmt.org/moses/html/df/d4d/classMoses\\_1\\_1Phrase.html](http://www.statmt.org/moses/html/df/d4d/classMoses_1_1Phrase.html)

<sup>11</sup>[http://www.statmt.org/moses/html/d3/dfd/classMoses\\_1\\_1Sentence.html](http://www.statmt.org/moses/html/d3/dfd/classMoses_1_1Sentence.html)

<sup>12</sup>[http://www.statmt.org/moses/html/db/d67/classMoses\\_1\\_1TargetPhrase.html](http://www.statmt.org/moses/html/db/d67/classMoses_1_1TargetPhrase.html)

## 7.4 Tree-Based Model Decoding

The chart decoder is a recursive variant of CKY+ parse/decoding which is able to process arbitrary context free grammars with no limitations on the number of terminals or non-terminals in a rule. During decoding, all contiguous spans over the input spans are filled with hypotheses (partial translations). Rules are stored in a prefix tree, which is processed incrementally, in a way akin to Early parsing. Once rules are looked up, cube pruning is applied to pick off the most likely applicable rules and hypotheses from underlying spans.

### 7.4.1 Looping over the Spans

ChartManager::ProcessSentence<sup>13</sup>

The main loop of the decoding process fills up the stack bottom up: first looping of the width of the span, and then over the starting position of the span.

```
for (size_t width = 1; width <= size; ++width) {
  for (size_t startPos = 0; startPos <= size-width; ++startPos) {
```

For each span, first the applicable rules are created and then the rules are applied.

```
m_transOptColl.CreateTranslationOptionsForRange(startPos, endPos);
ChartCell &cell = m_hypoStackColl.Get(range);
cell.ProcessSentence(m_transOptColl.GetTranslationOptionList(range)
, m_hypoStackColl);
```

Processing a span concludes with pruning, cleaning, and sorting of the hypotheses that were placed into the span.

```
cell.PruneToSize();
cell.CleanupArcList();
cell.SortHypotheses();
```

<sup>13</sup>[http://www.statmt.org/moses/html/d9/dde/classMoses\\_1\\_1ChartManager.html](http://www.statmt.org/moses/html/d9/dde/classMoses_1_1ChartManager.html)

### Consulting Rule Tables

ChartTranslationOptionCollection::CreateTranslationOptionsForRange<sup>14</sup>

Get existing data (or pointer?) from global rule collection

```
ChartTranslationOptionList &chartRuleColl = GetTranslationOptionList(startPos, endPos);
```

Multiple rule tables may be consulted. In fact, in most setups there will be a main rule table and a rule table for glue rules. So, we need to consult each of them.

```
ChartRuleLookupManager &ruleLookupManager;
ruleLookupManager.GetChartRuleCollection(wordsRange, true, chartRuleColl);
```

### 7.4.2 Looking up Applicable Rules

ChartRuleLookupManager::GetChartRuleCollection<sup>15</sup>

There are multiple implementations of the rule table. At the time of this writing, there are two: one that is kept entirely in memory and a second one that keeps the data on disk. There is an obvious RAM/speed trade-off here: the in-memory rule table is faster, but for some models there may not be sufficient RAM. Both are implemented very similarly, however.

For a given span, there may be many rules that could apply. Each rule may consume input words directly or build on any number of hypotheses that were generated for sub-spans. There is a combinatorial explosion of sub-spans and input words that could be combined, if there is a rule in the rule table.

The implementation of rule lookup is inspired by Early parsing, which allows for incremental lookup. Consider the English-German rule:

```
PP/NP -> of the JJ_1 problem of NP_2 ; des ADJ_1 Problems NP-GEN_2
```

This is a good time to clarify some terminology:

- PP is the source side parent non-terminal
- NP is the target side parent non-terminal
- JJ and NP are the source side child non-terminals
- of, the, problem and of are the source side child terminals (or words)

<sup>14</sup>[http://www.statmt.org/moses/html/de/dae/classMoses\\_1\\_1ChartTranslationOptionCollection.html](http://www.statmt.org/moses/html/de/dae/classMoses_1_1ChartTranslationOptionCollection.html)

<sup>15</sup>[http://www.statmt.org/moses/html/dd/d62/classMoses\\_1\\_1ChartRuleLookupManager.html](http://www.statmt.org/moses/html/dd/d62/classMoses_1_1ChartRuleLookupManager.html)

- ADJ and NP-GEN are the target side child non-terminals
- des and Problems are the target side child terminals (or words)

Instead of *child*, the term *right hand side*, and correspondingly instead of *parent*, the term *left hand side* is often used.

To check if the rule matches, we have to see if there are indeed English words *of*, *the*, *problem*, and *of* in the input and the intervening spans have the label JJ and NP. In addition, the rule can only apply if we have hypotheses with the constituent labels ADJ and NP-GEN in the corresponding spans.

We store the rule in a prefix structure with the following nodes:

```
of -> the -> JJ/ADJ -> problem -> of -> NP/NP-GEN -> des ADJ_1 Problems NP-GEN_2
```

The key insight is the following: If there is such an applicable rule for the span under consideration, then a sub-span with the same start position matched part of this prefix path, namely:

```
of -> the -> JJ/ADJ -> problem -> of
```

If, by the time we build the prefix, we know all possible terminal or non-terminal extensions (such as NP/NP-GEN) that match the prefix and start at the end of the sub-span, we can recursively find all rule applications, visiting each prefix and sub-span exactly once. Note: It does not matter if there is a translation rule associated with the prefix path, all it matters that it matches the sub-span.

We traverse the chart in a depth-first right-to-left order to ensure that all chart cells starting at the end position of the sub-span under considerations have been processed before (and that we can immediately find all applicable extensions of the prefix, such as NP/NP-GEN).

The code in `ChartRuleLookupManagerMemory::GetChartRuleCollection`<sup>16</sup> implements the lookup that we just described. It is extensively commented, so that it should be understandable without further explanation.

From the outside, each time the function is called for a span, it updates its internal data structures for processed rules and returns applicable rules for the span (with their target side) as a `ChartTranslationOptionList`.

Let us take a closer look at the data structures used in rule lookup in the function `ChartRuleLookupManagerMemory`

### CoveredChartSpan

Recall that processed rules are lookup up using a prefix tree, for example:

<sup>16</sup>[http://www.statmt.org/moses/html/df/d0b/classMoses\\_1\\_1ChartRuleLookupManagerMemory.html](http://www.statmt.org/moses/html/df/d0b/classMoses_1_1ChartRuleLookupManagerMemory.html)

<sup>17</sup>[http://www.statmt.org/moses/html/df/d0b/classMoses\\_1\\_1ChartRuleLookupManagerMemory.html](http://www.statmt.org/moses/html/df/d0b/classMoses_1_1ChartRuleLookupManagerMemory.html)

```
of -> the -> JJ/ADJ -> problem -> of -> NP/NP-GEN -> des ADJ_1 Problems NP-GEN_2
```

To use the rule, we need to know how each of these nodes in this path matches the chart, in other words: how each node matches a span. This is encoded in a linked list of `CoveredChartSpans`.

Each `CoveredChartSpan` contains the start and end position in the span (store in a `WordsRange`, which is essential a pair of integers with additional utility functions), the source word or source span label that is matched (as a `Word`), and a back-pointer to the previous `CoveredChartSpan` (hence the linked list).

The linked list of `CoveredChartSpans` contains all the necessary information about applying the rule to the source side. Target side information is stored elsewhere. Note that target-side non-terminals are not stored anymore, since they will be contained in the target side information.

The core operations of the data structure are `GetSourceWord`, `GetWordsRange`, and `GetPrevCoveredChartSpan`. There is also the utility function `IsNonTerminal` which checks if the last word in the linked list is a non-terminal.

### **ChartTranslationOptionList and ChartTranslationOption**

A `ChartTranslationOptionList` is a vector of `ChartTranslationOptions`, with additional utility functions.

Rules are added to this in batches, since rules are stored in the prefix tree first by matching the source words and child non-terminals, pointing towards a list of target sides.

The list contains fully fledged out rules with target sides (opposed to the cube pruning algorithm described by Chiang, where rules are groups modulo the target side words). The list also observes rule limits, i.e., the maximum number of rules considered for a span. It sorts the rules by the future score of the target side (weighted translation model costs and language model estimates), and prunes out the worst ones when the limit is exceeded. Internally a score threshold is kept, to not even add rules that would be pruned out anyway.

Note that when adding `ChartTranslationOption` ultimately some additional processing has to be done — the computation of the alignment between non-terminals by calling `ChartTranslationOption::Create`. This is done lazily, once the list finalized and pruned.

### **ChartTranslationOption**

A `ChartTranslationOption` contains all the information about a rule and its application to the span. It contains a linked list of `CoveredChartSpan` which details how the rule matches the input side, a `TargetPhrase` with the output, and the span it applies to (in a `WordsRange`).

This information has to be specified at instantiation and can be queried with the functions `GetLastCoveredChartSpan`, `GetTargetPhrase`, and `GetSourceWordsRange`.

Once created, the mapping between the source and target non-terminals is computed by calling `CreateNonTermIndex` and can be queried with `GetCoveredChartSpanTargetOrder`. That information is already stored with the `TargetPhrase`, but it is reformatted here for easier querying (at the cost of a higher memory footprint).

**PhraseDictionarySCFG**

This class implements the prefix tree that contains the rules.

**TargetPhraseCollection****PhraseDictionaryNodeSCFG****7.4.3 Applying the Rules: Cube Pruning**

Above, we described how all the rules that apply to the current span are retrieved. In fact, more than that is done: we also annotate each rule how it applies to the span, especially how the non-terminals match the sub-spans.

Applying a rule now only requires the selection of the hypotheses in the specified sub-spans that match the non-terminals in the rule.

To repeat our example:

```
PP/NP -> of the JJ_1 problem of NP_2 ; des ADJ_1 Problems NP-GEN_2
```

We have already identified which sub-spans the target non-terminals ADJ and NP-GEN apply to. For each of these, however, we may have multiple choices (note that there will be at least one for each, otherwise we would not consider the rule).

The term *cube* pruning derives from the fact that we explore for each rule a multi-dimensional space, with one dimension for each non-terminal (and, in the original Chiang algorithm, but not here, one dimension for the target phrase). This space is not always a cube, only if there are three dimensions (two non-terminals in the Chiang algorithm), and even then it is not a cube because the dimensions typically have differing lengths. And it is not technically a pruning algorithm (which removes bad examples after the fact), but a greedy search for the best rule applications. But hey, what's in a name?

Given the *cube*, we sort each dimension, so that the most promising rule application is in the top left front corner. Most promising, because for each of the non-terminals, we use the matching hypothesis with the best score (and the target phrase with the best future cost estimate).

Finally recall that there are multiple cubes, one for each applicable rule.

**ChartCell::ProcessSentence<sup>18</sup>**

The cube pruning algorithm is given two data structures, a `ChartTranslationOptionList` that contains all applicable rules (they are now called `ChartTranslationOption`) and the `ChartCellCollection` that contains the chart as it has been filled in so far. The cube pruning algorithm is housed in the `ChartCell` that corresponds to the span we are now filling.

<sup>18</sup>[http://www.statmt.org/moses/html/d0/dd7/classMoses\\_1\\_1ChartCell.html](http://www.statmt.org/moses/html/d0/dd7/classMoses_1_1ChartCell.html)



First, we have to build the `RuleCubeQueue`. Recall, how each applicable rule has a *cube*. Well, we throw them all together into one big cube (not really a regular geometrical shape, since the dimensions differ for each rule application). Be that as it may, the first part of the algorithm loops through the `ChartTranslationOptionList` and creates a `RuleCube` and adds it to the cube.

The `RuleCubeQueue` keeps the `RuleCubes` sorted, so that we can always pop off the most promising rule application with its most promising underlying sub-span hypotheses. For a specified number of times (`staticData.GetCubePruningPopLimit()`)

- we pop off the most promising `RuleCube` (by calling `ruleCubeQueue.Pop()`)
- build a new `ChartHypothesis` and calculate its score (`hypo->CalcScore()`)
- add the hypothesis to the `ChartCell`
- add add the neighbors of the hypothesis to the `RuleCubeQueue` (`ruleCube->CreateNeighbors(ruleCubeQueue)`)

### ChartCell

A chart cell contains the hypothesis that were created for a span. These hypothesis are grouped by their target side non-terminal.

### RuleCubeQueue

`RuleCubeQueue` is a priority queue of `RuleCubes` (candidate rule applications). Initially it contains the top-left-front rule application for each `ChartTranslationOption`. When these are expanded, their neighbors are added to the `RuleCubeQueue`.

Note that the same neighbor might be reached in multiple ways. If the rule applications  $(0,0,0)$ ,  $(1,0,0)$  and  $(0,1,0)$  are popped off, then the latter two point to  $(1,1,0)$ . This is checked in `RuleCubeQueue`, which does not allow insertion of duplicates.

### RuleCube

This class contains the *cube* for a rule. It contains information about the `ChartTranslationOption` and the a list of underlying sub-span hypotheses for each non-terminal in the rule. The latter is represented as a vector of `ChildEntry`s, which are essentially ordered lists of hypotheses with additional utility functions.

When the `RuleCube` is created from a `ChartTranslationOption`, the vector of `ChildEntry`s is assembled from the information in the chart. Also, the estimated score of the top-left-front rule application is computed and stored. Note that this is a estimated score, it does not have the real language model cost.

A `RuleCube` always points to a particular rule application (i.e., particular sub-span hypotheses) in the cube. If it is picked to create an hypothesis, then its neighbors are added to the `RuleCubeQueue` — this is implemented in the function `CreateNeighbors`. Consequently, for a particular `ChartTranslationOption`, there may be multiple `RuleCubes` in the `RuleCubeQueue`.

### 7.4.4 Hypotheses and Pruning

New hypotheses are build in the `ChartCell::ProcessSentence`<sup>19</sup> function from a `RuleCube`.

```
ChartHypothesis *hypo = new ChartHypothesis(*ruleCube, m_manager);
hypo->CalcScore();
AddHypothesis(hypo);
```

A `ChartHypothesis` contains various type of information about a entry in the chart, i.e., a translation of the covered span.

- Book-keeping
  - `size_t m_id` hypothesis ID
  - `Manager& m_manager` reference to manager
  - `WordsRange m_currSourceWordsRange` covered span
  - `ChartTranslationOption &m_transOpt` rule that created it
  - `vector<size_t> &m_coveredChartSpanTargetOrder` covered sub-spans
- Scores
  - `ScoreComponentCollection m_scoreBreakdown` all scores
  - `ScoreComponentCollection m_lmNGram` language model scores
  - `ScoreComponentCollection m_lmPrefix` estimated language model scores for prefix
  - `float m_totalScore` total weighted score
- Information relevant for recombination and later use
  - `Phrase m_contextPrefix` first words (not yet fully LM-scored)
  - `Phrase m_contextSuffix` last words (affect later attached words)
  - `size_t m_numTargetTerminals` length of phrase (number of words)
- Back-tracking
  - `ChartHypothesis *m_winningHypo` points to superior hypothesis if recombined away
  - `ArcList *m_arcList` all arcs that end at the same trellis point as this hypothesis
  - `vector<const ChartHypothesis*> m_prevHypos` underlying hypotheses

When a hypothesis is created, the *book-keeping* and *information relevant for recombination and later use* is set.

*Scores* are computed by the function `CalcScore`, by adding up the scores from the underlying hypothesis, the rule application, and language model scoring of the resulting phrase. Language model scoring (in function `CalcLMscore`) is a bit complex, since we do not want to re-compute any of the language model scores that we already computed for the underlying hypotheses. See the documented code for details.

Hypothesis recombination is handled by `ChartHypothesisCollection`. The function `Add` is called to check if the hypothesis is recombinable with anything already in the collection (the class `ChartHypothesisRecombinationOrderer` handles state matching and calls `ChartHypothesis::LMContext`. `AddHypothesis` calls `Add`, and handles the recombination by potentially replacing the existing hypothesis and setting arcs (`ChartHypothesis::AddArc`).

*Subsection last modified on September 29, 2014, at 11:29 AM*

<sup>19</sup>[http://www.statmt.org/moses/html/d0/dd7/classMoses\\_1\\_1ChartCell.html](http://www.statmt.org/moses/html/d0/dd7/classMoses_1_1ChartCell.html)

## 7.5 Multi-Threading

Modern server machines have multiple CPUs, each with multiple cores. Utilizing all these cores requires either running multiple processes on the same machine or writing programs that use multiple threads.

Since many aspects of a machine translation system (training, tuning, using) lend themselves very easily to parallel processing, Moses increasingly uses multi-threading in its components. At this point, the following components allow for parallel execution when the switch "--threads NUM" is added with an appropriate maximum number of threads executed at the same time:

- the decoder binary `moses`
- the minimum error rate training tuner `mert`
- the hierarchical rule extractor `extract-rules`

Multi-threading in Moses is based on the C++ Boost libraries, and two Moses helper libraries that make the type of multi-threading that is typical for Moses more convenient: `ThreadPool` and `OutputCollector`.

We will explain the implementation of multi-threaded processing on hand of a simple example.

### 7.5.1 Tasks

The part of the program that is to be run in parallel threads is called a **task**, and it needs to be placed into a class of its own.

```
class ExampleTask : public Moses::Task
{
public:
ExampleTask() {}
~ExampleTask() {}

void Run() {
std::cout << "Hello World." << endl;
}
}
```

Such a class now allows to be instantiated and run:

```
ExampleTask *task = new ExampleTask()
new->Run();
delete(new);
```

This will print "Hello World.", and is otherwise not very exciting.

Let's make the task a bit more interesting. Our new task waits for a random amount of time and then prints out a message:

```
ExampleTask(string message):m_message(message) {}

void Run() {
// length of pause
int r = rand()%10;

// pause
int j = 0;
for(int i=0; i<1e8*r; i++) { j+=i; }

// write message (and length of pause)
std::cout << m_message << " (" << r << ")" << endl;
}
```

We can now create multiple instances of this task, and execute each:

```
// set up tasks
srand(time(NULL));
ExampleTask *task0 = new ExampleTask("zero");
ExampleTask *task1 = new ExampleTask("one");
ExampleTask *task2 = new ExampleTask("two");

// serial execution
task0->Run();
task1->Run();
task2->Run();
```

This will print out three lines (the random numbers in parenthesis will vary):

```
zero (2)
one (4)
two (5)
```

Okay, where is the multi-threading? Here it comes.

### 7.5.2 ThreadPool

Instead of simply running one of the tasks after the other, we assign them to a thread pool. Once assigned, they are spawned off to a thread and will be executed in parallel to the running main process.

```
// set up thread pool
int thread_count = 10;
Moses::ThreadPool pool(thread_count);

// submit tasks
pool.Submit(task0);
pool.Submit(task1);
pool.Submit(task2);

// wait for all threads to finish
pool.Stop(true);
```

That's all too easy to be true, right? Yes, it is.

Since the three threads are running in parallel, there is no telling when they print out their message. Not only could the lines be printed in a different order than the tasks were scheduled, the threads may even write all over each other.

This is the catch with multi-threading: any interaction with non-local data structures must be handled very carefully. Ideally, threads only change local data (defined in the class), and once they are done (after `pool.Stop(true)`), results can be read out. This is in fact what happens in multi-threaded `mert`<sup>20</sup>.

In our case, as in the decoder, we want to output text line by line (the decoder outputs translation, and possibly additional information such as n-best lists).

### 7.5.3 OutputCollector

The Moses code offers the class `OutputCollector` to buffer up the output until it is safe to print out. In the simplest case, it prints to `STDOUT`, but it can also write to a file, and indeed it offers both regular output (default `STDOUT`) and debugging output (default `STDERR`), which both can be redirected to different files.

```
Moses::OutputCollector* outputCollector = new Moses::OutputCollector();
```

A task can then send its output to the output collector with the function `Write`, for example:

---

<sup>20</sup>[http://www.statmt.org/moses/html/d6/d7d/mert\\_8cpp\\_source.html](http://www.statmt.org/moses/html/d6/d7d/mert_8cpp_source.html)

```
m_collector->Write(id, "Hello World!");
```

The `id` is the sequential number of the sentence, starting at 0. This helps the output collector to keep track of what can be written out and what needs to be buffered. The output collector will not write output for sentence 1, if it has not yet received output for sentence 0.

#### 7.5.4 Not Deleting Threads after Execution

By default, the `Task` objects are deleted after execution. However, you may want to keep the objects around. This happens for instance in `mert`, where each `Task` finds an optimized weight setting, which is to be processed afterwards. In this case, you have to add the following lines to your `Task` definition:

```
virtual bool DeleteAfterExecution() {
return false;
}
```

#### 7.5.5 Limit the Size of the Thread Queue

By default, when a thread is submitted to the `ThreadPool` by calling its `Submit()` function, it is added to an internal queue, and the main process immediately resumes. That means, if a million threads are scheduled, the thread queue is filled with a million instances of the `Task`, which may consume a lot of memory.

If you want to restrict the number of threads in the queue, you can call, say, `pool.SetQueueLimit(1000)` to limit it to 1000 queued `Task` instances. When the queue is full, `Submit()` blocks.

#### 7.5.6 Example

Below now the complete example.

Note:

- The task class has now two more class variables which are set upon instantiation: the sequence id `m_id` (a sequential number starting at 0), and a pointer to the output collector `m_collector`.
- Always implement a fallback to non-threaded compilation (`#ifdef WITH_THREADS .. #else .. #endif`)
- Output is placed into a file named `output-file.txt` (lines 43-45) instead of `STDOUT`.

```
01: #include <iostream>
02: #include <fstream>
03: #include <ostream>
04: #include <cstdlib>
05: #include <sstream>
06: #include "ThreadPool.h"
07: #include "OutputCollector.h"
08:
09: using namespace std;
10:
11: class ExampleTask : public Moses::Task
12: {
13: private:
14:     unsigned int m_id;
15:     string m_message;
16:     Moses::OutputCollector* m_collector;
17: public:
18:     ExampleTask(unsigned int id, string message, Moses::OutputCollector* collector):
19:         m_id(id),
20:         m_message(message),
21:         m_collector(collector) {}
22:
23:     ~ExampleTask() {}
24:
25:     void Run() {
26:         // length of pause
27:         int r = rand()%10;
28:
29:         // pause
30:         int j = 0;
31:         for(int i=0; i<1e8*r; i++) { j+=i; }
32:
33:         // write message (and length of pause)
34:         ostringstream out;
35:         out << m_message << " (" << r << ")" << endl;
36:         m_collector->Write(m_id, out.str());
37:     }
38: };
39:
40: int main ()
41: {
42:     // output into file
43:     string outfile = "output-file.txt";
44:     std::ofstream *outputStream = new ofstream(outfile.c_str());
45:     Moses::OutputCollector* outputCollector = new Moses::OutputCollector(outputStream);
46:
47:     // set up tasks
48:     srand(time(NULL));
49:     ExampleTask *task0 = new ExampleTask(0,"zero",outputCollector);
50:     ExampleTask *task1 = new ExampleTask(1,"one",outputCollector);
51:     ExampleTask *task2 = new ExampleTask(2,"two",outputCollector);
52:
53: #ifdef WITH_THREADS
54:     // set up thread pool
55:     int thread_count = 10;
56:     Moses::ThreadPool pool(thread_count);
57:
58:     // submit tasks
59:     pool.Submit(task0);
```

```

60: pool.Submit(task1);
61: pool.Submit(task2);
62:
63: // wait for all threads to finish
64: pool.Stop(true);
65: #else
66: // fallback: serial execution
67: task0->Run();
68: task1->Run();
69: task2->Run();
70: #endif
71: }

```

To compile this, you need to copy `ThreadPool.h`, `ThreadPool.cpp`, and `OutputCollector.h` into your code directory or add paths so that they point to the `moses/src` directory and compile as follows:

```

g++ -c ThreadPool.cpp -DWITH_THREADS -DBOOST_HAS_PTHREADS
g++ -c test.cpp -DWITH_THREADS -DBOOST_HAS_PTHREADS
g++ -o test test.o ThreadPool.o -pthread -lboost_thread-mt

```

Make sure that the Boost libraries are in your compile paths.

When you run this example you will notice that, whatever the lengths of the pauses, the output always appears in the correct order (i.e. zero, one, two).

*Subsection last modified on April 18, 2012, at 12:49 AM*

## 7.6 Adding Feature Functions

*History:*

*April 13th, 2012: Checked and revised for latest version (Barry Haddow)*

The log-linear model underlying statistical machine translation allows for the combination of several components that each weigh in on the quality of the translation. Each component is represented by one or more features, which are weighted, and multiplied together.

Formally, the probability of a translation  $\mathbf{e}$  of an input sentence  $\mathbf{f}$  is computed as

$$p(\mathbf{e}|\mathbf{f}) = \prod_i h_i(\mathbf{e}, \mathbf{f})^{\lambda_i} \quad (7.1)$$

where  $h_i$  are the feature functions and  $\lambda_i$  the corresponding weights.

Note that the decoder internally uses logs, so in fact what is computed is



$$\log p(\mathbf{e}|\mathbf{f}) = \sum_i \log(h_i(\mathbf{e}, \mathbf{f})) \lambda_i \quad (7.2)$$

The tuning (Section 5.14) stage of the decoder is used to set the weights.

The following components are typically used:

- phrase translation model (4 features, described here (Section 5.9))
- language model (1 feature)
- distance-based reordering model (1 feature)
- word penalty (1 feature)
- lexicalized reordering model (6 features, described here (Section 5.10))

One way to attempt to improve the performance of the system is to add additional feature functions. This section explains what needs to be done to add a feature. Unless otherwise specified the Moses code files are in the directory `moses/`. In the following we refer to the new feature as `xxx`.

Side note: Adding a new component may imply that several scores are added. In the following, as in the Moses source code, we refer to both components and scores as *features*. So, a feature may have multiple features. Sorry about the confusion.

### 7.6.1 Video

There is a 10 minute video demonstrating how to create your own feature function here<sup>21</sup>.

### 7.6.2 Other resources

Kenton Murray has a nice blog on how to add a new feature function to Moses  
<http://kentonmurray.com/blogs/addingafeaturetomoses.html>

### 7.6.3 Feature Function

The feature computes one or more values, and we need to write a **feature function** for it.

One important question about the new feature is, if it depends on just on the current phrase translation, or also on prior translation decision. We call the first case **stateless**, the second **stateful**. If the new feature is stateless, then it should inherit from the class `StatelessFeatureFunction`, otherwise it should inherit from `StatefulFeatureFunction`

The second case causes additional complications for the dynamic programming strategy of recombining hypotheses. If two hypotheses differ in their past translation decisions which matters for the new feature, then they cannot be recombined.

<sup>21</sup><http://www.youtube.com/watch?v=x-uo522bplw>

For instance, the word penalty does only depend on the current phrase translation and is hence stateless. The distortion features also depend on the previous phrase translation and they are hence stateful. You can see the implementation of `WordPenaltyProducer` and `DistortionScoreProducer` in the directory `moses/FF`.

However, new features are usually more complicated. For instance, it requires reading in a file and representing it with a data structure and more complex computations. See `moses/LM/SRI.h` and `moses/LM/SRI.cpp` for something more involved.

In the following, we assume such a more complex feature, which is implemented in its own source files `XXX.h` and `XXX.cpp`. The feature is implemented as a class which inherits from either `StatefulFeatureFunction` or `StatelessFeatureFunction`. So, you will write some code in `XXX.h` that starts with

```
namespace Moses
{
class XXX : public StatefulFeatureFunction {
...
}
```

The class must contain the constructor:

```
XXX::XXX(const std::string &line)
: StatefulFeatureFunction(line)
{
....
}
```

The constructor must call the

```
StatelessFeatureFunction(...) or
StatefulFeatureFunction(...) or
```

or something that eventually calls one of this functions.

The constructor must also call the method

```
ReadParameters()
```

This is inherited from class `FeatureFunction`, it should NOT be overridden.

The *line* is the complete line from the ini file that instantiate this feature, eg.

```
KENLM factor=0 order=5 num-features=1 lazyken=1 path=path/file
```

The class must also contain the function:

```
bool IsUseable(const FactorMask &mask) const;
```

This function returns true if, given a target phrase only factors in mask, the feature can be evaluated. If the feature doesn't need to look at words in the target phrase, always return true. Return true if you don't use factors.

A good example of `IsUseable()` is in

```
moses/LM/SingleFactor.cpp
```

This is the only necessary method the class HAS to implement. All other methods are optional.

An important function to override is

```
void Load(AllOptions::ptr const& opts)
```

Override this function if the feature needs to load files. For example, language model classes load their LM files here. The first thing this function should do is save a pointer to the current set of options that is passed as the parameter:

```
void Load(AllOptions::ptr const& opts) {  
m_options = opts;  
...  
}
```

Many feature function needs parameters to be passed in from the ini file. For example,

```
KENLM factor=0 order=5 num-features=1 lazyken=1 path=path/file
```

has the parameters *factor*, *order*, *num-features*, *lazyken*, *path*. To read in these parameters, override the method

```
void FeatureFunction::SetParameter(const std::string& key, const std::string& value)
```

This method **MUST** call the same method in it's parent class if the parameter is unknown, eg.

```
if (key == "input-factor") {
m_factorTypeSource = Scan<FactorType>(value);
} else {
StatelessFeatureFunction::SetParameter(key, value);
}
```

The feature function needs to be registered in `Factory.cpp`, `FeatureRegistry()`:

```
#include "XXX.h"
...
MOSES_FNAME(XXX);
```

#### 7.6.4 Stateless Feature Function

The above is all that is required to a feature function. However, it doesn't do anything yet.

If the feature is stateless, it should override one of these methods from the class `@FeatureFunction@@`:

```
1. virtual void EvaluateInIsolation(const Phrase &source
, const TargetPhrase &targetPhrase
, ScoreComponentCollection &scoreBreakdown) const
2. virtual void EvaluateWithSourceContext(const InputType &input
, const InputPath &inputPath
, const TargetPhrase &targetPhrase
, const StackVec *stackVec
, ScoreComponentCollection &scoreBreakdown
, ScoreComponentCollection *estimatedFutureScore) const
```

Or it can override one of these methods, specific to the `StatelessFeatureFunction` class.

```
3. virtual void EvaluateWhenApplied(const Hypothesis& hypo,
ScoreComponentCollection* accumulator) const
4. virtual void EvaluateWhenApplied(const ChartHypothesis &hypo,
ScoreComponentCollection* accumulator) const
```

Usually, method (1) should be overridden. See `WordPenaltyProducer.cpp` for a simple example using (1).

*Note* - Only scores evaluated in (1) is included in future cost estimation in phrase-based model

Some stateless feature functions needs to know the entire input sentence to evaluate, for example. a bag of word feature. In this case, use method (2).

Use method (3) or (4) if the feature function requires the segmentation of the source, or any other information available from the context. *Note* - these methods are identical to the those used by stateful features, except that they don't return state.

Each stateless feature function can override 1 or more of the above methods. So far (June, 2013) all stateless feature override only 1 method.

The methods are called at different stages in the decoding process.

- (1) is called before the search process, when the translation rule is created. This could be when the phrase-table is loaded (in the case of memory-based phrase-table), or just before the search begin for binary phrase tables.
- (2) is called just before the search begins.
- (3) and (4) are called during search when hypotheses are created.

### 7.6.5 Stateful Feature Function

Stateful feature functions should inherit from class `StatefulFeatureFunction`. There are 2 class methods that can be overridden by the feature functions to score hypotheses:

```
5. virtual FFState* EvaluateWhenApplied(
const Hypothesis& cur_hypo,
const FFState* prev_state,
ScoreComponentCollection* accumulator) const = 0;

6. virtual FFState* EvaluateWhenApplied(
const ChartHypothesis& /* cur_hypo */,
int /* featureID - used to index the state in the previous hypotheses */,
ScoreComponentCollection* accumulator) const = 0;
```

As the names suggest, (5) is used to score a hypothesis from a phrase-based model. (6) is used to score 1 from the hierarchical/syntax model.

In addition, a stateful feature function can also override methods (1) and (2) from the base `FeatureFunction` class.

For example, language models are stateful. All language model implementation should override (5) and (6). However, they should also override (1) to score the translation rule in isolation. See classes `LanguageModelImplementation` and `LanguageModel` for the implementation of scoring language models.

Stateful feature function must also implement

```
const FFState* EmptyHypothesisState() const
```

### 7.6.6 Place-holder features

Some features don't implement any `Evaluate()` functions. Their evaluation is more interwoven with the creation of the translation rule, the feature function is just used as a placeholder where the scores should be added.

Phrase-table (class `PhraseDictionary`), generation model (class `GenerationDictionary`), unknown word feature (class `UnknownWordPenaltyProducer`), and input scores for confusion networks and lattices (class `InputFeature`).

### 7.6.7 moses.ini

All feature functions are specified in the `[feature]` section. It should be in the format:

```
* Feature-name key1=value1 key2=value2 ....
```

For example,

```
KENLM factor=0 order=3 num-features=1 lazyken=0 path=file.lm.gz
```

Keys must be unique. There must be a key

```
* num-features=??
```

which specifies the number of dense scores for this feature.

The key

```
* name=??
```

is optional. If it is specified, the feature name must be unique. If it is not specified, then a name is automatically created. All other key/value pairs are up to the feature function implementation.

### 7.6.8 Examples

The struck-out examples are formatted in the old Moses v.1, and before. The clear examples are for current Moses in github.

NB. moses.ini files in the old format can still be read by the new decoder, if they just contain the common, vanilla features (ie. no sparse features, suffix arrays, or new features that have recently been added).

NB. 2 - Do NOT mix the old and new format in 1 ini file.

#### Phrase-tables

##### In-memory phrase-table (phrase-based):

```
PhraseDictionaryMemory num-features=5 path=phrase-table.gz input-factor=0 output-factor=0 table-limit=20
```

Note - The old method is relaxed about whether you add '.gz' to the file name; it will try it with and without and see what exists. The new method is strict - you MUST specify '.gz' if the file ends with .gz, otherwise you must NOT specify '.gz'

##### Binary phrase-table (phrase-based):

```
PhraseDictionaryBinary num-features=5 path=phrase-table.gz input-factor=0 output-factor=0
```

Note - the binary phrase table consist of 5 files with the following suffixes:

```
binphr.idx  
binphr.srcvoc  
binphr.tgtvoc
```

and (without word alignment):

```
binphr.srctree  
binphr.tgtdata
```

or (WITH word alignment)

```
binphr.srctree.wa  
binphr.tgtdata.wa
```

The path value must point to the PREFIX of the files. For example, if the files are called:

```
folder/pt.binphr.idx, folder/pt.binphr.srcvoc, folder/pt.binphr.tgtvoc ....
```

then

```
path=folder/pt
```

**In-memory phrase-table (hierarchical/syntax):**

```
PhraseDictionaryMemory num-features=5 path=phrase-table.gz input-factor=0 output-factor=0 table-limit=20
```

See "In-memory phrase-table (phrase-based) for notes.

**On-disk phrase-table (hierarchical/syntax):**



```
PhraseDictionaryOnDisk num-features=5 path=phrase-table.gz input-factor=0 output-factor=0 table-limit=20
```

Note - the on-disk phrase-table consists of 5 files:

```
Misc.dat  
Source.dat  
TargetColl.dat  
TargetInd.dat  
Vocab.dat
```

The path value must point to the FOLDER in which these files are found.

### Language models

#### SRILM:

```
SRILM factor=0 order=5 path=lm.gz
```

#### IRSTLM:

```
IRSTLM factor=0 order=5 path=lm.gz
```

#### KenLM:

```
KENLM factor=0 order=5 path=lm.gz
```

#### Lazy KenLM:

```
KENLM factor=0 order=5 path=lm.gz lazy=1
```

## Reordering models

```
LexicalReordering num-features=6 type=msd-bidirectional-fe input-factor=0 output-factor=0 path=reordering-table.msd-bidirectional-fe.0.5.0-0.gz
```

### Misc features

New mose must have Distortion, WordPenalty, and UnknownWordPenalty explicitly in the list of feature functions. They require no arguments, ie.

```
[feature]
UnknownWordPenalty
WordPenalty
Distortion
```

In the old moses, they were implicitly added by the decoder.

### Sparse features

There are lots of ad-hoc features are currently implemented. You must look at the code and ask the developer to see how to run them

*Subsection last modified on January 05, 2016, at 08:14 AM*

## 7.7 Adding Sparse Feature Functions

Moses allows for sparse feature functions, i.e., feature functions that have a large, maybe unbounded, set of features, of which only a small subset applies to a given hypothesis.

**ALL** feature functions can contain sparse features. They don't have to specify if or how many sparse features they will have. Contrast this with dense features, where feature function must specify how many scores they have at construction time.

To give an example: In addition to a regular n-gram language model, we could introduce a discriminative bigram language model that discounts or promotes hypotheses that contain specific bigrams. Each bigram in this feature function is its own feature with its own feature weight.

These features cannot be tuned with MERT, but Moses has several other suitable tuning (Section 5.14) methods.

The incorporation of sparse features into the training pipeline<sup>22</sup> is ongoing.

<sup>22</sup><http://www.statmt.org/moses/?n=Moses.SparseFeatureTraining>

### 7.7.1 Implementation

For basics, please refer to the respective section on Feature Functions (Section 7.6).

#### Header

```
class PhraseLengthFeature : public StatelessFeatureFunction {
public:
PhraseLengthFeature(const string &line):
StatelessFeatureFunction(0, line)
{}
```

This creates a feature function `PhraseLengthFeature` with no dense features, but it can have sparse features.

#### Setting feature values

As with all feature functions, sparse feature functions should implement the appropriate `Evaluate()` methods described in `FeatureFunctions` (Section 7.6).

In the `Evaluate()` methods, a particular sparse score can be set using by calling the function

```
accumulator->PlusEquals(this, <name>, <value>);
```

where `<name>` is a key (a string) of the sparse feature.

Contrast this with setting a dense score:

```
accumulator->PlusEquals(this, <vector-of-values>);
```

### 7.7.2 Weights

There is no need to define a switch `[weight]` for the feature function. Each feature of the feature function has its own named weight, which is a concatenation of the short name of the feature function, and underscore (`_`) and its individual name for which the feature function sets.

These weights are placed into a weight file which is specified with the switch `--weight-file`. For example, the target bigram feature weights (feature function short name `dlmb` for discriminative language model, bigrams) may have weights defined in lines such this:

```
dlmb_of:the 0.1
dlmb_in:the -0.1
dlmb_the:way 0.2
```

Features that do not have weights that are defined in this file are set to 0.

*Subsection last modified on December 06, 2013, at 03:15 PM*

## 7.8 Regression Testing

### 7.8.1 Goals

The goal of regression testing is to ensure that any changes made to the decoder do not break what has been determined to be correct, previously. The regression test suite is fast enough to run often, but still should provide adequate confidence that nothing substantial has changed about the internal workings of moses. The regression test suite is designed to run on most UNIX-like systems. The regression test suite is run as part of the nightly build<sup>23</sup>, so if you have problems with the regression tests you should first check if the nightly build succeeded.

### 7.8.2 Test suite

The following regression tests are currently implemented (and **many** more have been added since this list was written):

- `basic-surface-only` Tests basic translation, compares output strings and probability scores.
- `basic-surface-binptable` Tests binary phrase table
- `consensus-decoding-surface` Basic test of consensus decoding
- `ptable-filtering` Tests the filtering of the phrase table by estimated phrase cost, ensures that the estimated phrase cost stays the same and that the same list of phrases is consistent. Matches pharaoh.
- `multi-factor` Test that moses can do translation with two factors (Currently does a very basic test- it should be enhanced to at least include OOV words).
- `multi-factor-binptable` Tests factored setup with binary phrase table.
- `multi-factor-drop` Test of dropping words in a multi-factor model.
- `nbest-multi-factor` Tests n-best list generation for multi-factor models
- `n-best` Test n-best filtering, ensure consistency of top scores and score components. This will require ensuring that any moses binary is capable of generating n-best lists.
- `lattice-surface` Tests lattice decoding
- `lattice-distortion` Tests lattice decoding with distortion (?)
- `confusionNet-surface-only` Tests confusion network decoding

<sup>23</sup><http://www.statmt.org/moses/cruise/>

- `confusionNet-multi-factor` Tests confusion network decoding with multiple factors
- `lexicalized-reordering` Tests lexical reordering model
- `lexicalized-reordering-cn` Tests lexical reordering model in combination with confusion network
- `xml-markup` Tests XML Markup in input to specify translations

### 7.8.3 Running the test suite

Download the regression tests

```
git clone https://github.com/moses-smt/moses-regression-tests.git
```

From the Moses root, run

```
./bjam --with-irstlm=/path/to/irst --with-cmph=/path/to/cmph --with-regtest=/path/to/moses-regression-tests -j8
```

This will run the regression tests in parallel (`-j8`) so be sure to set a number of CPUs that your machine can handle.

If all goes well, you will see a list of the tests run, their status (hopefully pass), and a path where the results are archived.

### 7.8.4 Running an individual test

You can run a specific test by providing the name followed by `".passed"`

```
./bjam --with-irstlm=/path/to/irst --with-cmph=/path/to/cmph --with-regtest=/path/to/moses-regression-tests mert.basic.passed
```

The test name is the same as the directory name in `/path/to/moses-regression-tests/tests`.

### 7.8.5 How it works

The test suite invokes moses to decode a few sample phrases with well-known models. The output from these invocations is then scraped for information (for example, the output translation of a sentence or its probability score) which is stored in a file called `results.dat`. These values are then compared to a ground truth, which was established either by hand, from a prior moses run, or from a pharaoh run.

This will provide a point-by-point analysis of each failure or success in the test as well as information.

**Note:** Since the test suite relies on the output of moses, changes to the output format may result in broken tests. If you make changes that affect presentation only, you will need to update the testing filters (which convert the raw moses output into the `results.dat` format).

### 7.8.6 Writing regression tests

Writing regression tests is easy, but since these tests must be able to be run anywhere, it is important to keep a few things in mind. First, check out the regression-testing module from the Git repository. Settle on what you would like to test in and choose a test name (henceforth, this name will be `TEST-NAME`). Create a directory for it under regression testing.

Place the following into the directory `regression-testing/tests/TEST-NAME`:

- `to-translate`, which contains the text that will be translated by moses.
- `moses.ini`. This `moses.ini` file should have *no absolute paths*. All paths should be expressed in terms of the variables `${LM_PATH}` and `${MODELS_PATH}`.
- The filter files, `filter-stderr` and `filter-stdout`. These files should read from `STDIN` and write results of the form `KEY = value` to `STDOUT`. No other output should be generated. Numeric values (such as times) that do not require exact matches can have the form `KEY ~ value`. These files are the trickiest part about writing a new regression test. However, they allow great flexibility in verifying specific aspects of a decoding run.
- `truth/results.txt` This file should have the values (as produced by `filter-stderr` and `filter-stdout`) that are expected from the test run.

If you need to add language models, phrase tables, generation tables or anything like this, you will need to increment the required data version number in `MosesRegressionTesting.pm`. Then, you will need to create a new `.tgz` file that contains the data for all the tests (the data dependencies are not checked into the Git repository because they are extremely large). This must then be made available for download.

*Subsection last modified on October 31, 2015, at 10:40 PM*

# 8

## Reference

### 8.1 Frequently Asked Questions

#### 8.1.1 My system is taking a really long time to translate a sentence. What can I do to speed it up ?

The single best thing you can do is to binarize the phrase tables and language models. See question below also.

#### 8.1.2 The system runs out of memory during decoding.

Filter and binarize your phrase tables. Binarize your language models using the IRSTLM. Binarize your lexicalized re-ordering table.

Binarizing the phrase table helps decrease memory usage as only phrase pairs that are needed for each sentence are read from file into memory. Similarly for language models and lexicalized reordering models.

This webpage (Section 4.3) tell you how to binarize the models.

#### 8.1.3 I would like to point out a bug / contribute code.

We are always grateful for bug reports and code contribution. Send it to an existing Moses developer you work with, or send it to Hieu Hoang at Edinburgh University.

If you want to check it code yourself, create a github account here<sup>1</sup>

Then ask one of the project admins to add you to the Moses project. The admins are currently

- Barry Haddow
- Hieu Hoang
- Nicola Bertoldi
- Ondrej Bojar
- Kenneth Heafield

We will probably ask to code review you a few times before giving you free reign. However, there is less oversight if you intend to work on your own branch, rather than the trunk.

---

<sup>1</sup><https://github.com/>

### 8.1.4 How can I get an updated version of Moses ?

The best way is using git.

From the command line, type

```
git pull
```

Or use whatever GUI client you have.

### 8.1.5 What changed in the latest release of Moses?

See Releases (Section 2.4)

### 8.1.6 I am an undergrad/masters student looking for a project in SMT. What should I do?

Email the mailing list with the title: 'Code monkey available. Will work for peanuts' ! Seriously, there's lots and lots of projects available. There has been 3-4 months projects in the past which have made a significant contribution to the community and have been integrated into the Moses toolkit. Your contribution will be grateful appreciated. Talk to your professor in the first instance, then talk to us. We maintain a list of interesting projects (Section 1.3).

### 8.1.7 What do the 5 numbers in the phrase table mean?

See the section on phrase scoring (Section 5.9)

### 8.1.8 What OS does Moses run on?

It depends on which part.

The decoder can be compiled and run on Linux (32 and 64-bits), Windows, Cygwin, Mac OSX (Intel and PowerPC). Unconfirmed reports of the decoder running on Solaris and BSD too.

The training and tuning scripts are regularly run on Linux (32 and 64-bits), and occasionally on Mac (Intel). The whole of the Moses pipeline should also run on Windows under Cygwin, however, this has not been confirmed. If you are able to run under Windows/Cygwin, please let us know and we can update this FAQ.

When running on non-Linux platforms, beware of the following issues:

- File system case-sensitivity
- zcat, gzip command line programs missing
- Old GIZA++ versions only compilable by specific gcc versions
- Availability of Sun Grid Engine

Therefore, the only realistic OS to run the whole SMT pipeline on is Linux and Intel Mac.



### 8.1.9 Can I use Moses on Windows ?

Yes. Moses compiles and runs in Cygwin exactly the same way as on Linux

There are a proviso though:

Cygwin is 32-bit, even on 64 bit windows. The binary language models (KenLM, IRSTLM) need 64 bit to work with language models larger than about 2GB. This is the same as for 32 bit Linux.

### 8.1.10 Do I need a computer cluster to run experiments?

The Moses toolkit uses SGE (Sun Grid Engine) cluster to parallelize tasks. Even though it is not strictly necessary to use a cluster to run your experiments, it is highly advisable to get your experiments to run faster.

The most CPU intensive task is the tuning of the weights (MERT tuning). As an indication, a Europarl trained model, using 2000 sentences for tuning, takes 1-2 days to tune using 15 CPUs. 10-15 iterations are typical.

### 8.1.11 I have compiled Moses, but it segfaults when running.

Moses should not segfault, so the Moses developers would like to hear about it.

First of all, try to identify the fault yourself. The most common error is the ini file is not correct, or the sentence input is badly formatted.

If necessary, you can debug the system by stepping through the source code. We put a lot of effort into making the code easy to read and debug. Also, the decoder comes with Visual Studio and XCode project file to help you debug in a GUI environment.

If you still can not find the solution, email the mailing list. Its useful to attach the ini file, the output just before it crashes, and any other info that you think may be useful to help resolve the problem.

### 8.1.12 How do I add a new feature function to the decoder?

This is now documented in its own section (Section 7.6).

### 8.1.13 Compiling with SRILM or IRSTLM produces errors.

Firstly, make sure SRILM/IRSTLM themselves have compiled successfully. You should see be a libflm.a/libdstruct.a etc (for SRILM), or libirstlm.a. If these are not available, then something went wrong. SRILM and IRSTLM are external libraries so the Moses developers have limited say and knowledge of them.

SRI or IRST LM both have their own mailing list where you can ask questions if you have problem compiling them. See here for details:

- SRILM<sup>2</sup>
- IRSTLM<sup>3</sup>

If Moses still does not compile successfully, look at the compile error to see where the compiler is trying to find these external libraries. Occasionally (especially when compiling on 64-bit machines), Moses expects the .a file in 1 sub-directory but they are in another. This is easily solved by moving copying the .a file to the place where Moses expect it to be.

#### 8.1.14 I am trying to use Moses to create a web page to do translation.

There is a subproject in Moses, in contrib/web , which allows you to set up a web page to translate other web pages. Its written in Perl and the installation is non-trivial. Follow the instructions carefully.

It doesn't translate ad-hoc sentences. If you have some code which allow translation of ad-hoc sentences, please share it with us !

#### 8.1.15 How can a create a system that translate both ways, ie. X-to-Y as well as Y-to-X ?

You need to do everything twice, and run 2 decoders. There is a lot of overlap between them, but the toolkit is designed to go 1 way at a time.

#### 8.1.16 PhraseScore dies with signal 11 - why?

This may happen means because you have a null byte in your data. Look at line 2 of model/lex.f2e.

Try this to find lines with null bytes in your original data:

```
grep -Pc '[\000]' <files ...>
```

(If your grep does not support Perl-style regular expression syntax (-P), you will have to express that a different way.)

If this turns out to be the problem, and you don't want to run GIZA++ again from scratch, you can try the following:

First go into working-dir/model and delete everything but the following:

<sup>2</sup><http://www.speech.sri.com/mailman/listinfo/srilm-user>

<sup>3</sup><https://list.fbk.eu/sympa/subscribe/user-irstlm>

```
aligned.grow-diag-final-and
aligned.0.fr
aligned.0.en
lex.0-0.n2f
lex.0-0.f2n
```

Now run this fragment of Perl:

```
perl -i.BAD -pe 's/[\000]/NULLBYTE/g;' aligned.0* lex.0*
```

This will replace every null byte in those four files, saving the old version out to \*.BAD. (This may be overkill, for instance if only the foreign side has the problem.)

Now restart the Moses training script with the same invocation as before, but tell it to start at step 5:

```
train-model.perl ... --first-step 5
```

### 8.1.17 Does Moses do Hierarchical decoding, like Hiero etc?

Yes. Check the Syntax Tutorial (Section 3.3).

### 8.1.18 Can I use Moses in proprietary software ?

Moses is licensed under the LGPL. See here<sup>4</sup> for a thorough explanation of what this means.

Basically, if you are just using Moses unchanged, there are no license issues. You can also use the Moses library (libmoses.a) in your own applications. But if you want to distribute a modified version of Moses, you have to distribute the source code to the modifications.

### 8.1.19 GIZA++ crashes with error "parameter 'cooccurrencefile' does not exist."

You have a version of GIZA++ which does not support cooccurrence files. To add support for cooccurrence files, you need to edit the GIZA++ Makefile and add the flag `-DBINARY_SEARCH_FOR_TTABLE` to `CFLAGS_OPT`. Then you should rebuild GIZA++.

---

<sup>4</sup><http://www.gnu.org/licenses/gpl-faq.html>

### 8.1.20 Running regenerate-makefiles.sh gives me lots of errors about \*GREP and \*SED macros

You should not be running this script. Moses moved from autotools to bjam in Autumn 2011.

### 8.1.21 Running training I got the following error "\*\*\* buffer overflow detected \*\*\*: ./giza-pp/GIZA++-v2/GIZA++ terminated"

This error occurs during the word alignment step and is related to GIZA++, and not directly to the Moses Toolkit. Nevertheless, the solution is described here<sup>5</sup>.

### 8.1.22 I retrained my model and got different BLEU scores. Why?

In general, Machine Translation training is non-convex. this means that there are multiple solutions and each time you run a full training job, you will get different results. In particular, you will see different results when running GIZA++ (any flavour) and MERT.

The best way to deal with this (and most expensive) would be to run the full pipe-line, from scratch and multiple times. This will give you a feel for variance --differences in results. In general, variance arising from GIZA++ is less damaging than variance from MERT.

To reduce variance it is best to use as much data as possible at each stage. It is possible to reduce this variability by using better machine learning, but in general it will always be there.

Another strategy is to fix everything once you have a set of good weights and never rerun MERT. Should you need to change say the language model, you will then manually alter the associated weight. This will mean stability, but at the obvious cost of generality. it is also ugly.

See Clark et al.<sup>6</sup> for a discussion of some of these issues.

### 8.1.23 I specified ranges for mert weights, but it returned weights which are out-with those ranges

The ranges that you pass to `mert-moses.pl` (using the `--range` argument) are only used in the random restarts, so serve to guide mert rather than restrict it.

### 8.1.24 Who do I ask if my question has not been answered by this FAQ?

Search the mailing list archive<sup>7</sup>. If you still do not find the answer, then send questions to the mailing list 'moses-support'. However, you have to sign up<sup>8</sup> before emailing.

*Subsection last modified on July 28, 2013, at 09:55 AM*

---

<sup>5</sup><http://www.statmt.org/moses/?n=Moses.GizappBufferOverflow>

<sup>6</sup><http://www.cs.cmu.edu/~jhclark/pubs/significance.pdf>

<sup>7</sup><http://blog.gmane.org/gmane.comp.nlp.moses.user>

<sup>8</sup><http://mailman.mit.edu/mailman/listinfo/moses-support>

## 8.2 Reference: All Decoder Parameters

- `-beam-threshold (b)`: threshold for threshold pruning
- `-cache-path`: ?
- `-config (-f)`: location of the configuration file
- `-constraint`: Target sentence to produce
- `-cube-pruning-diversity (-cbd)`: How many hypotheses should be created for each coverage. (default = 0)
- `-cube-pruning-pop-limit (-cbp)`: How many hypotheses should be popped for each stack. (default = 1000)
- `-distortion`: configurations for each factorized/lexicalized reordering model.
- `-distortion-file`: source factors (0 if table independent of source), target factors, location of the factorized/lexicalized reordering tables
- `-distortion-limit (-dl)`: distortion (reordering) limit in maximum number of words (0 = monotone, -1 = unlimited)
- `-drop-unknown (-du)`: drop unknown words instead of copying them
- `-early-discarding-threshold (-edt@@)`: threshold for constructing hypotheses based on estimate cost
- `-factor-delimiter (-fd)`: specify a different factor delimiter than the default
- `-generation-file`: location and properties of the generation table
- `-include-alignment-in-n-best`: include word alignment in the n-best list. default is false
- `-input-factors`: list of factors in the input
- `-input-file (-i)`: location of the input file to be translated
- `-inputtype`: text (0), confusion network (1) or word lattice (2)
- `-labeled-n-best-list`: print out labels for each weight type in n-best list. default is true
- `-lmodel-dub`: dictionary upper bounds of language models
- `-lmodel-file`: location and properties of the language models
- `-lmstats (-L)`: (1/0) compute LM backoff statistics for each translation hypothesis
- `-mapping`: description of decoding steps
- `-max-partial-trans-opt`: maximum number of partial translation options per input span (during mapping steps)
- `-max-phrase-length`: maximum phrase length (default 20)
- `-max-trans-opt-per-coverage`: maximum number of translation options per input span (after applying mapping steps)
- `-mbr-scale`: scaling factor to convert log linear score probability in MBR decoding (default 1.0)
- `-mbr-size`: number of translation candidates considered in MBR decoding (default 200)
- `-minimum-bayes-risk (-mbr)`: use minimum Bayes risk to determine best translation
- `-monotone-at-punctuation (-mp)`: do not reorder over punctuation
- `-n-best-factor`: factor to compute the maximum number of contenders (=factor\*nbest-size). value 0 means infinity, i.e. no threshold. default is 0
- `-n-best-list`: file and size of n-best-list to be generated; specify - as the file in order to write to STDOUT
- `-output-factors`: list if factors in the output
- `-output-search-graph (-osg)`: Output connected hypotheses of search into specified filename

- `-output-word-graph (-owg)`: Output stack info as word graph. Takes filename, 0=only hypos in stack, 1=stack + nbest hypos
- `-persistent-cache-size`: maximum size of cache for translation options (default 10,000 input phrases)
- `-phrase-drop-allowed (-da)`: if present, allow dropping of source words
- `-print-alignment-info`: Output word-to-word alignment into the log file. Word-to-word alignments are taken from the phrase table if any. Default is false
- `-print-alignment-info-in-n-best`: Include word-to-word alignment in the n-best list. Word-to-word alignments are taken from the phrase table if any. Default is false
- `-recover-input-path (-r)`: (confusion net/word lattice only) - recover input path corresponding to the best translation
- `-report-all-factors`: report all factors in output, not just first
- `-report-segmentation (-t)`: report phrase segmentation in the output
- `-search-algorithm`: Which search algorithm to use. 0=normal stack, 1=cube pruning (default = 0)
- `-stack (-s)`: maximum stack size for histogram pruning
- `-stack-diversity (-sd)`: minimum number of hypothesis of each coverage in stack (default 0)
- `-time-out`: seconds after which is interrupted (-1=no time-out, default is -1)
- `-translation-details (-T)`: for each best translation hypothesis, print out details about what source spans were used, dropped
- `-translation-option-threshold (-tot)`: threshold for translation options relative to best for input phrase
- `-ttable-file`: location and properties of the translation tables
- `-use-alignment-info`: Use word-to-word alignment: actually it is only used to output the word-to-word alignment. Word-to-word alignments are taken from the phrase table if any. Default is false.
- `-use-persistent-cache`: cache translation options across sentences (default true)
- `-verbose (-v)`: verbosity level of the logging
- `-weight-d (-d)`: weight(s) for distortion (reordering components)
- `-weight-e (-e)`: weight for word deletion
- `-weight-file (-wf)`: file containing labeled weights
- `-weight-generation (-g)`: weight(s) for generation components
- `-weight-i (-I)`: weight for word insertion
- `-weight-l (-lm)`: weight(s) for language models
- `-weight-t (-tm)`: weights for translation model components
- `-weight-w (-w)`: weight for word penalty
- `-xml-input (-xi)`: allows markup of input with desired translations and probabilities. values can be 'pass-through' (default), 'inclusive', 'exclusive', 'ignore'

*Subsection last modified on August 25, 2014, at 09:41 AM*

### 8.3 Reference: All Training Parameters

- `--root-dir` -- root directory, where output files are stored
- `--corpus` -- corpus file name (full pathname), excluding extension
- `--e` -- extension of the English corpus file

- `--f` -- extension of the foreign corpus file
- `--lm` -- language model: `<factor>:<order>:<filename>` (option can be repeated)
- `--first-step` -- first step in the training process (default 1)
- `--last-step` -- last step in the training process (default 7)
- `--parts` -- break up corpus in smaller parts before GIZA++ training
- `--corpus-dir` -- corpus directory (default `$ROOT/corpus`)
- `--lexical-dir` -- lexical translation probability directory (default `$ROOT/model`)
- `--model-dir` -- model directory (default `$ROOT/model`)
- `--extract-file` -- extraction file (default `$ROOT/model/extract`)
- `--giza-f2e` -- GIZA++ directory (default `$ROOT/giza.$F-$E`)
- `--giza-e2f` -- inverse GIZA++ directory (default `$ROOT/giza.$E-$F`)
- `--alignment` -- heuristic used for word alignment: `intersect`, `union`, `grow`, `grow-final`, `grow-diag`, `grow-diag-final` (default), `grow-diag-final-and`, `srctotgt`, `tgttosrc`
- `--max-phrase-length` -- maximum length of phrases entered into phrase table (default 7)
- `--giza-option` -- additional options for GIZA++ training
- `--verbose` -- prints additional word alignment information
- `--no-lexical-weighting` -- only use conditional probabilities for the phrase table, not lexical weighting
- `--parts` -- prepare data for GIZA++ by running `snt2cooc` in parts
- `--direction` -- run training step 2 only in direction 1 or 2 (for parallelization)
- `--reordering` -- specifies which reordering models to train using a comma-separated list of config-strings, see `FactoredTraining.BuildReorderingModel` (Section 5.10). (default distance)
- `--reordering-smooth` -- specifies the smoothing constant to be used for training lexicalized reordering models. If the letter "u" follows the constant, smoothing is based on actual counts. (default 0.5)
- `--alignment-factors` --
- `--translation-factors` --
- `--reordering-factors` --
- `--generation-factors` --
- `--decoding-steps` --

### 8.3.1 Basic Options

A number of parameters are required to point the training script to the correct training data. We will describe them in this section. Other options allow for partial training runs and alternative settings.

As mentioned before, you want to create a special directory for training. The path to that directory has to be specified with the parameter `--root-dir`.

The root directory has to contain a sub directory (called `corpus`) that contains the training data. The training data is a parallel corpus, stored in two files, one for the English sentences, one for the foreign sentences. The corpus has to be sentence-aligned, meaning that the 1624th line in the English file is the translation of the 1624th line in the foreign file.

Typically, the data is lowercased, no empty lines are allowed, and having multiple spaces between words may cause problems. Also, sentence length is limited to 100 words per sentence.

The sentence length ratio for a sentence pair can be at most 9 (i.e, having a 10-word sentence aligned to a 1-word sentence is disallowed). These restrictions on sentence length are caused by GIZA++ and may be changed (see below).

The two corpus files have a common file stem (say, euro) and extensions indicating the language (say, en and de). The file stem (`--corpus-file`), and the language extensions (`--e` and `--f`) have to be specified to the training script.

In summary, the training script may be invoked as follows:

```
train-model.perl --root-dir . --f de --e en --corpus corpus/euro >& LOG
```

After training, typically the following files can be found in the root directory (note the time stamps that tell you something about how much time was spent on each step took for this data):

```
> ls -lh *
-rw-rw-r-- 1 koehn user 110K Jul 13 21:49 LOG

corpus:
total 399M
-rw-rw-r-- 1 koehn user 104M Jul 12 19:58 de-en-int-train.snt
-rw-rw-r-- 1 koehn user 4.2M Jul 12 19:56 de.vcb
-rw-rw-r-- 1 koehn user 3.2M Jul 12 19:42 de.vcb.classes
-rw-rw-r-- 1 koehn user 2.6M Jul 12 19:42 de.vcb.classes.cats
-rw-rw-r-- 1 koehn user 104M Jul 12 19:59 en-de-int-train.snt
-rw-rw-r-- 1 koehn user 1.1M Jul 12 19:56 en.vcb
-rw-rw-r-- 1 koehn user 793K Jul 12 19:56 en.vcb.classes
-rw-rw-r-- 1 koehn user 614K Jul 12 19:56 en.vcb.classes.cats
-rw-rw-r-- 1 koehn user 94M Jul 12 18:08 euro.de
-rw-rw-r-- 1 koehn user 84M Jul 12 18:08 euro.en

giza.de-en:
total 422M
-rw-rw-r-- 1 koehn user 107M Jul 13 03:57 de-en.A3.final.gz
-rw-rw-r-- 1 koehn user 314M Jul 12 20:11 de-en.cooc
-rw-rw-r-- 1 koehn user 2.0K Jul 12 20:11 de-en.gizacfg

giza.en-de:
total 421M
-rw-rw-r-- 1 koehn user 107M Jul 13 11:03 en-de.A3.final.gz
-rw-rw-r-- 1 koehn user 313M Jul 13 04:07 en-de.cooc
-rw-rw-r-- 1 koehn user 2.0K Jul 13 04:07 en-de.gizacfg

model:
```



```
total 2.1G
-rw-rw-r-- 1 koehn user 94M Jul 13 19:59 aligned.de
-rw-rw-r-- 1 koehn user 84M Jul 13 19:59 aligned.en
-rw-rw-r-- 1 koehn user 90M Jul 13 19:59 aligned.grow-diag-final
-rw-rw-r-- 1 koehn user 214M Jul 13 20:33 extract.gz
-rw-rw-r-- 1 koehn user 212M Jul 13 20:35 extract.inv.gz
-rw-rw-r-- 1 koehn user 78M Jul 13 20:23 lex.f2n
-rw-rw-r-- 1 koehn user 78M Jul 13 20:23 lex.n2f
-rw-rw-r-- 1 koehn user 862 Jul 13 21:49 pharaoh.ini
-rw-rw-r-- 1 koehn user 1.2G Jul 13 21:49 phrase-table
```

### Summary

- `--root-dir` -- root directory, where output files are stored
- `--corpus` -- corpus, expected in `$ROOT/corpus`
- `--e` -- extension of the English corpus file
- `--f` -- extension of the foreign corpus file
- `--lm` -- language model file

### 8.3.2 Factored Translation Model Settings

More on factored translation models in the Overview (Section 5.1).

#### Summary

- `--alignment-factors` --
- `--translation-factors` --
- `--reordering-factors` --
- `--generation-factors` --
- `--decoding-steps` --

### 8.3.3 Lexicalized Reordering Model

More on lexicalized reordering on the description of Training step 7: build reordering model (Section 5.10).

#### Summary

- `--reordering` --
- `--reordering-smooth` --

### 8.3.4 Partial Training

You may have better ideas how to do word alignment, extract phrases or score phrases. Since the training is modular, you can start training at any of the seven training steps `--first-step` and end it at any subsequent step `--last-step`.

Again, the nine training steps are:

1. Prepare data
2. Run GIZA++
3. Align words
4. Get lexical translation table
5. Extract phrases
6. Score phrases
7. Build reordering model
8. Build generation models
9. Create configuration file

For instance, if you may have your own method to generate a word alignment, you want to skip these training steps and start with lexical translation table generation, you may specify this by

```
train-model.perl [...] --first-step 4
```

#### Summary

- `--first-step` -- first step in the training process (default 1)
- `--last-step` -- last step in the training process (default 7)

### 8.3.5 File Locations

A number of parameters allow you to break out of the rigid file name conventions of the training script. A typical use for this is that you want to try alternative training runs, but there is no need to repeat all the training steps.

For instance, you may want to try an alternative alignment heuristic. There is no need to rerun GIZA++. You could copy the necessary files from the corpus and the `giza.*` directories into a new root directory, but this takes up a lot of additional disk space and makes the file organization unnecessarily complicated.

Since you only need a new model directory, you can specify this with the parameter `--model-dir`, and stay within the precious root directory structure:

```
train-model.perl [...] --first-step 3 --alignment union --model-dir model-union
```

The other parameters for file and directory names fulfill similar purposes.

#### Summary

- `--corpus-dir` -- corpus directory (default `$ROOT/corpus`)
- `--lexical-dir` -- lexical translation probability directory (default `$ROOT/model`)
- `--model-dir` -- model directory (default `$ROOT/model`)
- `--extract-file` -- extraction file (default `$ROOT/model/extract`)

- `--giza-f2e` -- GIZA++ directory (default `$ROOT/giza.F - E}`)
- `--giza-e2f` -- inverse GIZA++ directory (default `$ROOT/giza.E - F)`)

### 8.3.6 Alignment Heuristic

A number of different word alignment heuristics are implemented, and can be specified with the parameter `--alignment`. The options are:

- `intersect` -- the intersection of the two GIZA++ alignments is taken. This usually creates a lot of extracted phrases, since the unaligned words create a lot of freedom to align phrases.
- `union` -- the union of the two GIZA++ alignments is taken
- `grow-diag-final` -- the default heuristic
- `grow-diag` -- same as above, but without a call to function `FINAL()` (see background to word alignment).
- `grow` -- same as above, but with a different definition of *neighboring*. Now diagonally adjacent alignment points are excluded.
- `grow` -- no diagonal neighbors, but with `FINAL()`

Different heuristic may show better performance for a specific language pair or corpus, so some experimentation may be useful.

Summary

- `--alignment` -- heuristic used for word alignment: `intersect`, `union`, `grow`, `grow-final`, `grow-diag`, `grow-diag-final` (default)

### 8.3.7 Maximum Phrase Length

The maximum length of phrases is limited to 7 words. The maximum phrase length impacts the size of the phrase translation table, so shorter limits may be desirable, if phrase table size is an issue. Previous experiments have shown that performance increases only slightly when including phrases of more than 3 words.

Summary

- `--max-phrase-length` -- maximum length of phrases entered into phrase table (default 7)

### 8.3.8 GIZA++ Options

GIZA++ takes a lot of parameters to specify the behavior of the training process and limits on sentence length, etc. Please refer to the corresponding documentation for details on this.

Parameters can be passed on to GIZA++ with the switch `--giza-option`.

For instance, if you want to change the number of iterations for the different IBM models to 4 iterations of Model 1, 0 iterations of Model 2, 4 iterations of the HMM Model, 0 iterations of Model 3, and 3 iterations of Model 4, you can specify this by

```
train-model.perl [...] --giza-option m1=4,m2=0,mh=4,m3=0,m4=3
```

#### Summary

- `--giza-option` -- additional options for GIZA++ training

### 8.3.9 Dealing with large training corpora

Training on large training corpora may become a problem for the GIZA++ word alignment tool. Since it stores the word translation table in memory, the size of this table may become too large for the available RAM of the machine. For instance, the data sets for the NIST Arabic-English and Chinese-English competitions require more than 4 GB of RAM, which is a problem for current 32-bit machines.

This problem can be remedied to some degree by a more efficient data structure in GIZA++, which requires the run of `snt2cooc` in advance on the corpus in parts and the merging on the resulting output. All you need to know is that running the training script with the option `--parts n`, e.g. `--parts 3` may allow you to train on a corpus that was too large for a regular run.

Somewhat related to this problem caused by large training corpora is the problem of the large run time of GIZA++. It is possible to run the two GIZA++ separately on two machines with the switch `--direction`. When running one of the runs on one machine with `--direction 1` and the other run on a different machine or CPU with `--direction 2`, the processing time for training step 2 can be cut in half.

#### Summary

- `--parts` -- prepare data for GIZA++ by running `snt2cooc` in parts
- `--direction` -- run training step 2 only in direction 1 or 2 (for parallelization)

*Subsection last modified on July 28, 2013, at 09:45 AM*

## 8.4 Glossary

*(based on excerpts from the "DoMY Glossary" in Do Moses Yourself Community Edition by Precision Translation Tools Co., Ltd.)*

This glossary includes common terms that are helpful for new users of statistical machine translation (SMT) and the open source Moses Decoder project.

**aligned data:** Aligned data are the elements of a parallel corpus consisting of two or more languages. Each element in one language matches the corresponding element in the other language(s). The elements, sometimes called segments, can be block-aligned, paragraph-aligned, sentence-aligned, phrase-aligned or token-aligned.

**alignment process:** There are two alignment processes. In corpus preparation, the alignment process creates aligned data. During training, the alignment process uses a program such as MGIZA++ to create word alignment files.

**BLEU score:** BLEU stands for Bi-Lingual Evaluation Understudy". A BLEU score indicates how closely the token sequences in one set of data, such as machine translation output, correlate with (match) the token sequences in another set of data, such as a reference human translation. See: evaluation process

**corpus preparation:** Corpus preparation is the general process to extract, transform, categorize various documents from their original purpose to and align the resulting data into a parallel corpus for training a translation model.

**development (dev) set:** See "tuning set"

**eval set:** See "test set"

**evaluation process:** The evaluation process uses a translation model of components created in the training process and configured with the tuning process to translate several thousand source language sentences in the eval set. This process then compares the resulting machine translations to reference translations, also in the eval set. The final BLEU score evaluation report shows how well the machine translations match the reference translations.

**hierarchical model:** SMT translation model that uses hierarchical training corpus.

**hierarchical training data:** A training corpus with each phrase annotated with the hierarchical structure of the language, such as parts of speech, word function, etc.

**language model:** A "language model" or "lm" is a statistical description of one language that includes the frequencies of token-based n-grams occurrences in a corpus. The "lm" is trained from a large monolingual corpus and saved as a file. The language model file is a required component of every translation model. Moses uses language model to select the most "probably" target language sentence from a large set of "possible" translations it generated using the phrase table and reordering table.

**language model types:** Language model files contain statistical data generated by one of various programs. Moses Decoder can use language model file types including: KenLM SRILM, RandLM and IRSTLM. SRILM, RandLM and IRSTLM toolkits include tools that train the new language model files. KenLM, however, only reads ARPA standard language model files which can be created by SRILM, IRSTLM.

**Moses configuration file:** The Moses configuration file is a text file created during the tuning process. The file contains the paths to the phrase table(s), reordering table, language model(s) with other codes and numeric values that control how the Moses Decoder works.

**n-grams:** An n-gram is a subsequence of n number of (1, 2, 3, etc) items in a larger sequence. In an lm n-grams are sequences of tokens. In phrase tables and reordering tables, n-grams are sequences of pairs of source and target language tokens.

**parallel corpus or parallel data:** A linguistic corpus of two or more languages where each element in one language corresponds to an element with the same meaning in the other language(s). The original, authored language is identified as the source language. Non-source

languages are referred to as "target" languages. For Moses SMT, parallel data takes the form of one source and one target language text file where both files contain corresponding translation of sentences line by line.

**phrase table:** A "phrase table" is a statistical description of a parallel corpus of source-target language sentence pairs. The frequencies that n-grams in a source language text co-occur with n-grams in a parallel target language text represent the probability that those source-target paired n-grams will occur again in other texts similar to the parallel corpus. In practical terms, the phrase table is a file created during the training process and saved in the translation model folder. It functions as a sophisticated dictionary between the source and target languages. Phrase tables and reordering tables are translation model components.

**pipeline:** A "pipeline" is a toolchain of processes connected by standard streams, so that the output of each process (stdout) feeds directly as input (stdin) to the next one.

**recaser model:** A recaser model is a special translation model translates lower cased data to "natural" cased text (upper and lower casing).

**reordering table:** A "reordering table" contains the statistical frequencies that describe the changes in word order between source and target languages, such as "big house" versus "house big". In practical terms, a "reordering table" is a file created during the training process and saved as a file in the model folder. The reordering table is translation model components.

**source language:** The source language is the language of the text that is to be translated. Typically, this is the authored language of the text. The source language is the same as the TMX specification "srclang" attribute of the <tu> tag.

**target language:** The target language is the language the source language text should be translated to.

**test set:** A pair of source and target language data, typically containing of several thousands of pairs used in the evaluation process.

**tokenization:** Tokenization is the process of separating words from punctuation and symbols into tokens.

**tokens:** Tokens are the basic unit in a machine translation process. Tokens are a sequence of characters, such as words, punctuation or symbols, separated by a space. See: BLEU score

**toolchain:** A "toolchain" is a series of linked or "chained" programming tools used in a series where the output of an upstream tool become the input for a "downstream" tool.

**training corpus** or **training data:** A linguistic corpus with parallel data prepared for training into the phrase table and a reordering table components of a translation model.

**training process:** Training is a process in the machine learning branch of artificial intelligence field. In the training process, a system "learns" the relationships between parallel data. In SMT, the source language texts are stimuli that generate the target language text as a response. In practical terms, training starts with the bitext files and creates the phrase table and reordering table that are components of a translation model.

**translation memory:** A translation memory (TM) is parallel data that was collected for the purpose of aiding future translations.

**translation model:** A "translation model" consists of one or more phrase tables, zero or more reordering tables, one or more language models and one Moses configuration file that were created during the training and tuning processes.

**truecasing:** Truecasing replaces each words with its natural uppercase/lowercase spelling. This process typically leaves all words unchanged except for the first word in the sentence, which may be lowercased.

**tuning process:** Tuning is a process that finds the optimized configuration file settings for a translation model when used a specific purpose. The tuning process translates thousands of source language phrases in the tuning set with a translation model, compares the model's output to a set of reference human translations, and adjusts the settings with the intention to improve the translation quality. This process continues through numerous iterations. With each iteration, the tuning process repeats the steps until it reaches an optimized translation quality.

**tuning set:** A pair of source and target language data, typically containing of several thousands of pairs used in the tuning process.

**word aligner:** A word aligner is a program that created word alignment files during the word alignment process. Moses currently supports these word aligners: GIZA++, MGIZA++, and BerkeleyAligner.

**word alignment:** Word alignment process uses a word aligner to create a word alignment file during the training process.

**words:** A word is the smallest unit of meaning in a language that will stand on its own. In SMT, a word is a token created in the tokenization process that is not a punctuation or symbol.

*Subsection last modified on July 28, 2013, at 08:54 AM*